

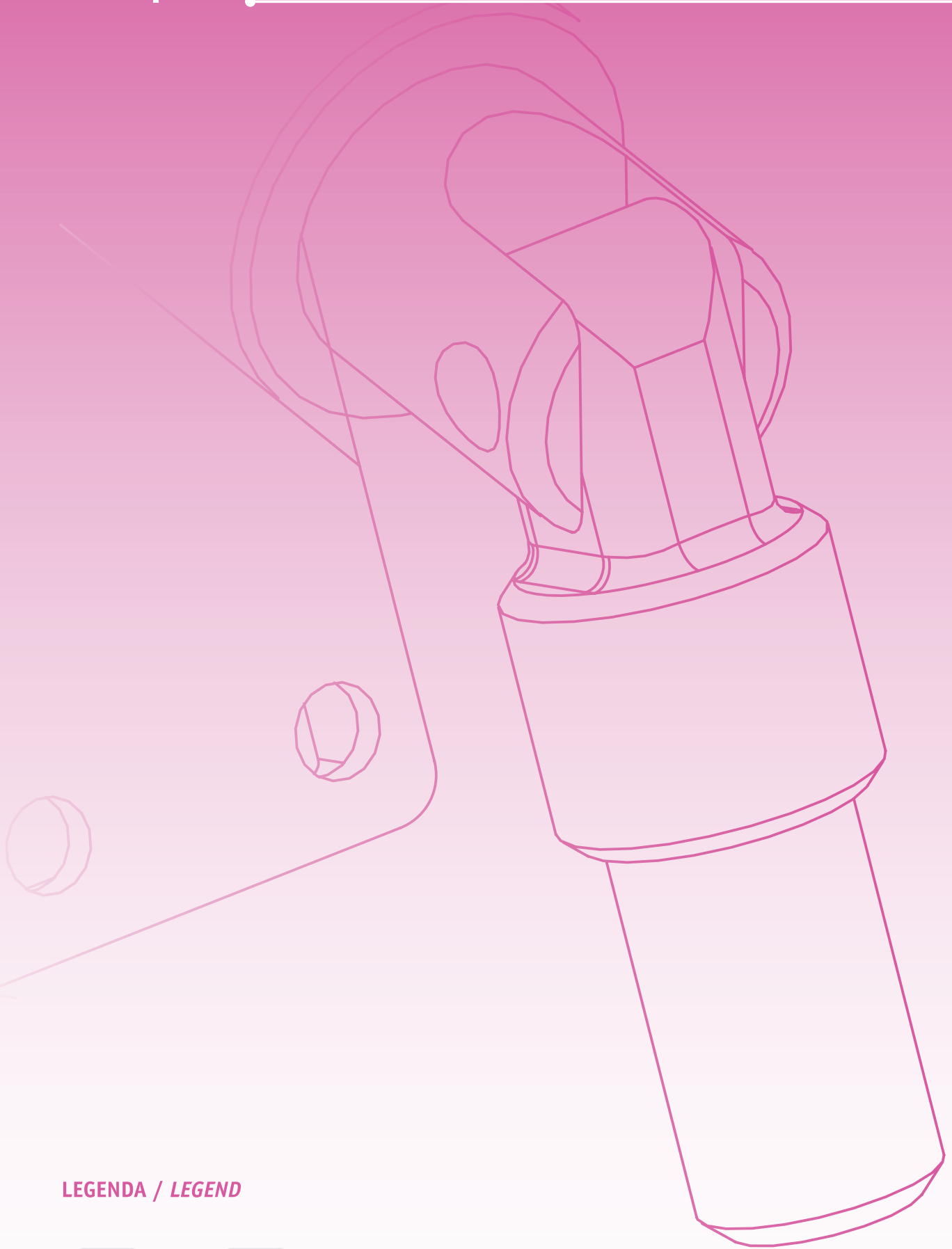



# 12 SNODI E ASTE JOINTS AND HANDCRANKS



## LEGENDA / LEGEND

. Bianco . White		. Marrone . Brown	
. Grigio . Grey		. Nero . Black	

# SNODO 45°

JOINT 45°

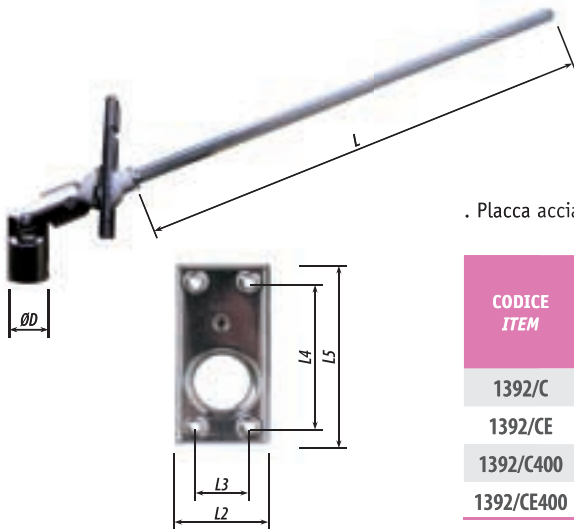
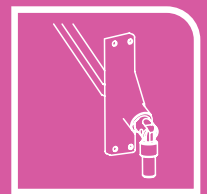

. Placca acciaio inox - Steel covering plate

CODICE ITEM	L	GRADI DEGREES	DIAMETRO DIAMETER (ØD)	L2	L3	L4	L5	SEZIONE SECTION	PZ PCS
1392/C	250	45	14	36	20	55	70	QUADRO 8 - SQUARE 8	25
1392/CE	250	45	14	36	20	55	70	ESAGONO 7 - HEXAGON 7	25
1392/C400	400	45	14	36	20	55	70	QUADRO 8 - SQUARE 8	25
1392/CE400	400	45	14	36	20	55	70	ESAGONO 7 - HEXAGON 7	25

# SNODO 45° CON PIN

JOINT 45° WITH PIN

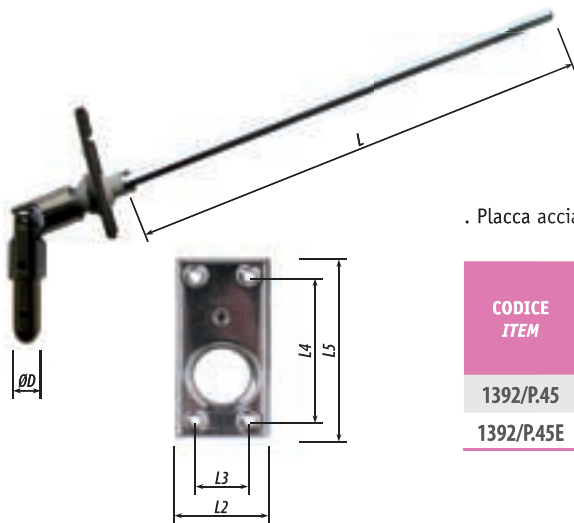

. Placca acciaio inox - Steel covering plate

CODICE ITEM	L	GRADI DEGREES	DIAMETRO DIAMETER (ØD)	L2	L3	L4	L5	SEZIONE SECTION	PZ PCS
1392/P.45	250	45	13,5	36	20	55	70	QUADRO 8 - SQUARE 8	25
1392/P.45E	250	45	13,5	36	20	55	70	ESAGONO 7 - HEXAGON 7	25

# SNODO 45° CON OCCHIOLO

JOINT 45° WITH EYE

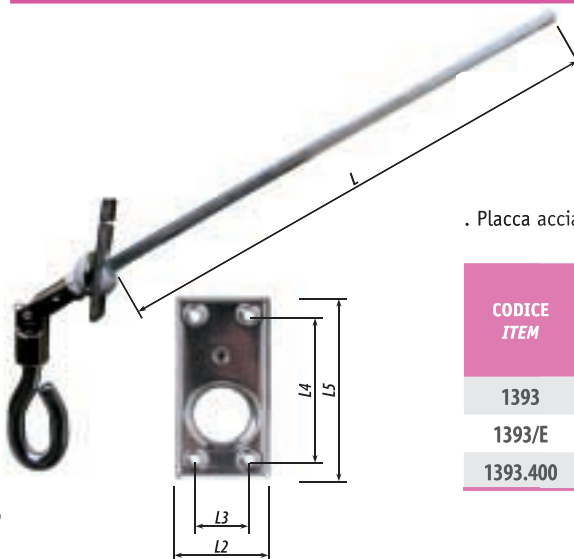

. Placca acciaio inox - Steel covering plate

CODICE ITEM	L	GRADI DEGREES	L2	L3	L4	L5	SEZIONE SECTION	PZ PCS
1393	250	45	36	20	55	70	QUADRO 8 - SQUARE 8	25
1393/E	250	45	36	20	55	70	ESAGONO 7 - HEXAGON 7	25
1393.400	400	45	36	20	55	70	QUADRO 8 - SQUARE 8	25

# SNODO 90°

JOINT 90°

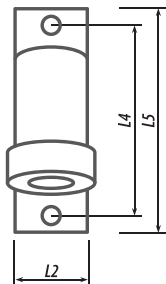
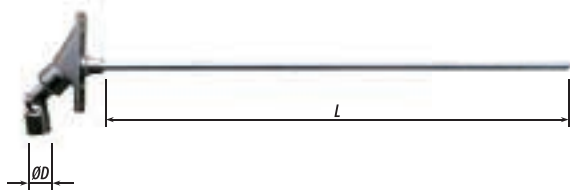
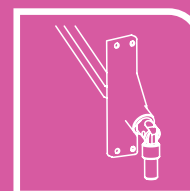

. Placca lega nichelata - Alloy steel covering plate

CODICE ITEM	L	GRADI DEGREES	DIAMETRO DIAMETER (ØD)	L2	L4	L5	SEZIONE SECTION	PZ PCS
1392/Z	400	90	14	22	73	86	QUADRO 8 - SQUARE 8	25
1392/ZE	400	90	14	22	73	86	ESAGONO 7 - HEXAGON 7	25

# SNODO 90° CON PIN

JOINT 90° WITH PIN

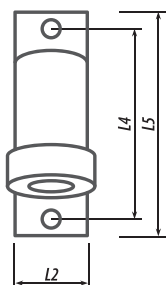
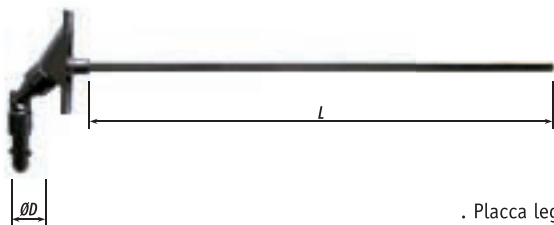

. Placca lega nichelata - Alloy steel covering plate

CODICE ITEM	L	GRADI DEGREES	DIAMETRO DIAMETER (ØD)	L2	L4	L5	SEZIONE SECTION	PZ PCS
1392/P.90	400	90	13,5	22	73	86	QUADRO 8 - SQUARE 8	25
1392/P.90E	400	90	13,5	22	73	86	ESAGONO 7 - HEXAGON 7	25

# SNODO 90° CON OCCHIOLO

JOINT 90° WITH EYE

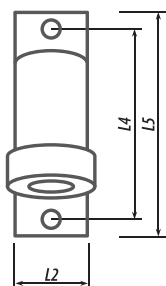
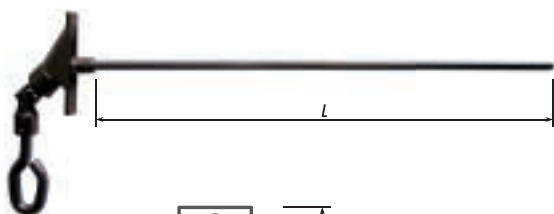

. Placca lega nichelata - Alloy steel covering plate

CODICE ITEM	L	GRADI DEGREES	L2	L4	L5	SEZIONE SECTION	PZ PCS
1393/A	400	90	22	73	86	QUADRO 8 - SQUARE 8	25
1393/AE	400	90	22	73	86	ESAGONO 7 - HEXAGON 7	25

# SNODO 45° INVISIBILE

INVISIBLE JOINT 45°

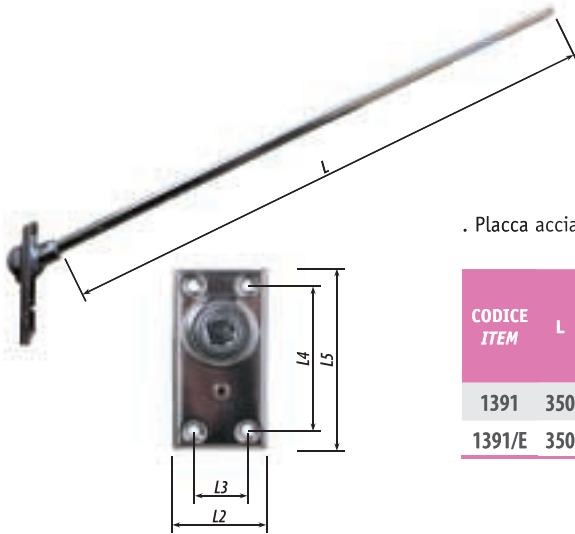
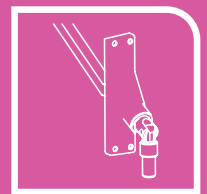

. Placca acciaio inox - Steel covering plate

CODICE ITEM	L	GRADI DEGREES	DIAMETRO DIAMETER (ØD)	L2	L3	L4	L5	SEZIONE SECTION (1)	SEZIONE SECTION (2)	PZ PCS
1391	350	45	14	36	20	55	70	QUADRO 8 - SQUARE 8	QUADRO 8 - SQUARE 8	25
1391/E	350	45	14	36	20	55	70	ESAGONO 7 - HEXAGON 7	ESAGONO 7 - HEXAGON 7	25

# SNODO 45° TIPO "BC"

JOINT 45° TYPE "BC"

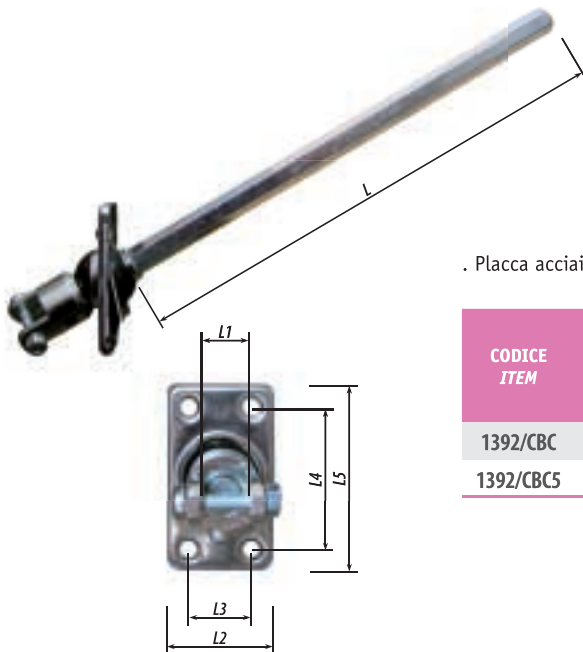

. Placca acciaio inox - Steel covering plate

CODICE ITEM	L	GRADI DEGREES	L1	L2	L3	L4	L5	SEZIONE SECTION (1)	PZ PCS
1392/CBC	200	45	13	35	20	46	60	ESAGONO 10 - HEXAGON 10	25
1392/CBC5	500	45	13	35	20	46	60	ESAGONO 10 - HEXAGON 10	25

# DOPPIO SNODO

DOUBLE JOINT

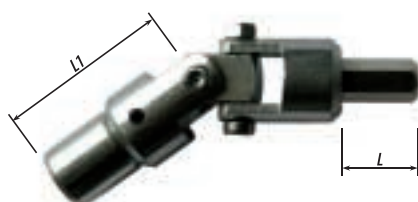

. Acciaio nichelato - Steel nickel

CODICE ITEM	L	L1	SEZIONE SECTION (1)	SEZIONE SECTION (2)	PZ PCS
1392/YBC	20	36	ESAGONO 10 - HEXAGON 10	ESAGONO 10 - HEXAGON 10	25

## DOPPIO SNODO

DOUBLE JOINT

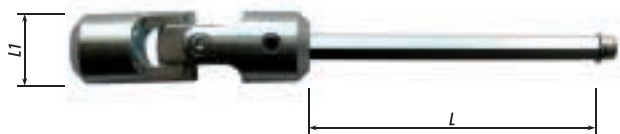
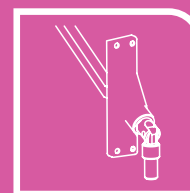

. Acciaio nichelato - Steel nickel

CODICE ITEM	L	L1	SEZIONE SECTION (1)	SEZIONE SECTION (2)	PZ PCS
K01392/Y	83	20	ESAGONO 7 - HEXAGON 7	ESAGONO 7 - HEXAGON 7	25

## CAMPANA PER ASTA BELL FOR HANDCRANK



. Lega nichelata - Alloy steel

CODICE ITEM	L	DIAMETRO DIAMETER (ØD1)	DIAMETRO DIAMETER (ØD2)	PZ PCS
1394/B.N	65	16	14	25

## PIN PER SNODO PIN FOR JOINT



. Acciaio nichelato - Alloy nickel steel

CODICE ITEM	L	DIAMETRO DIAMETER (ØD)	PZ PCS
1392/P	52	13,5	25

## OCCHIOLO PER SNODO

EYE FOR JOINT

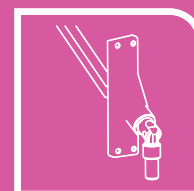

. Ferro zincato - Galvanised steel



CODICE ITEM	L	PZ PCS
1393/0.90	90	25

## GANCIO PER SNODO

HOOK FOR JOINT

. Ferro zincato - Galvanised steel



CODICE ITEM	L	PZ PCS
1393/G.90	102	25

## SNODO CON OCCHIOLO

JOINT WITH EYE



. Acciaio nichelato - Steel nickel

CODICE ITEM	L	L1	SEZIONE SECTION	PZ PCS
B0.0013ES	100	57	ESAGONO 7 - HEXAGON 7	25

## ASTA CON MANIGLIA SNODATA FERRO + SNODO 45°

STEEL HANDCRANK WITH JOINTED HANDLE + JOINT 45°

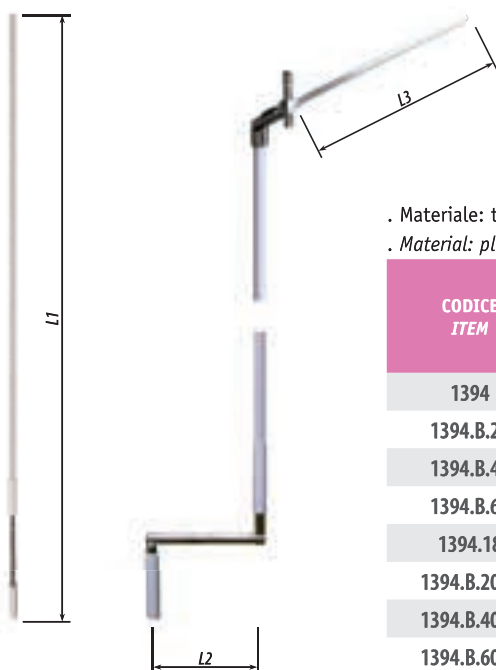
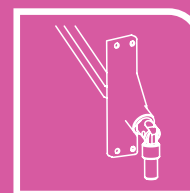

- . Materiale: tubo in acciaio rivestito di tubo pvc - maniglia in acciaio cromato
- . Material: plastic-coated steel tube - chromate steel handle

CODICE ITEM	COLORE COLOR	GRADI DEGREES	DIAMETRO DIAMETER (ØD)	L1	L2	L3	SEZIONE SECTION	PZ PCS
1394	GRIGIO - GREY	45	14	1500	150	250	QUADRO 8 - SQUARE 8	10
1394.B.20	BIANCO - WHITE	45	14	1500	150	250	QUADRO 8 - SQUARE 8	10
1394.B.40	MARRONE - BROWN	45	14	1500	150	250	QUADRO 8 - SQUARE 8	10
1394.B.60	NERO - BLACK	45	14	1500	150	250	QUADRO 8 - SQUARE 8	10
1394.18	GRIGIO - GREY	45	14	1800	150	250	QUADRO 8 - SQUARE 8	10
1394.B.2018	BIANCO - WHITE	45	14	1800	150	250	QUADRO 8 - SQUARE 8	10
1394.B.4018	MARRONE - BROWN	45	14	1800	150	250	QUADRO 8 - SQUARE 8	10
1394.B.6018	NERO - BLACK	45	14	1800	150	250	QUADRO 8 - SQUARE 8	10

## ASTA CON MANIGLIA SNODATA ALLUMINIO + SNODO 45°

ALUMINIUM HANDCRANK WITH JOINTED HANDLE + JOINT 45°

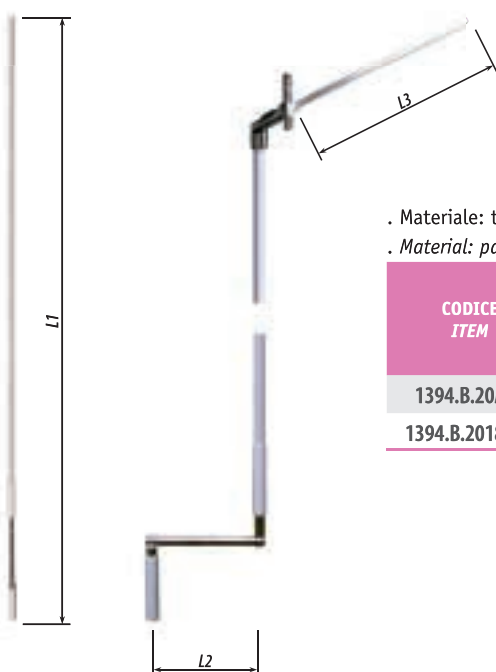

- . Materiale: tubo in alluminio verniciato - maniglia in alluminio
- . Material: painted aluminium tube - aluminium handle

CODICE ITEM	COLORE COLOR	GRADI DEGREES	DIAMETRO DIAMETER (ØD)	L1	L2	L3	SEZIONE SECTION	PZ PCS
1394.B.20ALU	BIANCO - WHITE	45	14	1500	150	250	QUADRO 8 - SQUARE 8	10
1394.B.2018ALU	BIANCO - WHITE	45	14	1800	150	250	QUADRO 8 - SQUARE 8	10

## ASTA CON MANIGLIA SNODATA FERRO + SNODO 90°

STEEL HANDCRANK WITH JOINTED HANDLE + JOINT 90°

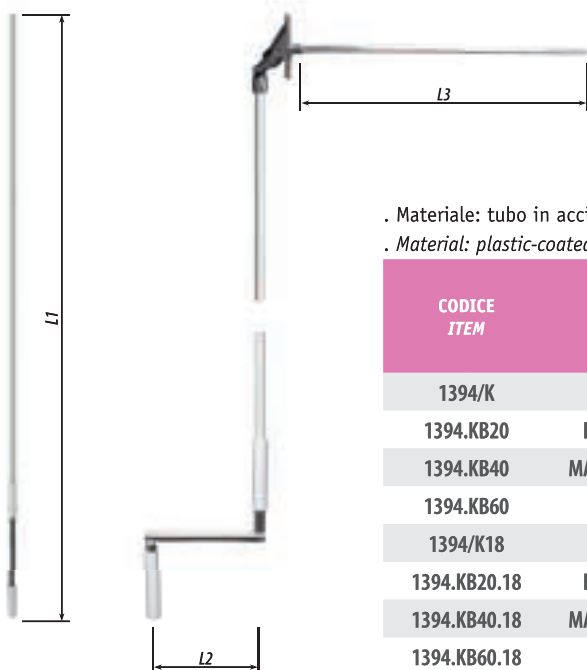
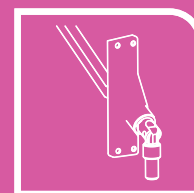

. Materiale: tubo in acciaio rivestito di tubo pvc - maniglia in acciaio cromato  
 . Material: plastic-coated steel tube - chromate steel handle

CODICE ITEM	COLORE COLOR	GRADI DEGREES	DIAMETRO DIAMETER (ØD)	L1	L2	L3	SEZIONE SECTION	PZ PCS
1394/K	GRIGIO - GREY	90	14	1500	150	400	QUADRO 8 - SQUARE 8	10
1394.KB20	BIANCO - WHITE	90	14	1500	150	400	QUADRO 8 - SQUARE 8	10
1394.KB40	MARRONE - BROWN	90	14	1500	150	400	QUADRO 8 - SQUARE 8	10
1394.KB60	NERO - BLACK	90	14	1500	150	400	QUADRO 8 - SQUARE 8	10
1394/K18	GRIGIO - GREY	90	14	1800	150	400	QUADRO 8 - SQUARE 8	10
1394.KB20.18	BIANCO - WHITE	90	14	1800	150	400	QUADRO 8 - SQUARE 8	10
1394.KB40.18	MARRONE - BROWN	90	14	1800	150	400	QUADRO 8 - SQUARE 8	10
1394.KB60.18	NERO - BLACK	90	14	1800	150	400	QUADRO 8 - SQUARE 8	10

## ASTA CON MANIGLIA SNODATA ALLUMINIO + SNODO 90°

ALUMINIUM HANDCRANK WITH JOINTED HANDLE + JOINT 90°

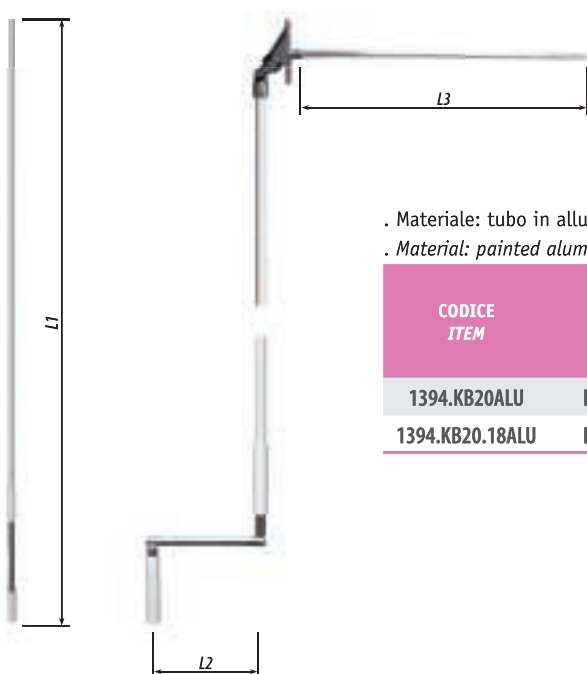

. Materiale: tubo in alluminio verniciato - maniglia in alluminio  
 . Material: painted aluminium tube - aluminium handle

CODICE ITEM	COLORE COLOR	GRADI DEGREES	DIAMETRO DIAMETER (ØD)	L1	L2	L3	SEZIONE SECTION	PZ PCS
1394.KB20ALU	BIANCO - WHITE	90	14	1500	150	400	QUADRO 8 - SQUARE 8	10
1394.KB20.18ALU	BIANCO - WHITE	90	14	1800	150	400	QUADRO 8 - SQUARE 8	10



## ASTA CON MANIGLIA SNODATA + CAMPANA

HANDCRANK WITH JOINTED HANDLE + BELL

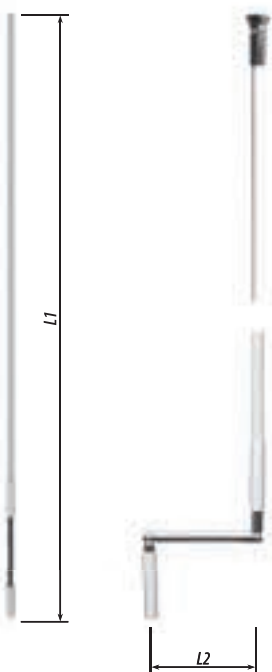
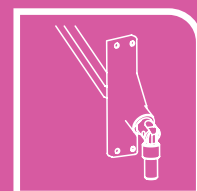

. Materiale: tubo in acciaio rivestito di tubo pvc - maniglia in acciaio cromato  
 . Material: plastic-coated steel tube - chromate steel handle

CODICE ITEM	COLORE COLOR	DIAMETRO DIAMETER (ØD)	L1	L2	PZ PCS
1394/P.150	BIANCO - WHITE	14	1500	150	10
1394/P.150.40	NERO - BLACK	14	1500	150	10
1394/P.150.60	MARRONE - BROWN	14	1500	150	10
1394/P.150.18	BIANCO - WHITE	14	1800	150	10
1394/P.150.4018	NERO - BLACK	14	1800	150	10
1394/P.150.6018	MARRONE - BROWN	14	1800	150	10

## ASTA CON MANIGLIA SNODATA + CAMPANA

HANDCRANK WITH JOINTED HANDLE + BELL

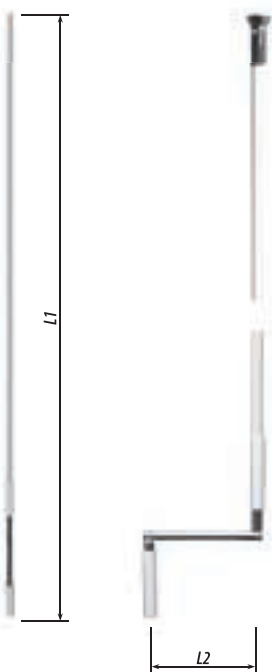

. Materiale: tubo in alluminio verniciato - maniglia in alluminio  
 . Material: painted aluminium tube - aluminium handle

CODICE ITEM	COLORE COLOR	DIAMETRO DIAMETER (ØD)	L1	L2	PZ PCS
1394/P.150ALU	BIANCO - WHITE	14	1500	150	10
1394/P.150.18ALU	BIANCO - WHITE	14	1800	150	10

## ASTA CON MANIGLIA SNODATA + GANCIO

HANDCRANK WITH JOINTED HANDLE + HOOK

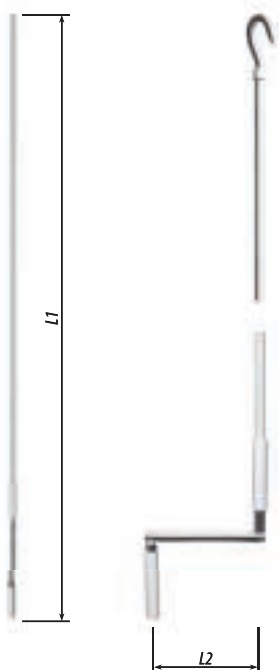
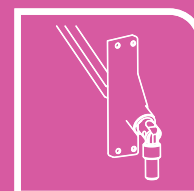

. Materiale: tubo in acciaio rivestito di tubo pvc - maniglia in acciaio cromato  
 . Material: plastic-coated steel tube - chromate steel handle

CODICE ITEM	COLORE COLOR	DIAMETRO DIAMETER (ØD)	L1	L2	PZ PCS
1394/I	GRIGIO - GREY	14	1500	150	10
1394/W	BIANCO - WHITE	14	1500	150	10
1394/L	GRIGIO - GREY	14	1800	150	10
1394/WB	BIANCO - WHITE	14	1800	150	10

## ASTA CON MANIGLIA SNODATA FERRO

STEEL HANDCRANK WITH JOINTED HANDLE

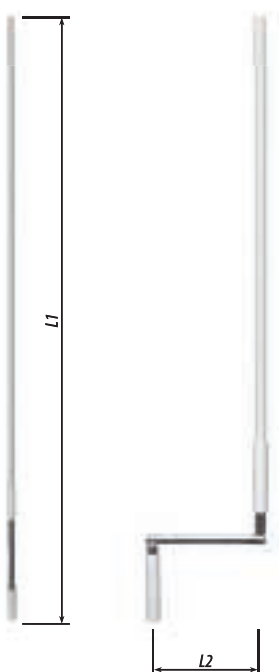

. Materiale: tubo in acciaio rivestito di tubo pvc - maniglia in acciaio cromato  
 . Material: plastic-coated steel tube - chromate steel handle

CODICE ITEM	COLORE COLOR	DIAMETRO DIAMETER (ØD)	L1	L2	PZ PCS
1394/A1	GRIGIO - GREY	14	1500	150	10
1394/X	BIANCO - WHITE	14	1500	150	10
1394/M	MARRONE - BROWN	14	1500	150	10
1394/N	NERO - BLACK	14	1500	150	10
1394/A1.18	GRIGIO - GREY	14	1800	150	10
1394/X.18	BIANCO - WHITE	14	1800	150	10
1394/M.18	MARRONE - BROWN	14	1800	150	10
1394/N.18	NERO - BLACK	14	1800	150	10
1394/A1.22	GRIGIO - GREY	14	2200	150	10
1394/X.22	BIANCO - WHITE	14	2200	150	10
1394/M.22	MARRONE - BROWN	14	2200	150	10
1394/N.22	NERO - BLACK	14	2200	150	10

# ASTA CON MANIGLIA SNODATA ALLUMINIO

## ALUMINIUM HANDCRANK WITH JOINTED HANDLE

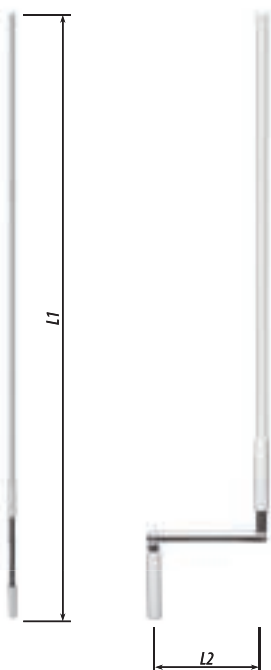
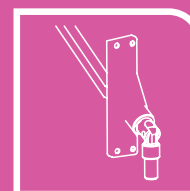

. Materiale: tubo in alluminio verniciato - maniglia in alluminio  
 . Material: painted aluminium tube - aluminium handle

CODICE ITEM	COLORE COLOR	DIAMETRO DIAMETER (ØD)	L1	L2	PZ PCS
1394/B	BIANCO - WHITE	14	1500	150	10
1394/B.18ALU	BIANCO - WHITE	14	1800	150	10
1394/B.22ALU	BIANCO - WHITE	14	2200	150	10

# ASTA INVISIBILE CON MANIGLIA SNODATA

## INVISIBLE HANDCRANK WITH JOINTED HANDLE

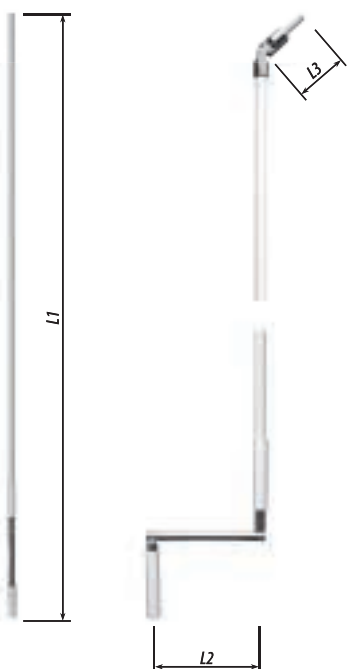

. Materiale: tubo in acciaio rivestito di tubo pvc - maniglia in acciaio cromato  
 . Material: plastic-coated steel tube - chromate steel handle

CODICE ITEM	COLORE COLOR	DIAMETRO DIAMETER (ØD)	L1	L2	L3	SEZIONE SECTION	PZ PCS
1394/G.150	GRIGIO - GREY	14	1500	150	70	QUADRO 8 - SQUARE 8	10
1394/B.150	BIANCO - WHITE	14	1500	150	70	QUADRO 8 - SQUARE 8	10
1394/N.150	NERO - BLACK	14	1500	150	70	QUADRO 8 - SQUARE 8	10

## ASTA PER TENDA DA SOLE

### AWNING'S HANDCRANK

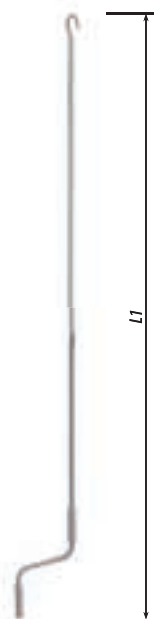
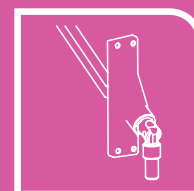

CODICE ITEM	COLORE COLOR	DIAMETRO DIAMETER (ØD)	L1	PZ PCS
1394/W150G	GRIGIO - GREY	14	1500	10
1394/W150B	BIANCO - WHITE	14	1500	10
1394/W180G	GRIGIO - GREY	14	1800	10
1394/W180B	BIANCO - WHITE	14	1800	10
1394/W200G	GRIGIO - GREY	14	2200	10
1394/W200B	BIANCO - WHITE	14	2200	10

## ASTA PER ARGANELLO OSCILLANTE HANDCRANK FOR OSCILLATOR HANDLE WINCH

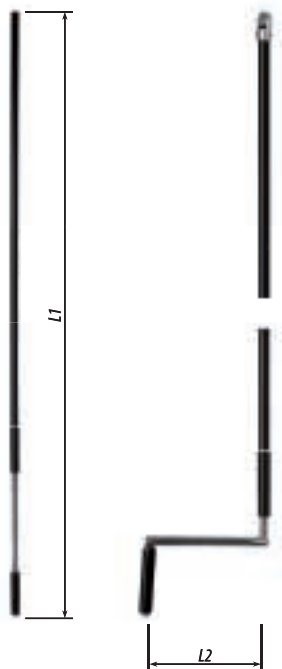

CODICE ITEM	COLORE COLOR	DIAMETRO DIAMETER (ØD)	L1	L2	SEZIONE SECTION	PZ PCS
1394/N.140BC	NERO - BLACK	14	1400	175	QUADRO 8 - SQUARE 8	10
1394/N.180BC	NERO - BLACK	14	1800	175	QUADRO 8 - SQUARE 8	10

## FERMASTA HANDLE STOPPER

. Materiale: nylon - Material: nylon

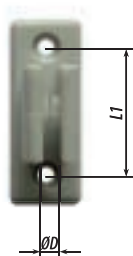

CODICE ITEM	COLORE COLOR	DIAMETRO DIAMETER (ØD)	L1	PZ PCS
1392	GRIGIO - GREY	14	34	200
1392/R	BIANCO - WHITE	14	34	200
1392/T	MARRONE - BROWN	14	34	200
1392/S	NERO - BLACK	14	34	200