

14 TELAI A SPORGERE PROJECTIONS

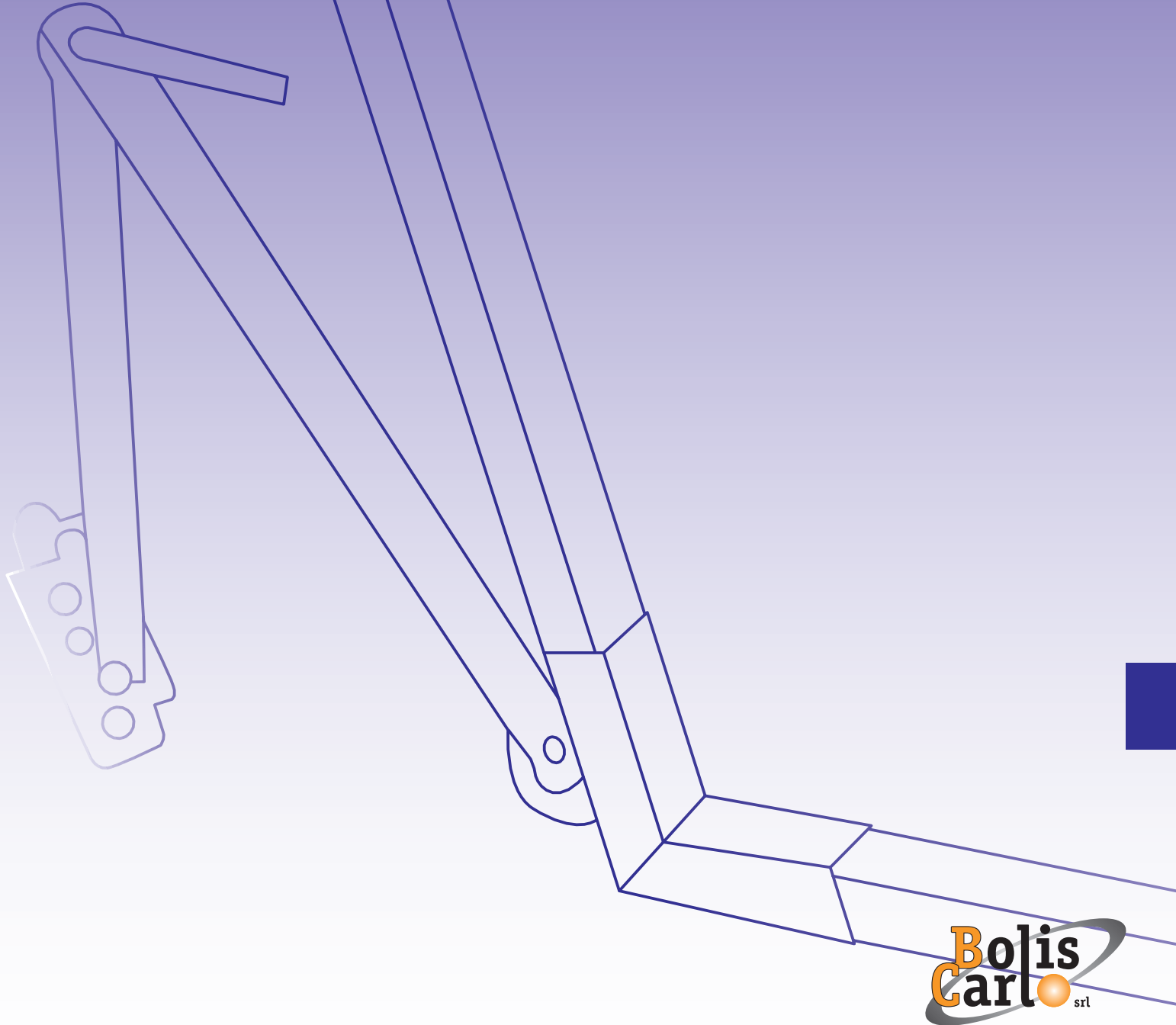

SCHEMA DI MONTAGGIO TELAI A SPORGERE LEVA LATERALE FERRO ZINCATO, INOX E ALLUMINIO

CIRCUIT DIAGRAM OF THE PROJECTIONS WITH LATERAL LEVER
GALVANISED STEEL, INOX AND ALUMINIUM

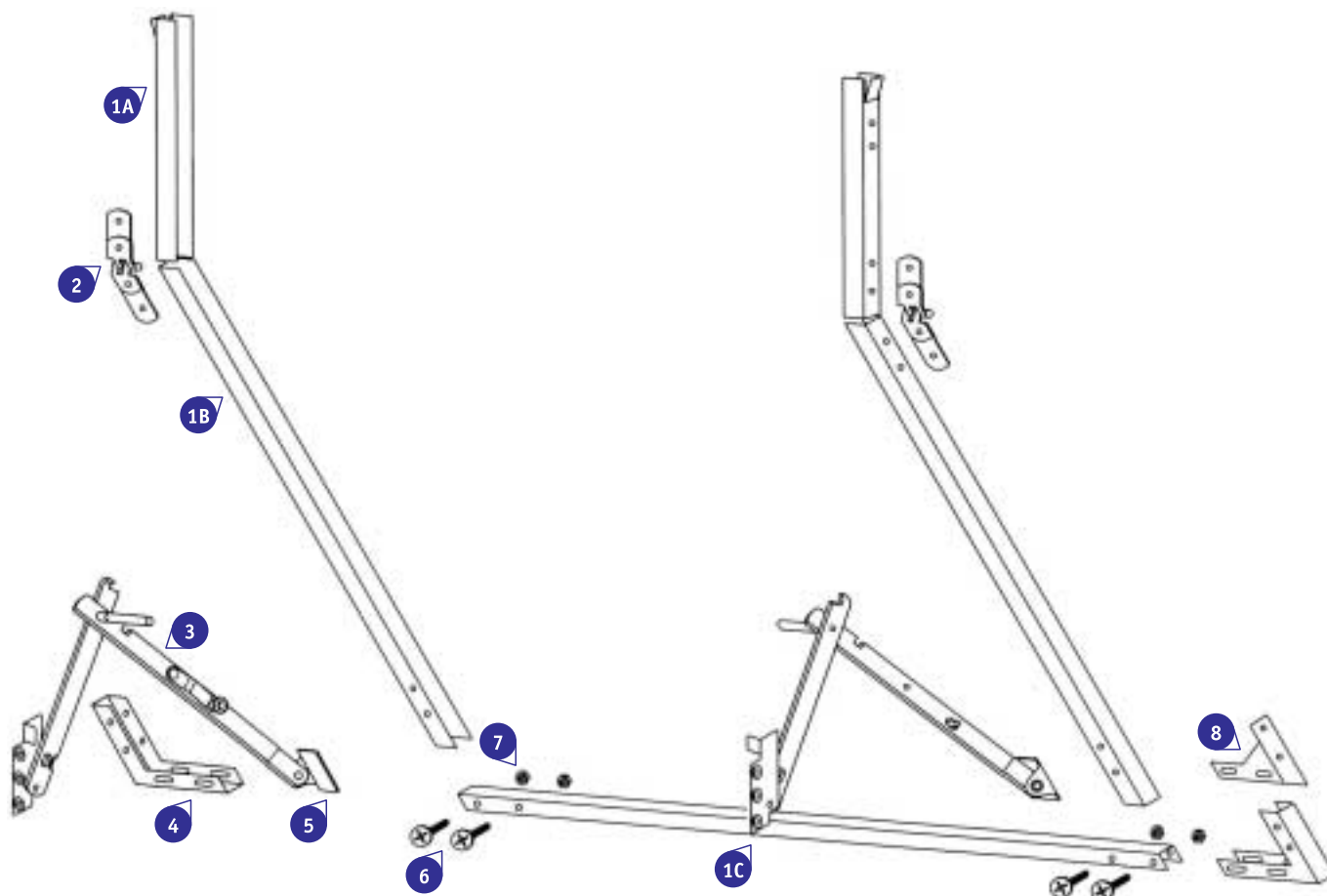
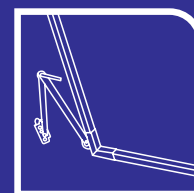

- | | | | |
|----|--|---|---|
| 1A | GUIDA PARTE FISSA
SLIDING PROFILES FIXED PART | 4 | ANGOLO DI RINFORZO A U
U-REINFORCING BRACKET |
| 1B | GUIDA PARTE MOBILE
SLIDING PROFILES MOBILE PART | 5 | ANGOLO DI ANCORAGGIO
ANCHORAGE BRACKET |
| 1C | FERRO A U
U-PROFILES | 6 | VITI
SCREWS |
| 2 | CERNIERA
FASTENER | 7 | DADI
NUTS |
| 3 | BRACCIO PER LEVA LATERALE
ARM FOR LATERAL LEVER | 8 | ANGOLO DI RINFORZO
REINFORCING BRACKET |

SCHEMA DI MONTAGGIO TELAI A SPORGERE LEVA CENTRALE FERRO ZINCATO, INOX E ALLUMINIO

CIRCUIT DIAGRAM OF THE PROJECTIONS WITH CENTRAL LEVER
GALVANISED STEEL, INOX AND ALUMINIUM

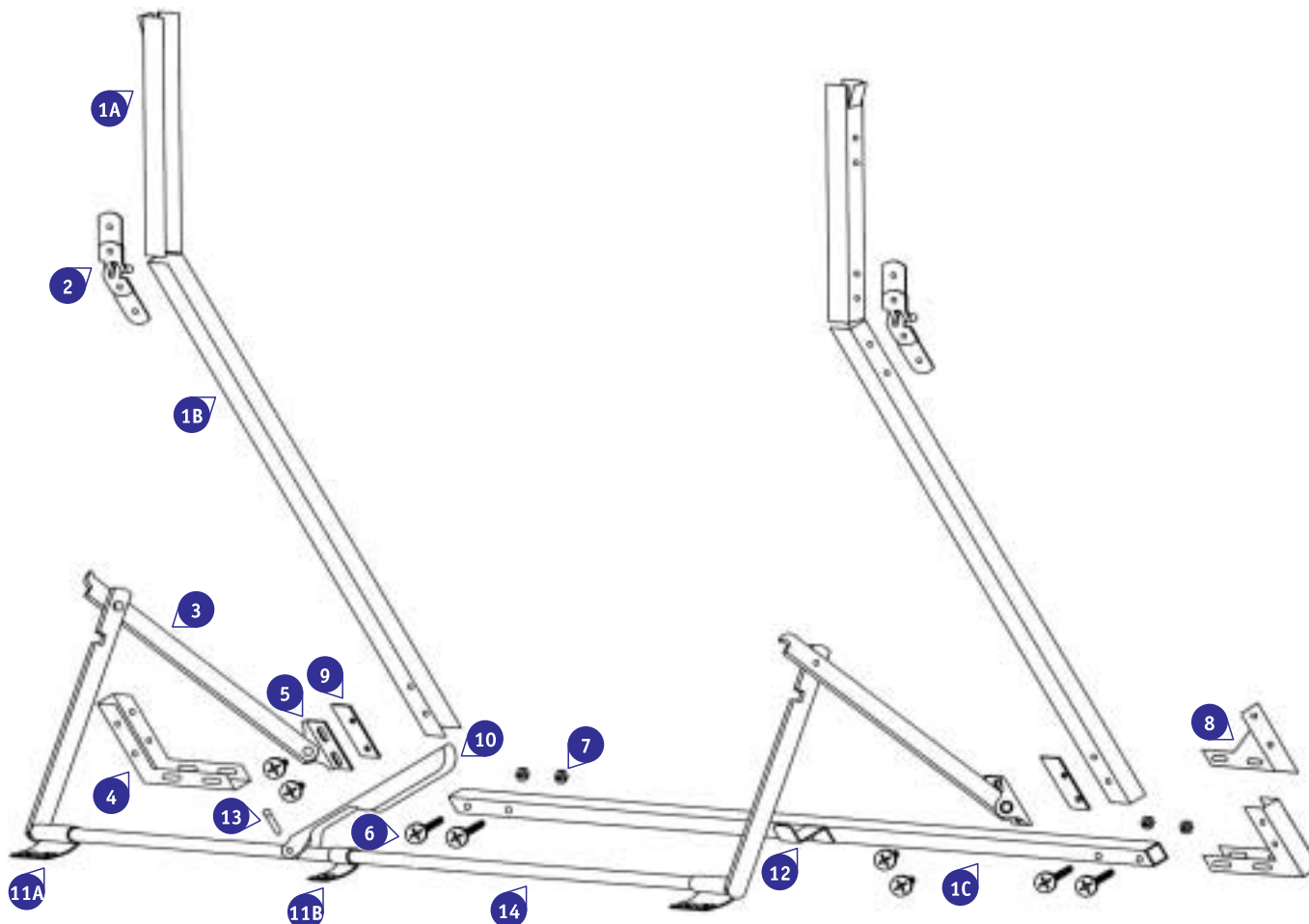
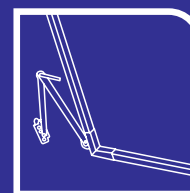

- 1A GUIDA PARTE FISSA
SLIDING PROFILES FIXED PART
- 1B GUIDA PARTE MOBILE
SLIDING PROFILES MOBILE PART
- 1C FERRO A U
U-PROFILES
- 2 CERNIERA
FASTENER
- 3 BRACCIO PER LEVA LATERALE
ARM FOR LATERAL LEVER
- 4 ANGOLO DI RINFORZO A U
U-REINFORCING BRACKET
- 5 ANGOLO DI ANCORAGGIO
ANCHORAGE BRACKET
- 6 VITI
SCREWS
- 7 DADI
NUTS

- 8 ANGOLO DI RINFORZO
REINFORCING BRACKET
- 9 PIASTRINA FILETTATA
THREASES SLAB
- 10 MANIGLIA CENTRALE
CENTRAL HANDLE
- 11A OCCHIOLO CON 2 FORI
EYE WITH 2 HOLES
- 11B OCCHIOLO CON 1 FORO
EYE WITH 1 HOLE
- 12 LINGUETTA
TANG
- 13 RIBATTINO
RIVET
- 14 TONDINO
ROUND BAR

FIANCATE PER TELAI A SPORGERE LEVA LATERALE A SCATOLETTA

SIDE FOR PROJECTIONS LATERAL LEVER SMALL TIN

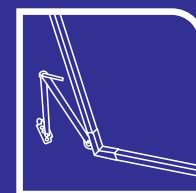

. Materiale: ferro zincato - *Material: galvanised steel*

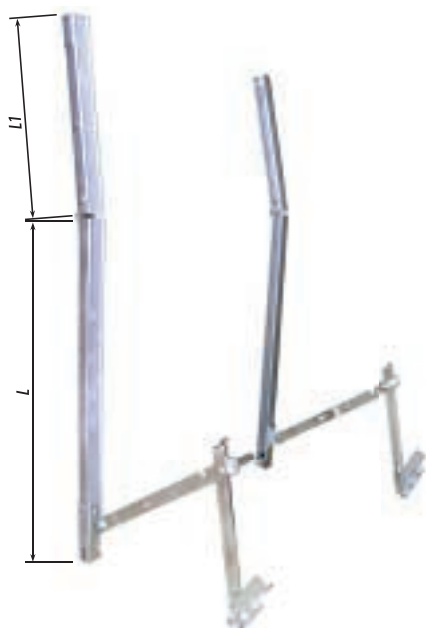

CODICE ITEM	LUNGHEZZA LENGTH (L)	LUNGHEZZA LENGTH (L1)	NOTE NOTES	PZ PCS
1395/B150	150	30	TIPO NORMALE - <i>NORMAL TYPE</i>	5
1395/B160	160	30	TIPO NORMALE - <i>NORMAL TYPE</i>	5
1395/B170	170	30	TIPO NORMALE - <i>NORMAL TYPE</i>	5
1395/B180	180	30	TIPO NORMALE - <i>NORMAL TYPE</i>	5
1395/B190	190	30	TIPO NORMALE - <i>NORMAL TYPE</i>	5
1395/R150	150	30	TIPO ROMA - <i>ROMA TYPE</i>	5
1395/R160	160	30	TIPO ROMA - <i>ROMA TYPE</i>	5
1395/R170	170	30	TIPO ROMA - <i>ROMA TYPE</i>	5
1395/R180	180	30	TIPO ROMA - <i>ROMA TYPE</i>	5
1395/R190	190	30	TIPO ROMA - <i>ROMA TYPE</i>	5

TELAI A SPORGERE LEVA LATERALE FERRO ZINCATO

GALVANISED STEEL PROJECTIONS WITH LATERAL LEVER

. Materiale: ferro zincato - *Material: galvanised steel*



CODICE ITEM	PZ PCS
1395/B	1

TELAI A SPORGERE LEVA LATERALE ALLUMINIO

ALUMINIUM PROJECTIONS WITH LATERAL LEVER

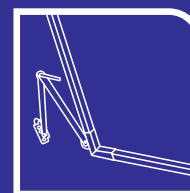

. Materiale: alluminio anodizzato - *Material: anodised aluminium*

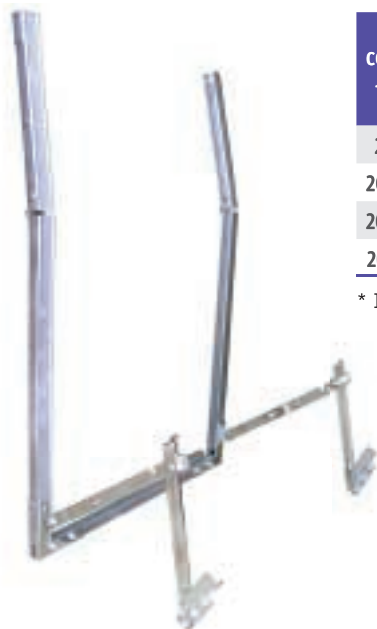

CODICE ITEM	NOTE NOTES	PZ PCS	
2000	INTERAMENTE IN ALLUMINIO - <i>ONLY ALUMINIUM</i>	ARGENTO - <i>SILVER</i>	1
2000/A	INTERAMENTE IN ALLUMINIO - <i>ONLY ALUMINIUM</i>	BRONZO - <i>BRONZE</i>	1
2000/B	INTERAMENTE IN ALLUMINIO - <i>ONLY ALUMINIUM</i>	NERO - <i>BLACK</i>	1
2000.V	INTERAMENTE IN ALLUMINIO - <i>ONLY ALUMINIUM</i>	VERNICIATO - <i>PAINTED*</i>	1

* I braccetti non vengono verniciati - *Arm are not painted*

TELAI A SPORGERE LEVA LATERALE ALLUMINIO CON BRACCI IN FERRO

ALUMINIUM PROJECTIONS WITH LATERAL LEVER WITH ARM GALVANISED STEEL

. Materiale: alluminio anodizzato - *Material: anodised aluminium*



CODICE ITEM	NOTE NOTES	PZ PCS	
2002	CON BRACCIO FERRO ARGENTO - <i>WITH ARM SILVER GALVANISED STEEL</i>	1	
2002/A	CON BRACCIO FERRO BRONZO - <i>WITH ARM BRONZED GALVANISED STEEL</i>	1	
2002/V	CON BRACCI FERRO ZINCATO - <i>WITH GALVANISED STEEL ARM</i>	TUTTO VERNICIATO - <i>ALL PAINTED</i>	1

TELAI A SPORGERE LEVA CENTRALE FERRO ZINCATO

GALVANISED STEEL PROJECTIONS WITH CENTRAL LEVER

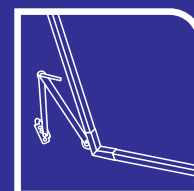

. Materiale: ferro zincato - *Material: galvanised steel*

CODICE ITEM	NOTE NOTES	PZ PCS
1395/LCA	TIPO NORMALE - <i>NORMAL TYPE</i>	1
1395/LCRM	TIPO ROMA - <i>ROMA TYPE</i>	1

TELAI A SPORGERE LEVA CENTRALE ALLUMINIO

ALUMINIUM PROJECTIONS WITH CENTRAL LEVER



. Materiale: alluminio anodizzato - *Material: anodised aluminium*

CODICE ITEM	NOTE NOTES	PZ PCS	
2001	INTERAMENTE IN ALLUMINIO - <i>ONLY ALUMINIUM</i>	ARGENTO - <i>SILVER</i>	1
2001/A	INTERAMENTE IN ALLUMINIO - <i>ONLY ALUMINIUM</i>	BRONZO - <i>BRONZE</i>	1
2001/B	INTERAMENTE IN ALLUMINIO - <i>ONLY ALUMINIUM</i>	NERO - <i>BLACK</i>	1
2001.V	INTERAMENTE IN ALLUMINIO - <i>ONLY ALUMINIUM</i>	VERNICIATO - <i>PAINTED</i>	1

* I braccetti non vengono verniciati - *Arm are not painted*

TELAI A SPORGERE LEVA CENTRALE ALLUMINIO CON BRACCI IN FERRO ZINCATO

GALVANISED STEEL PROJECTIONS WITH CENTRAL LEVER



. Materiale: alluminio anodizzato - *Material: anodised aluminium*

CODICE ITEM	NOTE NOTES	PZ PCS	
2003	CON BRACCIO FERRO ARGENTO - <i>WITH ARM SILVER GALVANISED STEEL</i>	1	
2003/A	CON BRACCIO FERRO BRONZO - <i>WITH ARM BRONZED GALVANISED STEEL</i>	1	
2003/V	CON BRACCI FERRO ZINCATO - <i>WITH GALVANISED STEEL ARM</i>	TUTTO VERNICIATO - <i>ALL PAINTED</i>	1

BRACCIO PER LEVA LATERALE

ARM FOR LATERAL LEVER

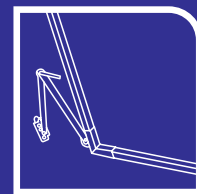

. Materiale: ferro zincato - *Material: galvanised steel*

CODICE ITEM	LUNGHEZZA LENGTH (L)	LUNGHEZZA LENGTH (L1)	NOTE NOTES	PZ PCS
1395/A	231	342	TIPO NORMALE - <i>NORMAL TYPE</i>	20
1395/AC	197	278	TIPO NORMALE - <i>NORMAL TYPE</i>	20

. Materiale: acciaio inox - *Material: stainless steel*

CODICE ITEM	LUNGHEZZA LENGTH (L)	LUNGHEZZA LENGTH (L1)	NOTE NOTES	PZ PCS
1395	231	342	TIPO NORMALE - <i>NORMAL TYPE</i>	20

. Materiale: alluminio - *Material: aluminium*

CODICE ITEM	LUNGHEZZA LENGTH (L)	LUNGHEZZA LENGTH (L1)	NOTE NOTES	NOTE NOTES	PZ PCS
1395/AA	231	342	TIPO NORMALE - <i>NORMAL TYPE</i>	ARGENTO - <i>SILVER</i>	20
1395/AB	231	342	TIPO NORMALE - <i>NORMAL TYPE</i>	BRONZO - <i>BRONZE</i>	20
1395/AN	231	342	TIPO NORMALE - <i>NORMAL TYPE</i>	NERO - <i>BLACK</i>	20

. Materiale: ferro zincato - *Material: galvanised steel*

CODICE ITEM	LUNGHEZZA LENGTH (L)	LUNGHEZZA LENGTH (L1)	NOTE NOTES	PZ PCS
1395/LR	231	342	TIPO ROMA - <i>ROMA TYPE</i>	20
1395/CR	197	278	TIPO ROMA - <i>ROMA TYPE</i>	20

BRACCIO PER LEVA CENTRALE

ARM FOR CENTRAL LEVER

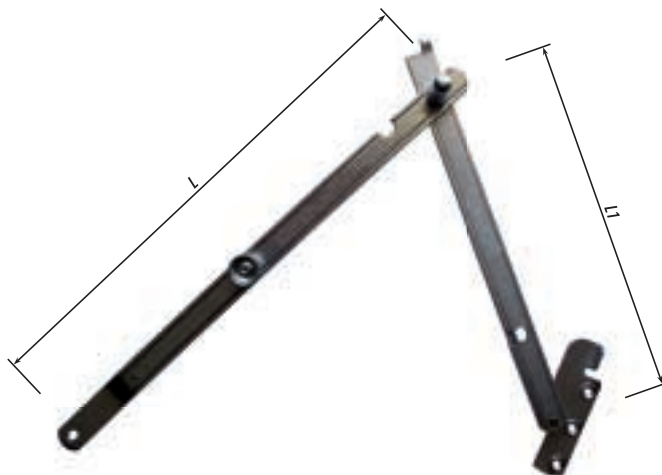
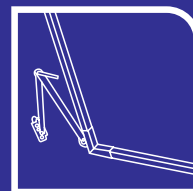

. Materiale: ferro zincato - *Material: galvanised steel*

CODICE ITEM	LUNGHEZZA LENGTH (L)	LUNGHEZZA LENGTH (L1)	NOTE NOTES	PZ PCS
1395/LC	313	263	TIPO NORMALE - NORMAL TYPE	20
1395/LCC	263	213	TIPO NORMALE - NORMAL TYPE	20

. Materiale: acciaio inox - *Material: stainless steel*

CODICE ITEM	LUNGHEZZA LENGTH (L)	LUNGHEZZA LENGTH (L1)	NOTE NOTES	PZ PCS
1395/LC1	313	263	TIPO NORMALE - NORMAL TYPE	20

. Materiale: alluminio - *Material: aluminium*

CODICE ITEM	LUNGHEZZA LENGTH (L)	LUNGHEZZA LENGTH (L1)	NOTE NOTES	NOTE NOTES	PZ PCS
1395/LCAR	313	263	TIPO NORMALE - NORMAL TYPE	ARGENTO - SILVER	20
1395/LCB	313	263	TIPO NORMALE - NORMAL TYPE	BRONZO - BRONZE	20
1395/LCN	313	263	TIPO NORMALE - NORMAL TYPE	NERO - BLACK	20

. Materiale: ferro zincato - *Material: galvanised steel*

CODICE ITEM	LUNGHEZZA LENGTH (L)	LUNGHEZZA LENGTH (L1)	NOTE NOTES	PZ PCS
1395/LCR	313	263	TIPO ROMA - ROMA TYPE	20
1395/LCRC	263	313	TIPO ROMA - ROMA TYPE	20

. Materiale: alluminio - *Material: aluminium*

CODICE ITEM	LUNGHEZZA LENGTH (L)	LUNGHEZZA LENGTH (L1)	NOTE NOTES	NOTE NOTES	PZ PCS
1395/LCRA	313	263	TIPO ROMA - ROMA TYPE	ARGENTO - SILVER	20
1395/LCRB	313	263	TIPO ROMA - ROMA TYPE	BRONZO - BRONZE	20
1395/LCRN	313	263	TIPO ROMA - ROMA TYPE	NERO - BLACK	20

ANGOLO DI RINFORZO

REINFORCING BRACKET

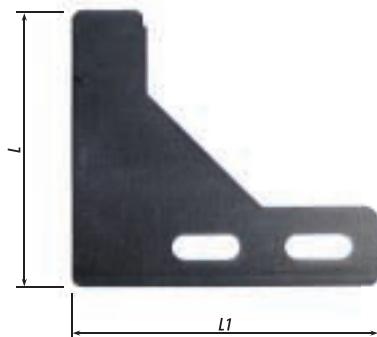
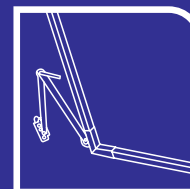

CODICE ITEM	LUNGHEZZA LENGTH (L)	LUNGHEZZA LENGTH (L1)	NOTE NOTES	PZ PCS
1399	80	85	FERRO ZINCATO - GALVANISED STEEL	100
1399/B	80	85	ACCIAIO INOX - STAINLESS STEEL	100
1399/BA	80	85	ALLUMINIO GREZZO - ALUMINIUM UNPROCESSED	100

ANGOLO DI RACCORDO

ANGLE



CODICE ITEM	NOTE NOTES	PZ PCS
1399/F	FERRO ZINCATO - GALVANISED STEEL	100

CERNIERA

HINGE



CODICE ITEM	LUNGHEZZA LENGTH (L)	LUNGHEZZA LENGTH (L1)	NOTE NOTES	PZ PCS
1396/A	80	22	FERRO ZINCATO - GALVANISED STEEL	100
1396/A25	80	25	FERRO ZINCATO - GALVANISED STEEL	100
1396/I22	80	22	ACCIAIO INOX - STAINLESS STEEL	100
1396	80	25	ACCIAIO INOX - STAINLESS STEEL	100

MANIGLIA CENTRALE

HANDLE FOR CENTRALHAND LEVER



CODICE ITEM	LUNGHEZZA LENGTH (L)	NOTE NOTES	PZ PCS
1397	215	FERRO ZINCATO - GALVANISED STEEL	20
1397/A	215	ACCIAIO INOX - STAINLESS STEEL	20

ANGOLO DI RINFORZO A U

U REINFORCING BRACKET

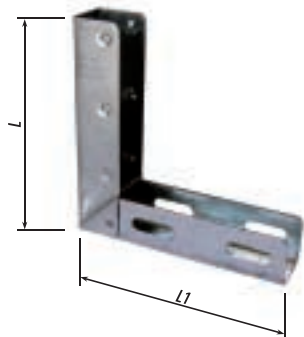
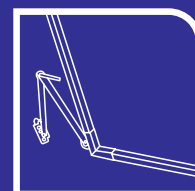

CODICE ITEM	LUNGHEZZA LENGTH (L)	LUNGHEZZA LENGTH (L1)	NOTE NOTES	PZ PCS
1399/A	100	100	FERRO ZINCATO - GALVANISED STEEL	200

OCCHIOLO CON 2 FORI

EYELET WITH 2 HOLES



CODICE ITEM	LUNGHEZZA LENGTH (L)	NOTE NOTES	PZ PCS
1398/A	40	FERRO ZINCATO - GALVANISED STEEL	100
1398	40	ACCIAIO INOX - STAINLESS STEEL	100

PIASTRINA FILETTATA

THREADED SLAB



CODICE ITEM	LUNGHEZZA LENGTH (L)	LUNGHEZZA LENGTH (L1)	NOTE NOTES	PZ PCS
1399/J	67	20	FERRO ZINCATO - GALVANISED STEEL	100
1399/E	67	20	ACCIAIO INOX - STAINLESS STEEL	100

TUBOLARE IN VERGHE PER TELAI

TUBULAR FOR PROJECTIONS IN BARS

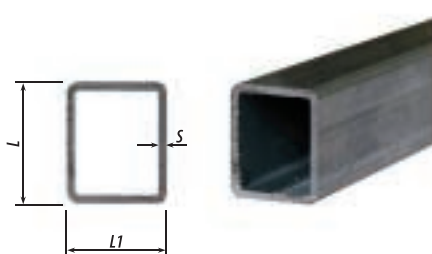

CODICE ITEM	LUNGHEZZA LENGTH (L)	LUNGHEZZA LENGTH (L1)	LUNGHEZZA LENGTH (L2)	NOTE NOTES	PZ PCS
1397/B	20	18	1,5	FERRO ZINCATO - GALVANISED STEEL	20