

Easy Start Guide

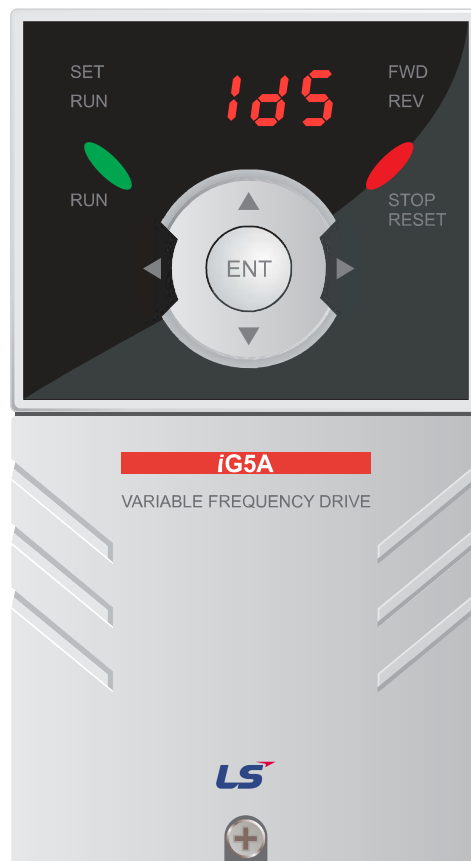

LS Industrial Systems
Starvert SV-iG5A Frequency Inverter
available from S.E.I. Service Elettronica Industriale

This guide is intended to compliment the user manual provided by the manufacturer. It is provided as a basic introduction to the product for Inverter Drive Supermarket customers. It should not be used as a replacement for the manual issued by the manufacturer.



This product is not a safety device. All safety considerations including but not limited to Emergency Stop provision should be assessed separately and are outside the scope of this guide.

S.E.I. Service Elettronica Industriale

Easy Start Guide

LS Industrial Systems SV-iG5A



1. Power and Motor Connections (Three Phase)



Before commencing, confirm that the iG5A and all cables are completely isolated from the power supply, have been isolated for at least 5 minutes and that the motor is not turning.

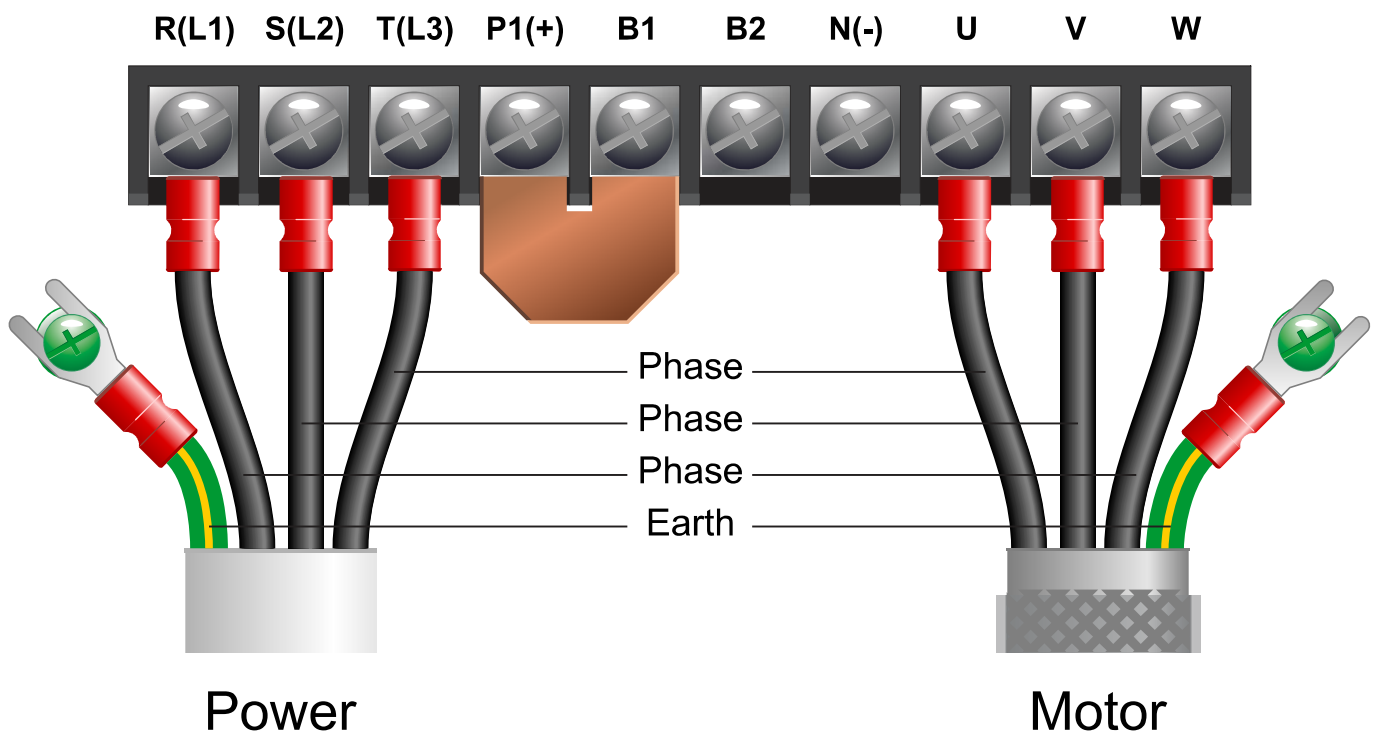

Notes:

The illustration above is based on the 11kW - 22kW size. The terminal layout for the smaller sizes (0.37kW - 7.5kW) is slightly different.

The order of the three motor phases determines the direction the motor turns.

The order of the three power phases is unimportant.

The smaller green earth terminals are not part of the main terminal block.

Important:

Do not connect any of the Power or Motor cables to the terminals marked P1(+), B1, B2 or N(-).

The terminal marked "N" does NOT mean Neutral.

Use screened SY cable between the Inverter and Motor to minimise electromagnetic interference and ensure the screen is earthed at the motor end.

2. Motor Connections - Star and Delta

Dual voltage induction motors typically include terminal boxes with six points. The points can be connected together with links in one of two ways to suit one of the two rated voltages.

The two ways of connecting the links are shown below. These are known as “Star” (the higher voltage) or “Delta” (the lower voltage).

The selection of Star or Delta is not optional and must match the supply voltage.

Dual voltage motor nameplates include symbols to represent voltage and full load current in each configuration.

Delta is represented by a triangle and star by a Y (Wye).

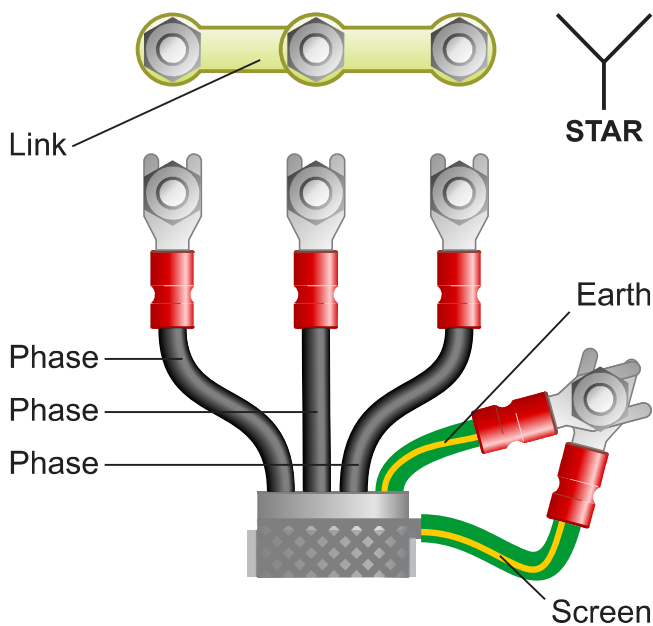

2.1 Motor connected in STAR (or Wye):

Star connection is suitable for:-

400V supply to 230/400V dual-voltage motor.
660V supply to 400/660V dual-voltage motor.

For safety purposes, Star (shown opposite) is the default configuration for new motors and is sometimes known as “two at one side”.

Only two links are required for Star. Double-up the links if changing from Delta to allow the motor to be changed to back in future.

The order of the three phases determines the direction the motor turns.

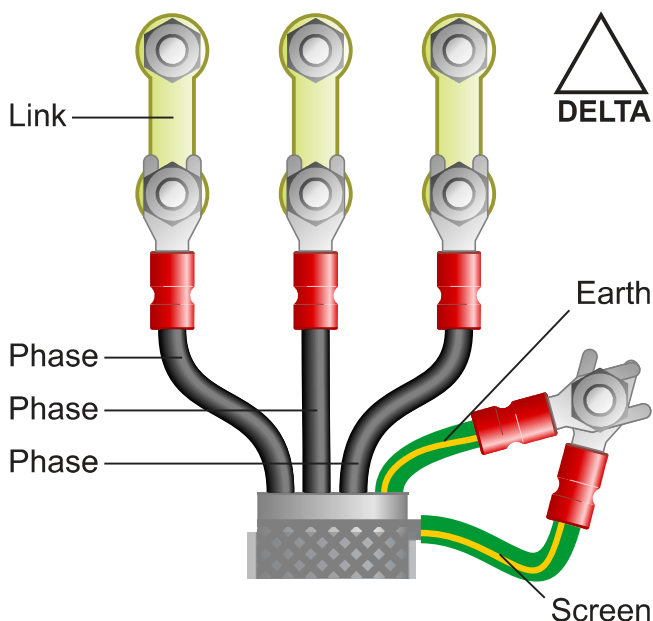

2.2 Motor connected in DELTA:

Delta connection is suitable for:-

230V supply to 230/400V dual-voltage motor.
400V supply to 400/660V dual-voltage motor.

The link configuration is shown in the illustration opposite and is sometimes referred to a “three-a-breast”.

The order of the three phases determines the direction the motor turns.

Note that the cable screen and earth are connected together at the earth terminal.

3. Parameters - overview

The iG5A contains a number of settings which can be changed to tailor it for use in a wide range of applications. These settings are known as parameters.

Parameters are typically referred to by code or number (eg. H21 = Max Output Frequency) with a description available in the manual.

The parameters contain critical information essential to the correct operation of the iG5A. Therefore, they should at least be checked by the user before it is operated for the first time.

The parameters listed in section 4 are intended to provide a starting point to allow for basic operation of the iG5A Inverter.

4. Parameters to set before use

Set the following parameters to allow the iG5A to run in standard mode with Run, Stop and Speed Control from the integral keypad.

If any of the parameters have been changed previously, follow the procedure in section 12 to reset the iG5A to Factory Defaults.

See section 7 for an explanation of Parameter Groups and to learn how to set a parameter value.

4.1 Parameters in the Drive Group

Press left/right to find 0.00 (or selected frequency) then up/down to find parameter

Parameter	Description	How to set
drv	Run/Stop Command Source	Set to 0 for Run/Stop buttons on the iG5A.
Frq	Speed Command Source	Set to 1 to use internal frequency parameter (can be changed whilst the motor is running).

4.2 Parameters in Function Group 1 - "F"

Press left/right to find F0 then up/down to find parameter number

Parameter	Description	How to set
F21	Max Output Frequency in Hz	Default is 60. Change to 50 for 50Hz motor.
F22	Base Frequency	Default is 60. Change to 50 for 50Hz motor.
F24	Enable Max/Min Frequency	Default is 0 (off). Set to 1 to enable parameters F25 and F26 for future use.
F27	Torque Boost	Default is 0 (off). Set to 1 to improve starting Torque.
F50	Thermal Overload	Default is 0 (off). Set to 1 to enable Thermal Overload Protection.

4.3 Parameters in Function Group 2 - "H"

Press left/right to find H0 then up/down to find parameter number

Parameter	Description	How to set
H30	Motor Power in kW	Set to match motor nameplate - eg. 0.75 for 0.75kW, 1.5 for 1.5kW etc.
H31	Number of Motor Poles	Set to match motor nameplate - eg. 2700-3000RPM = 2, 1350-1500RPM = 4 etc.
H32	Motor Slip in Hz	Calculate: (Motor Frequency - ((Motor RPM x Poles) / 120))
H33	Motor Full Load Current in Amps	Set to match motor nameplate - eg. 4.7
H34	Motor No-Load Current in Amps	See section 6 for details of how to correctly set this value.

5. How to set “Motor no-load current” - H34

Skip this section if using the iG5A in a Fan or Pump application.

Motor no load current is an important parameter to set to get the best possible motor performance.

Correctly set, it allows the Inverter to maintain the precise output current to suit the motor and significantly improves torque at lower speeds.

The procedure involves running the motor off-load at it's rated speed and making a note of output current. This value is then set in parameter H34.

Once set, this can be confirmed by running the motor off-load at 50Hz and 5Hz and noting that the output current is the same in both cases.

5.1 How to determine “Motor no-load current” by operating the iG5A.



5.1.1 Set the frequency to 50Hz and start the motor.

Motor no-load current can only be determined with the motor running off-load. Decouple the motor from the machine before beginning!

Follow the instructions described in section 7 “How to operate the Inverter” to set the output frequency to 50Hz and start the motor.

Once the Inverter has reached 50.00Hz proceed to the step below.



5.1.2 Use the navigation pad to locate the “CUR” parameter.

Whilst the motor is running, press the down arrow on the navigation pad until “CUR” is displayed (as shown opposite). “CUR” is a read-only parameter which displays output current in Amps.

Press "ENT" to select “Cur”. The output current will be displayed.

Make a note of this value. It is “Motor no-load current” in Amps and must be set in parameter H34.

Press the red “Stop/Reset” button to stop the motor.

6. How to set a Parameter value



6.1 Use the left and right arrows on the navigation pad to move between parameter groups.

From the initial screen (shown opposite), press the right arrow on the navigation pad to move between each of the four parameter groups. Select "H0".

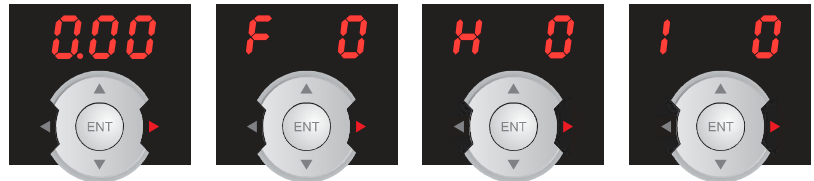

Drive
Group

Function
Group 1 "F"

Function
Group 2 "H"

I/O
Group

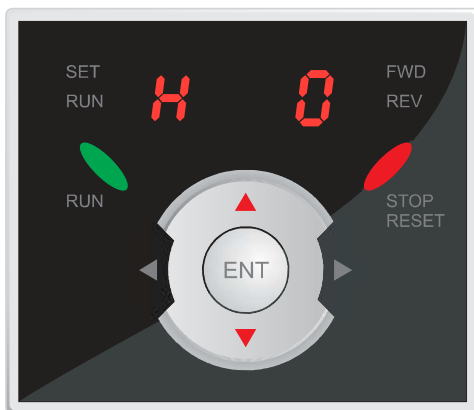

6.2 Use the up and down arrows on the navigation pad to move between parameters within the selected parameter group.



In this example, we will set Parameter H33 (Function Group 2 "H", Parameter number 33) which is motor rated current.



Press the up arrow on the navigation pad repeatedly to move from H0 to H1, H2, H3 etc. until you reach H33.

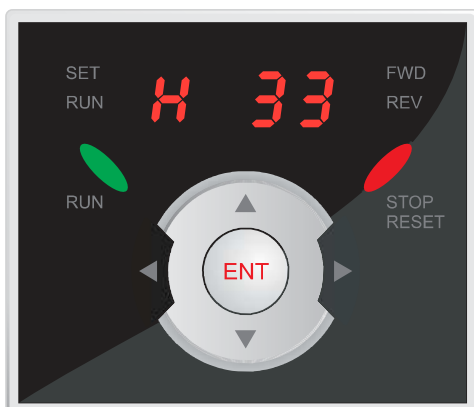

6.3 Press "ENT" to edit a parameter.

Once the desired parameter is shown on the display, in this case H33, press "ENT" to select it.

Easy Start Guide

LS Industrial Systems SV-iG5A



6.4 Use the left and right arrows on the navigation pad to move between digits. Use the up and down arrows to increase or decrease the digit value.

In this example, the motor nameplate states 4.7A at 230V so we will change the default value from 5.0 to 4.7.



Press up to change 0 to 7



Press left to change digit



Press down to change 5 to 4



6.5 Press "ENT" to save changes. Press "ENT" again to confirm.

Once the value of H33 has been changed to 4.7 press "ENT" to save changes.

The display will then flash indicating that the change needs to be confirmed.

Press "ENT" again to confirm the change or wait to cancel the change and return to the edit screen in the previous step.

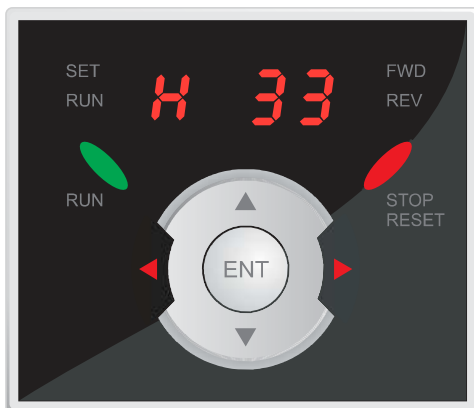

6.6 Parameter value is set.

Now H33 has been successfully set. The screen will return to the parameter list.

Repeat the steps above to set the value of other parameters. See section 5 for recommended settings.

Press the left or right keys on the navigation pad to return to the Drive Group (ie. the group which does not start with F, H or I).

7. How to operate the Inverter

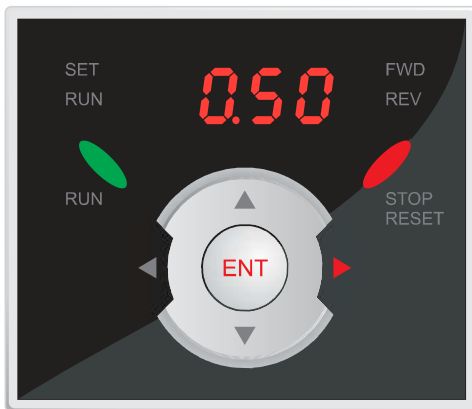

7.1 Set the required speed.

Use the right navigation key to cycle through the F, H and I parameter groups until you reach the “Drive” group - the display will show 0.50 or your selected frequency.

Press “ENT” to edit this value and use the navigation keys to change the value as required (eg. to 50.00). Press “ENT” to save changes.

Note: If the motor is running, changes to the frequency value will take effect immediately (ie. no need to save).

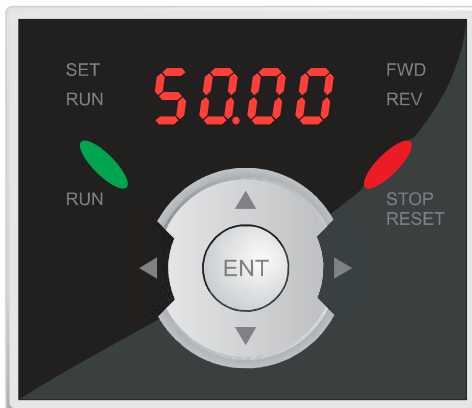

7.2 Press the green “Run” button to start the motor.

The green “Run” button will start the motor. The motor will accelerate to the speed set in step 1 (above) in the time defined by the “ACC” parameter found in the “Drive” parameter group.

Motor speed can be changed whilst the motor is running by modifying the frequency value as described in 8.1 above.

When the motor is running, the “RUN” light will be displayed. The “FWD” or “REV” light will also be displayed depending on the direction of rotation.

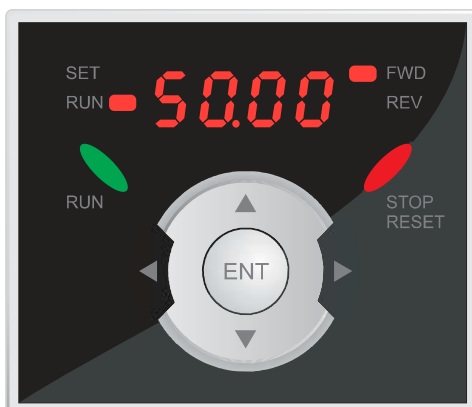

7.3 Press the red “Stop/Rst” button to stop the motor.

The red “Stop/Rst” button will stop the motor.

The time taken (in seconds) to stop the motor is determined by the “dEC” parameter which can be found in the “Drive” parameter group.

8. How to enable Sensorless Vector Mode

The standard operating mode of the iG5A Inverter is VxF. This is the simplest form of operation and controls Volts and Frequency to vary the speed of a standard Induction Motor.

The iG5A can also operate in Sensorless Vector mode. This can improve motor performance without requiring a separate feedback device.

Sensorless Vector mode operates in the same way as VxF but performs a number of calculations to improve low speed torque. This requires an "ID" run during which the Inverter runs the motor for approx. 1 minute at various speeds to gather the necessary data.

Decouple the motor from the machine before starting an ID run.

8.1 Parameters in Function Group 2 - "H"

Press left/right to find H0 then up/down to find parameter number

Parameter	Description	How to set
H40	Control Mode	Default is 0. Change to 3 to enable Sensorless Vector Mode.
H41	Auto-tuning	Default is 0. Ensure motor is off-load before changing to 1 to begin ID run.

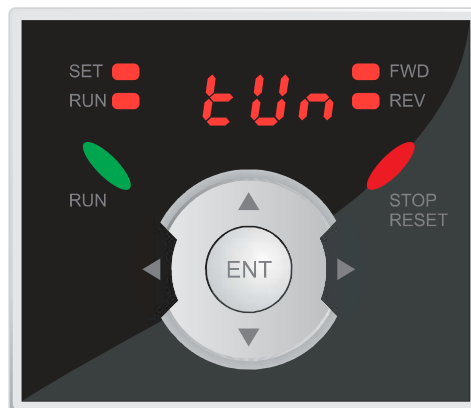

The display will show "tun" whilst the iG5A performs it's ID run.

9. How to connect and configure a Potentiometer for remote speed control

If the iG5A speed control parameter is unsuitable for the application, a remote Potentiometer can be used instead.

This provides the benefit of allowing motor speed to be controlled from a more convenient location such as a cabinet door (if the iG5A is cabinet-mounted) or on the machine itself.

A Potentiometer of **10kOhm** rating should be used.

The number of turns depends on the application but both single turn and ten turn Potentiometers are available from The Inverter Drive Supermarket at InverterDrive.com.

9.1 Parameters to change in the Drive Group

Press left/right to find 0.00 (or selected frequency) then up/down to find parameter

Parameter	Description	How to set
Frq	Speed Command Source	Set to 3 to enable 0-10V via 10kOhm Potentiometer

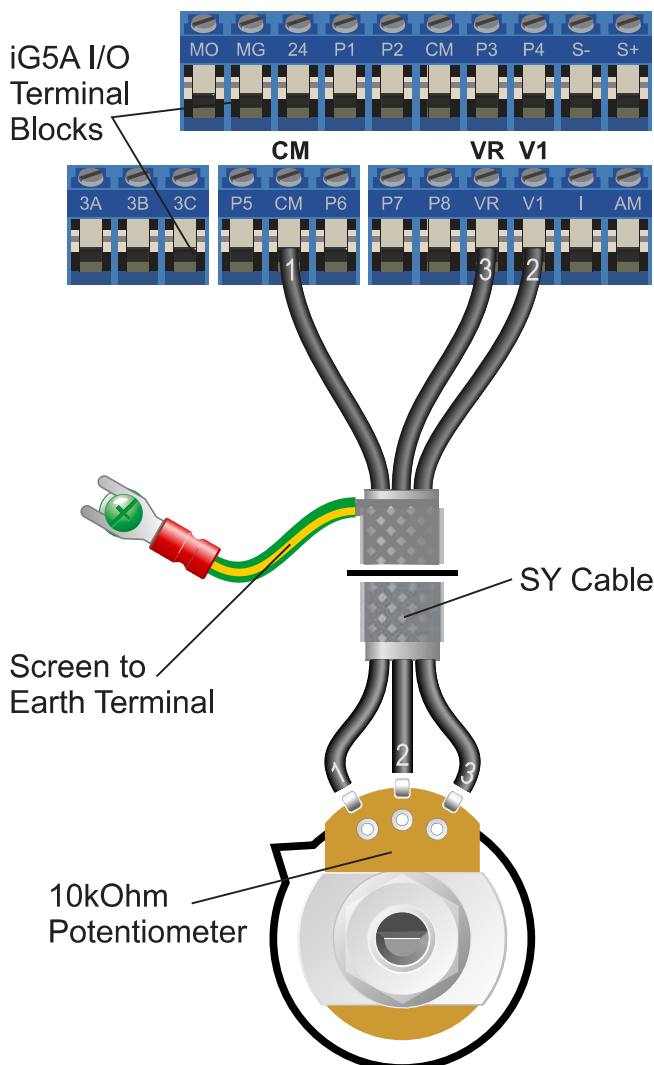

9.2 Connecting the Potentiometer

A wiring diagram is shown in the illustration opposite. The most important connection at the Potentiometer end is the centre terminal or “wiper”.

The wiper will output a variable voltage between 0 and 10 volts and should be connected to the V1 terminal at the Inverter end. It is this voltage which provides the speed signal with 0V being slowest and 10V fastest.

The default output frequency at 0V is 0Hz. To change this, edit Parameter I8.

The default output frequency at 10V is 60Hz. To change this, edit Parameter I10.

If the rotation of the Potentiometer is the opposite to that required (ie. turn anti-clockwise to increase speed instead of clockwise) reverse connections VR and CM.

Use shielded SY cable between Potentiometer and Inverter and ensure that the cable screen is earthed at the green earth terminal on the Inverter.

10. How to connect and configure a Run/Stop switch

The parameters described in Section 5 enable Run/Stop operation via the red and green buttons on the Inverter.

If this is unsuitable for the application, a remote Run/Stop switch can be used instead.

Note that once this procedure is complete, the Run/Stop buttons on the Inverter can no longer be used.

10.1 Parameters to change in the Drive Group

Press left/right to find 0.00 (or selected frequency) then up/down to find parameter

Parameter	Description	How to set
drv	Run/Stop Command Source	Set to 1 for Programmable Input 1 "P1".

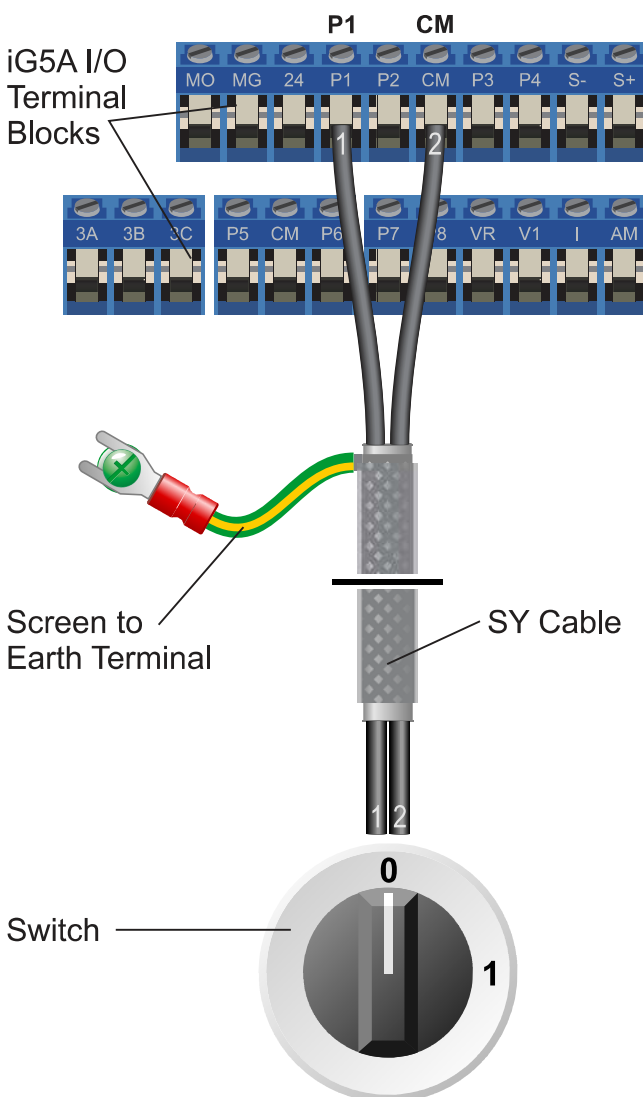

10.2 Connecting the Switch

A wiring diagram is shown in the illustration opposite.

The CM terminal output is 24V DC when the Inverter is connected to a power supply. This is provided as a 24V output only and has no other function.

When the P1 terminal receives 24V (ie. when the circuit with CM is complete), Run is enabled and motor will turn. Conversely, when it receives 0V (ie. when the circuit with CM is broken), Run is disabled and the motor will stop.

This behaviour is known as a **Digital Input**.

Any 24V DC signal connected to P1 will cause the Inverter to run. This can be useful if an external source such as a PLC is controlling the Inverter. If the 24V DC signal is external, a connection to CM is not required.

Use shielded SY cable between the switch and Inverter and ensure that the cable screen is earthed at the green earth terminal on the Inverter.

Note that although 2 core SY cable is shown in the illustration opposite, multi-core SY cable can be used if several digital inputs are to be used.

11. How to connect and configure a Fwd/Rev switch

The parameters described in Section 5 enable Run/Stop operation via the red and green buttons on the Inverter.

Section 11 explains how to enable remote Run/Stop via a switch instead.

This section extends the functionality added in section 11 to allow Forward/Reverse direction to be selected as well as Run/Stop.

11.1 Parameters to change in the Drive Group

Press left/right to find 0.00 (or selected frequency) then up/down to find parameter

Parameter	Description	How to set
drv	Run/Stop Command Source	Set to 2 for Run/Stop via Input 1 "P1" and Fwd/Rev via Input 2 "P2".

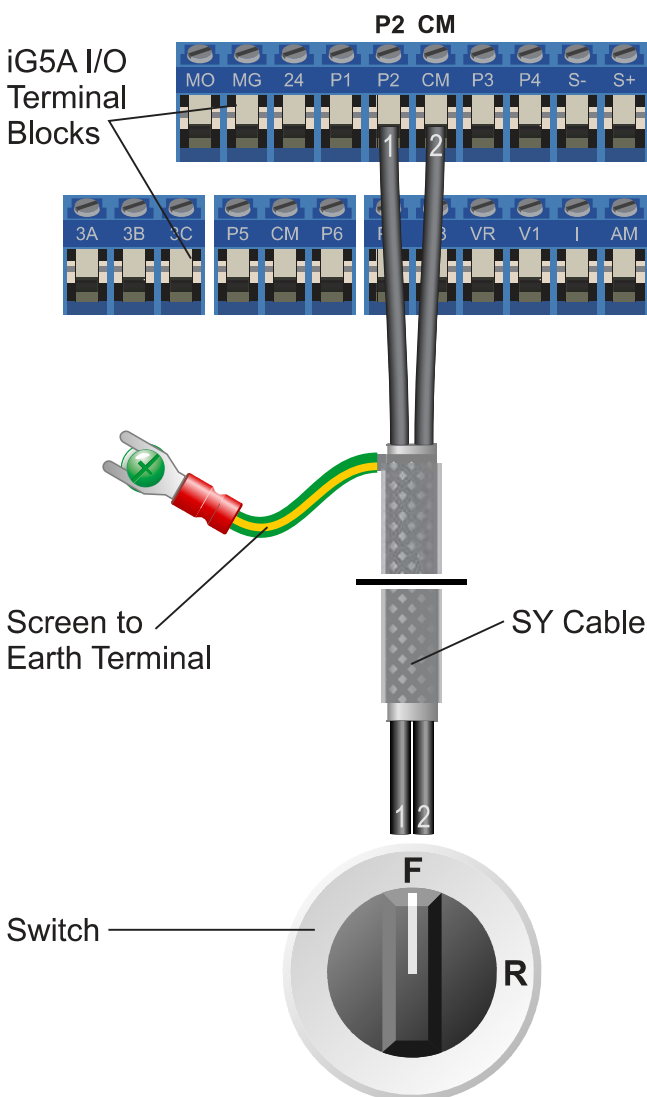

11.2 Connecting the Switch

A wiring diagram is shown in the illustration opposite.

Note that this switch should be used in conjunction with a Run/Stop switch as described in section 10.

When the switch is in position "F" (forward), the circuit between P2 and CM is incomplete and the motor direction is set to forward.

When the switch is in position "R" (reverse), the circuit between P2 and CM is complete and the motor direction is set to reverse.

This behaviour is known as a **Digital Input**.

If the switch is changed from "F" to "R" (or vice versa) whilst the motor is running, the motor will slow to a stop before starting in the opposite direction.

Any 24V DC signal from an external source such as a PLC connected to P2 will set the direction of rotation.

Use shielded SY cable between the switch and Inverter and ensure that the cable screen is earthed as described in section 10.

12. How to reset the Inverter to Factory Defaults



12.1 Use the navigation pad to navigate to parameter H93.

Press the right navigation key to cycle through the parameter groups until the screen displays "H0".

Press the down arrow repeatedly until "H93" is displayed.



12.2 Press "ENT" to change the value of parameter H93.

Once the display shows "H93", press "ENT" to select the parameter and edit its value.

The display will show the default value of "0".

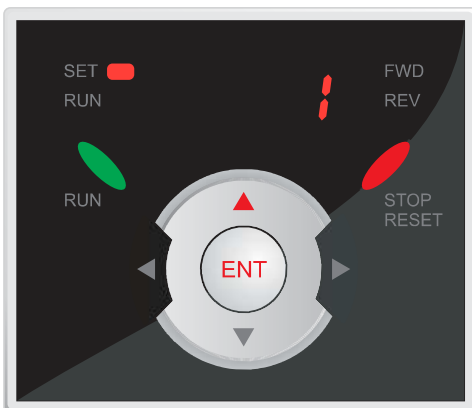

12.3 Press the up arrow on the navigation pad to change the value from 0 to 1.

Press the up arrow on the navigation pad to change the value of H93 from 0 to 1.

Press "ENT" to save the changes. The display will flash to indicate that the change needs to be confirmed.

Press "ENT" again to confirm the change. The display will return to H93.

All parameters have now been reset to factory defaults.