

A L U M I N I U M C O L L E C T I O N

LEGGEREZZA E PRATICITÀ

La bellezza non è ragionevole! Sapienza tecnologica ed all'abilità progettuale, hanno permesso di sperimentare ed utilizzare elementi materici innovativi (quali il marmo ed il cemento) da associare a questa collezione in alluminio.

In sintesi una linea di prodotti versatile, altamente personalizzabile che raccoglie i principi guida di Casa Valentina: scrupoloso lavoro di ricerca, design funzionale e semplicità di utilizzo ed installazione.

Resistente, flessibile e verniciabile l'alluminio permette di realizzare strutture eleganti in diverse conformazioni mantenendo inalterate le sue caratteristiche strutturali di integrità, resistenza ed indeformabilità che ne garantiscono una durata nel tempo.

All'ampia gamma di prodotti di serie Casa Valentina si aggiunge un'infinita possibilità di personalizzazioni cromatiche, di forma o dimensioni per soluzioni abitative intelligenti e funzionali per soddisfare le esigenze più particolari.

LIGHTNESS AND PRACTICAL

Beauty is not reasonable! Technological and design abilities, let us experiment and use innovative materials (such as marble and concrete) to be linked to this aluminium collection.

In summary, a line of versatile products, highly customizable which collects the guiding principles of Casa Valentina: painstaking researches, functional design and functional simplicity of use and installation.

Durable, flexible and paintable, aluminium allows to realize elegant structures in different conformations, by maintaining its structural characteristics of integrity, resistance and dimensional stability guarantee duration in time.

To the wide range of standard products, Casa Valentina adds here a lot of possibilities for chromatic and shape customizations, to meet any possible need.



A L U M I N I U M C O L L E C T I O N

LÉGER ET PRATIQUE

La beauté n'est pas raisonnable! Notre capacité technologique et notre compétence en conception, ils nous permettent d'expérimenter et utiliser des matériaux innovants (tels que le marbre et le béton) à associer à cette collection en aluminium.

En résumé, une gamme de produits polyvalents, hautement personnalisables qui regroupent les principes directeurs de Casa Valentina: recherche minutieuse, simplicité fonctionnelle d'utilisation et d'installation.

Durable, flexible et peignable, l'aluminium permet de réaliser des structures élégantes en différentes conformations, en gardant inchangées ses caractéristiques d'intégrité structurelle; la force et la stabilité dimensionnelle garantissent la durée dans le temps.

À la large gamme de produits standards Casa Valentina, on ajoute une possibilité infinie de personnalisations chromatiques, de forme ou de dimensions pour des solutions résidentielles élégantes et fonctionnelles pour répondre aux besoins les plus exigeants.

LEICHTHEIT UND BRAUCHBARKEIT

Die Schönheit ist nicht vernünftig ! Das Wissen, die Technologie und die Projektfähigkeit haben erlaubt innovative Werkstoffe (wie Marmor und Zement) auszuprobieren und zu benutzen, zusammen mit dieser Kollektion in Aluminium.

Eine vielseitige Produktlinie, die die Grundsätze von Casa Valentina sammelt: sorgfältige Forschung, funktionales Design, Verwendungs- und Einrichtungseinfachheit.

Das Aluminium ist haltbar, biegsam und lackierbar und erlaubt elegante Strukturen auszuführen; es hält seine Struktureigenschaften unverändert, die eine Zeitdauer versichern.

Der reichen Artikelserie von Casa Valentina, kommen die verschiedenen Farben und Varianten mit intelligenten und funktionellen Lösungen hinzu, um die höchsten Sonderwünsche zufrieden zu stellen.



LIGEREZA Y PRACTICIDAD

!La belleza no es razonable. Tecnología y habilidad de diseño han permitido experimentar y utilizar materiales innovadores como el mármol y el cemento a asociar a esta colección de aluminio.

Una línea de productos versátiles, altamente personalizable que recoge los principios base de Casa Valentina: design funcional, facilidad de uso y de instalación.

Resistente y flexible, el aluminio permite crear estructuras elegantes en diferentes conformaciones.

A esta gama de productos estándar de Casa Valentina, se añaden varias posibilidades de personalizaciones de color, de forma o tamaño por soluciones elegantes y funcionales para satisfacer exigencias particulares.

LEKKOŚĆ I PRAKTYCZNOŚĆ

Piękno nie jest rozsądne! Możliwości technologiczne i projektowanie, umiejętność oraz mądrość, pozwoliły eksperymentować i wykorzystywać innowacyjne elementy materialne (takie jak marmur i beton), aby skojarzyć je z tą kolekcją aluminium.

Podsumowując jest to linia produktów uniwersalnych, wysoce konfigurowalnych zawierająca zasady przewodnie Casa Valentina: żmudne badania, rozmyślnie projektowanie a jednocześnie funkcjonalność i prostota obsługi i instalacji.

Mogą być trwałe, elastyczne i pomalowane aluminium pozwala zrealizować struktury eleganckie w różnych konformacjach utrzymując swoje właściwości strukturalną integralność, wytrzymałość i stabilność wymiarową, które gwarantują wartość ponadczasową.

Szeroka gama produktów z serii Casa Valentina daje nieskończone możliwości dostosowania formy, kształtu, wymiaru lub wielkości tak, aby uzyskać rozwiązania inteligentne, funkcjonalne, specyficzne i aby móc zaspokoić potrzeby najbardziej wymagających.



ALUMINIUM COLLECTION



Adele | 22



Aretha | 30



Ave | 42



Ariel | 36



Carmen | 54



Jane | 134



Marcella | 168



Priscilla | 190





Clara | 74



Lucilla Easy | 162



Ketty | 142



Fiorenza | 116



Nadia | 174



Franca | 122



Nina | 182



Tiffany | 210



ALUMINIUM COLLECTION



Carla | 48



Lucilla | 156



Sabina | 204



Cecilia | 62



Ada | 8



Ada Wood | 14



Chiara | 68



Rita | 198



Fiona Basic | 104



Donna | 98



Fiona Fly | 110



Iris | 128



Diva 20 | 82



Lili & Leo | 148



Diva 25 | 90

ALUMINIUM COLLECTION

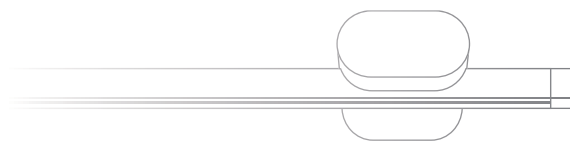

ADA

FINITURE - FINISHES - FINITIONS - FERTIGUNGEN - ACABADOS - WYKOŃCZENIA

18	312	2312
25		6312
67		





Fin. 25

Alluminio colore acciaio satinato
Anodized aluminium steel color
Aluminium anodisé coloris acier

Aluminium eloxiert Stahl Farbe
Aluminio anodizado color acero
Aluminium w kolorze stali matowe



Fin. 6312

Alluminio lucido - Bianco opaco
Bright aluminium - Mat white
Aluminium poli - Blanc mat

Aluminium poliert - Weiss matt
Aluminio pulido - Blanco mate
Aluminium polerowane - Biały matowy

ADA

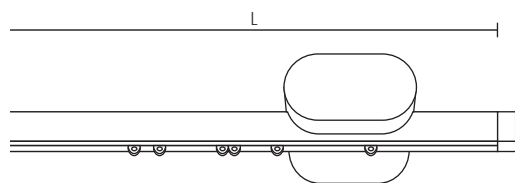

Scorritenda completo a parete
Complete curtain set
Tringle complète pose murale
Komplette Wandgarnitur
Conjunto completo a pared
Karnisz kompletny montaż do ściany

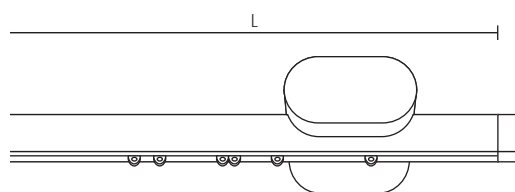

Scorritenda completo a parete
Complete curtain set
Tringle complète pose murale
Komplette Wandgarnitur
Conjunto completo a pared
Karnisz kompletny montaż do ściany

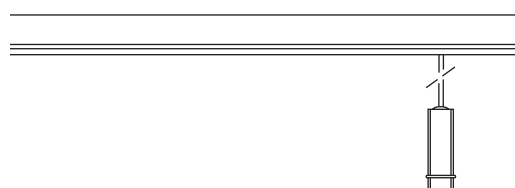

FIN. = Finitura - Finish - Finition - Fertigung - Acabado - Wykonczenie
Prof. = Profilo - Profile - Profil - Profil - Perfil - Profil
Scor. = Scorrevoli - Runners - Glisseurs - Gleiter - Correderas - Ślizgacze
Sup. = Supporti - Brackets - Supports - Träger - Soportes - Wsporniki

Cod. 883A02		∅ 22 mm								
FIN	cm	120	140	160	180	200	220	250	300	340
18		298	308	318	328	338	450	465	489	509
25		298	308	318	328	338	450	465	489	509
67		321	333	344	355	366	485	502	530	552
312		321	333	344	355	366	485	502	530	552
2312		298	308	318	328	338	450	465	489	509
6312		309	321	332	343	354	467	484	512	534
Prof. Cod. 223110										
Scor. Cod. 1000	n.	16	20	22	24	28	30	36	42	46
Sup. cm 9	n.	2	2	2	2	2	3	3	3	3

Cod. 883A03		∅ 30 mm								
FIN	cm	120	140	160	180	200	220	250	300	340
18		284	292	300	308	316	426	438	458	474
25		284	292	300	308	316	426	438	458	474
67		304	313	322	331	339	456	469	491	508
312		304	313	322	331	339	456	469	491	508
2312		284	292	300	308	316	426	438	458	474
6312		292	301	310	319	327	438	451	473	490
Prof. Cod. 313300										
Scor. Cod. 1000	n.	16	20	22	24	28	30	36	42	46
Sup. cm 9	n.	2	2	2	2	2	3	3	3	3

Maggiorazione movimento a corda - Surcharge for corded systems - Supplément pour tirage
Zuschlag für Schnurbedienung - Suplemento por cuerda - Dodatkowo koszt mechanizmu

		∅ 22 mm								
	cm	120	140	160	180	200	220	250	300	340
Prof. Cod. 223110		115	115	115	120	120	120	120	125	125
		∅ 30 mm								
	cm	120	140	160	180	200	220	250	300	340
Prof. Cod. 313300		72	72	72	72	77	77	77	77	77



ADA

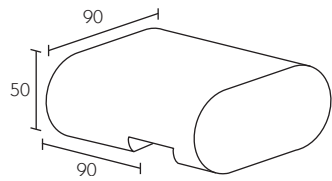

883---

Supporto
Bracket
Support

Träger
Soporte
Wspornik

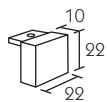

223145

Tappo strappo
Simple endcap
Bouchon simple

Endkappe
Tapón simple
Zatyczka

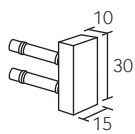

313045

Terminale
Finial
Embout

Endstück
Terminal
Końcówka



12

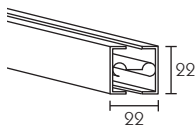

223110

Profilo
Profile
Profil
Profil
Perfil
Profil

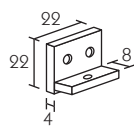

223009

Rosetta a muro
Recess bracket
Naissance murale
Wandlager
Soporte lateral
Podkładka do muru

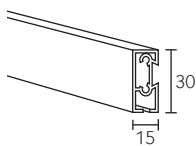

313300

Profilo
Profile
Profil
Profil
Perfil
Profil

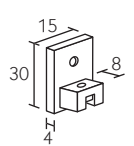

303009

Rosetta a muro
Recess bracket
Naissance murale
Wandlager
Soporte lateral
Podkładka do muru

Cod.		883219	883319
FIN	∅ mm	22	30
	l - mm	90	90
18		102,00	102,00
25		102,00	102,00
67		108,00	108,00
312		102,00	102,00

Cod.		223145
FIN		
18		17,60
25		17,60
67		19,40

Cod.		313045SX / DX
FIN		
18		16,40
25		16,40
67		18,10

Cod.		223110	223009
FIN			
18		48,30	24,00
25		48,30	24,00
67		54,50	25,20
312		54,50	25,20

Cod.		313300	303009
FIN			
18		38,60	26,20
25		38,60	26,20
67		42,50	28,70
312		42,50	28,70

Components

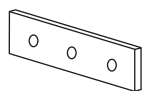

564032
Giunzione
Junction
Jonction

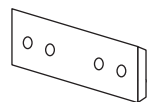

564031
Verbinder
Enchufe
Łącznik



1000
Scorrevole
Runner
Glisseur

Gleiter
Corredera
Ślizgacze

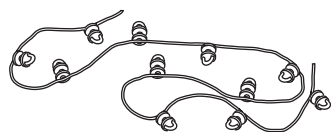

1000--
Scorrevoli
Runners
Glisseurs

Gleiter
Correderas
Ślizgacze

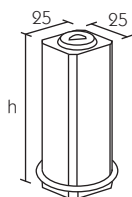

5630--
Fiocco piatto
Flat weight
Contrepoids plat

Schnurbeschwerer
Contrapeso plano
Obciążnik płaski

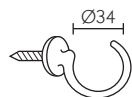

546003
Gancio
Hook
Crochet

Hacken
Gancho
Haczyki

Cod.		564032	564031
FIN	∅ mm	22x22	30x15
		24,40	24,40

Cod.		1000
FIN		0,08

Cod.		1000P6*	1000P8**
FIN			
Euro/mt		6,74	6,74

* Scorrevoli passo 60 mm - Runners each 60 mm - Glisseurs tous les 60 mm - Gleiter je 60 mm - Correderas cada 60 mm - Ślizgi co 60 mm
** Scorrevoli passo 80 mm - Runners each 80 mm - Glisseurs tous les 80 mm - Gleiter je 80 mm - Correderas cada 80 mm - Ślizgi co 80 mm

Cod.		563007	563008
FIN	h - mm	80	100
18		23,50	26,00
25		23,50	26,00
67		26,00	31,00
312		26,00	31,00

Cod.		546003
FIN		
09		5,00



ALUMINIUM COLLECTION



14

ADA WOOD

FINITURE - FINISHES - FINITIONS - FERTIGUNGEN - ACABADOS - WYKOŃCZENIA

25 B

67 Q

99 V



ADA WOOD



Fin. 67V

Alluminio lucido - Rovere venatura bianca
Bright aluminium - Oak white grain
Aluminium poli - Chêne grain blanc

Aluminium poliert - Eiche weisse Flader
Aluminio pulido - Roble con veta blanca
Aluminium polerowane - Dąb słoje białe



Fin. 67Q

Alluminio lucido - Rovere venatura grigia
Bright aluminium - Oak grey grain
Aluminium poli - Chêne grain gris

Aluminium poliert - Eiche graue Flader
Aluminio pulido - Roble con veta gris
Aluminium polerowane - Dąb słoje szare

ADA WOOD

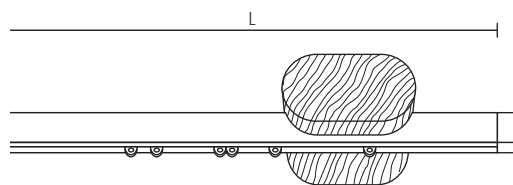

Scorritenda completo a parete
Complete curtain set
Tringle complète pose murale
Komplette Wandgarnitur
Conjunto completo a pared
Karnisz kompletny montaż do ściany

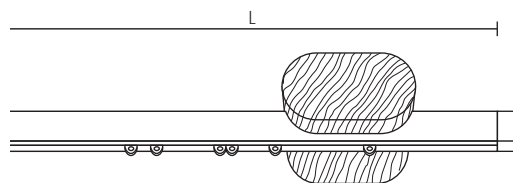

Scorritenda completo a parete
Complete curtain set
Tringle complète pose murale
Komplette Wandgarnitur
Conjunto completo a pared
Karnisz kompletny montaż do ściany

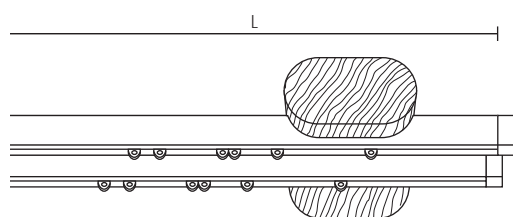

Scorritenda completo doppio a parete
Complete double curtain set
Tringle complète double pose murale
Komplette Doppelgarnitur
Conjunto completo doble a pared
Karnisz podwójny kompletny montaż do ściany

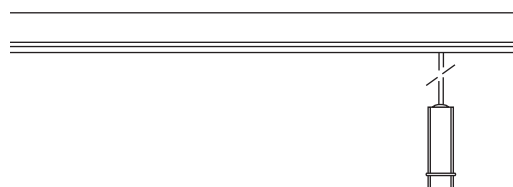

FIN. = Finitura - Finish - Finition - Fertigung - Acabado - Wykonczenie
Prof. = Profilo - Profile - Profil - Profil - Perfil - Profil
Scor. = Scorrevoli - Runners - Glisseurs - Gleiter - Correderas - Ślizgacze
Sup. = Supporti - Brackets - Supports - Träger - Soportes - Wsporniki

Cod. 885A02		∅ 22 mm								
FIN	cm	120	140	160	180	200	220	250	300	340
25 B - Q - V		272	282	292	302	312	411	426	450	470
67 B - Q - V		283	295	306	317	328	428	445	473	495
99 B - Q - V		299	312	324	337	350	452	471	503	528
Prof. Cod. 223110										
Scor. Cod. 1000	n.	16	20	22	24	28	30	36	42	46
Sup. cm 9	n.	2	2	2	2	2	3	3	3	3

Cod. 885B02		∅ 22 mm								
FIN	cm	120	140	160	180	200	220	250	300	340
25 B - Q - V		294	304	314	324	334	444	459	483	503
67 B - Q - V		305	317	328	339	350	461	478	506	528
99 B - Q - V		321	334	346	359	372	485	504	536	561
Prof. Cod. 223110										
Scor. Cod. 1000	n.	16	20	22	24	28	30	36	42	46
Sup. cm 15	n.	2	2	2	2	2	3	3	3	3

Cod. 885C02		∅ 22 mm								
FIN	cm	120	140	160	180	200	220	250	300	340
25 B - Q - V		409	429	448	468	488	618	648	697	736
67 B - Q - V		431	453	476	498	520	652	686	741	786
99 B - Q - V		461	487	512	538	564	699	738	802	852
Prof. Cod. 223110										
Scor. Cod. 1000	n.	16/16	20/20	22/22	24/24	28/28	30/30	36/36	42/42	46/46
Sup.	n.	2	2	2	2	2	3	3	3	3

Maggiorazione movimento a corda - Surcharge for corded systems - Supplément pour tirage
Zuschlag für Schnurbedienung - Suplemento por cuerda - Dodatkowo koszt mechanizmu

Prof. Cod. 223110	cm	120	140	160	180	200	220	250	300	340
		115	115	115	120	120	120	120	125	125



ADA WOOD

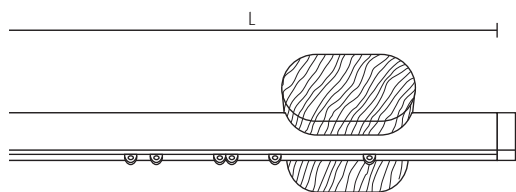

Scorritenda completo a parete
Complete curtain set
Tringle complète pose murale
Komplette Wandgarnitur
Conjunto completo a pared
Karnisz kompletny montaż do ściany

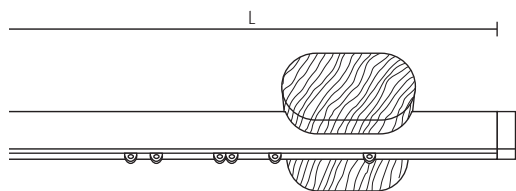

Scorritenda completo a parete
Complete curtain set
Tringle complète pose murale
Komplette Wandgarnitur
Conjunto completo a pared
Karnisz kompletny montaż do ściany



18

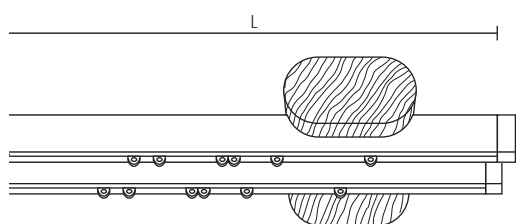

Scorritenda completo doppio a parete
Complete double curtain set
Tringle complète double pose murale
Komplette Doppelgarnitur
Conjunto completo doble a pared
Karnisz podwójny kompletny montaż do ściany

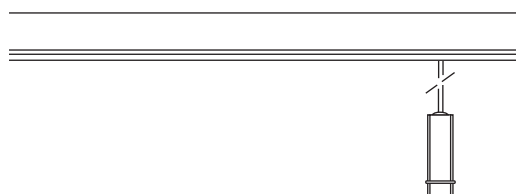

FIN. = Finitura - Finish - Finition - Fertigung - Acabado - Wykonczenie
Prof. = Profilo - Profile - Profil - Profil - Perfil - Profil
Scor. = Scorrevoli - Runners - Glisseurs - Gleiter - Correderas - Ślizgacze
Sup. = Supporti - Brackets - Supports - Träger - Soportes - Wsporniki

Cod. 885A03		∅ 30 mm								
FIN	cm	120	140	160	180	200	220	250	300	340
25 B - Q - V		258	266	274	282	290	387	399	419	435
67 B - Q - V		266	275	284	293	301	399	412	434	451
99 B - Q - V		279	289	300	310	320	419	435	461	481

Prof. Cod. 313300										
Scor. Cod. 1000	n.	16	20	22	24	28	30	36	42	46
Sup. cm 9	n.	2	2	2	2	2	3	3	3	3

Cod. 885B03		∅ 30 mm								
FIN	cm	120	140	160	180	200	220	250	300	340
25 B - Q - V		280	288	296	304	312	420	432	452	468
67 B - Q - V		288	297	306	315	323	432	445	467	484
99 B - Q - V		301	311	322	332	342	452	468	494	514

Prof. Cod. 313300										
Scor. Cod. 1000	n.	16	20	22	24	28	30	36	42	46
Sup. cm 15	n.	2	2	2	2	2	3	3	3	3

Cod. 885C03		∅ 30 mm								
FIN	cm	120	140	160	180	200	220	250	300	340
25 B - Q - V		381	397	413	428	444	570	594	634	665
67 B - Q - V		397	415	432	449	467	594	621	664	699
99 B - Q - V		422	443	463	484	504	635	666	717	758

Prof. Cod. 313300										
Scor. Cod. 1000	n.	16/16	20/20	22/22	24/24	28/28	30/30	36/36	42/42	46/46
Sup.	n.	2	2	2	2	2	3	3	3	3

Maggiorazione movimento a corda - Surcharge for corded systems - Supplément pour tirage
Zuschlag für Schnurbedienung - Suplemento por cuerda - Dodatkowo koszt mechanizmu

Prof. Cod. 313300										
cm		120	140	160	180	200	220	250	300	340
		72	72	72	72	77	77	77	77	77

Components

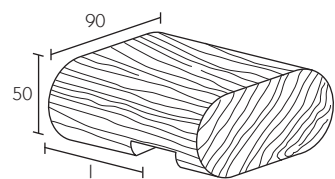

2252-- 2253--

Supporto
Bracket
Support

Träger
Soporte
Wspornik

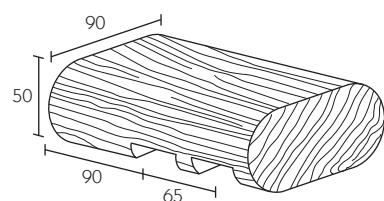

885217 885317

Supporto doppio
Double bracket
Support double

Doppelträger
Soporte doble
Wspornik podwójny

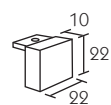

223145

Tappo strappo
Simple endcap
Bouchon simple

Endkappe
Tapón simple
Zatyczka

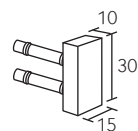

313045

Terminale
Finial
Embout

Endstück
Terminal
Końcówka

Cod.		885219	885229	885319	885329
FIN	∅ mm	22	22	30	30
	l - mm	90	150	90	150
B		89,00	100,00	89,00	100,00
Q		89,00	100,00	89,00	100,00
V		89,00	100,00	89,00	100,00

Cod.		885217	885317
FIN	∅ mm	22	30
	l - mm	90	90
B		110,00	110,00
Q		110,00	110,00
V		110,00	110,00

Cod.	223145
FIN	
25	17,60
67	19,40
99	22,00

Cod.	313045SX / DX
FIN	
25	16,40
67	18,10
99	19,80



ADA WOOD

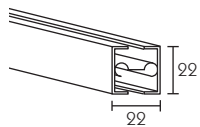

223110

Profilo
Profile
Profil
Profil
Perfil
Profil

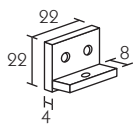

223009

Rosetta a muro
Recess bracket
Naissance murale
Wandlager
Soporte lateral
Podkładka do muru

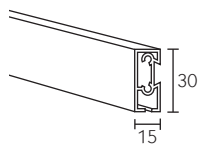

313300

Profilo
Profile
Profil
Profil
Perfil
Profil

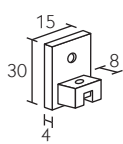

303009

Rosetta a muro
Recess bracket
Naissance murale
Wandlager
Soporte lateral
Podkładka do muru



20

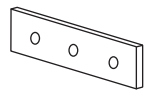

564032

Giunzione
Junction
Jonction



564031

Verbinder
Enchufe
Łącznik

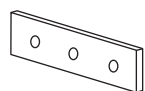

564032

Giunzione
Junction
Jonction

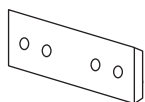

564031

Verbinder
Enchufe
Łącznik

Cod.	223110	223009
FIN		
25	48,30	24,00
67	54,50	25,20
99	62,80	27,70

Cod.	313300	303009
FIN		
25	38,60	26,20
67	42,50	28,70
99	50,20	31,60

Cod.	564032
FIN	
Ø mm	22 x 22
	24,40

Cod.	564031
FIN	
Ø mm	30 x 15
	24,40

Components



1000

Scorrevole
Runner
Glisseur

Gleiter
Corredera
Slizgacze

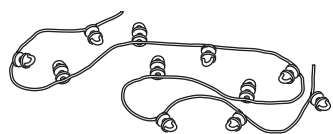

1000--

Scorrevoli
Runners
Glisseurs

Gleiter
Correderas
Slizgacze

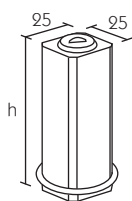

5630--

Fiocco piatto
Flat weight
Contrepoids plat

Schnurbeschwerer
Contrapeso plano
Obciążnik płaski

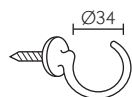

546003

Gancio
Hook
Crochet

Hacken
Gancho
Haczyki

Cod.	1000
FIN	0,08

Cod.	1000P6*	1000P8**
FIN		
Euro/mt	6,74	6,74

* Scorrevoli passo 60 mm - Runners each 60 mm - Glisseurs tous les 60 mm - Gleiter je 60 mm - Correderas cada 60 mm - Ślizgi co 60 mm
** Scorrevoli passo 80 mm - Runners each 80 mm - Glisseurs tous les 80 mm - Gleiter je 80 mm - Correderas cada 80 mm - Ślizgi co 80 mm

Cod.		563007	563008
FIN	h - mm	80	100
25		23,50	26,00
67		26,00	31,00
99		30,00	34,00



ALUMINIUM COLLECTION



ADELE

FINITURE - FINISHES - FINITIONS - FERTIGUNGEN - ACABADOS - WYKOŃCZENIA

25	BNL	A
67		B
99		H
		J
		K
		W



ADELE



Fin. 25

Alluminio colore acciaio satinato
Anodized aluminium steel color
Aluminium anodisé coloris acier

Aluminium eloxiert Stahl Farbe
Aluminio anodizado color acero
Aluminium w kolorze stali matowe



Fin. 99

Alluminio bronzo lucido
Aluminium bright bronze
Aluminium bronze poli

Aluminium Bronz glänzend
Aluminio bronze pulido
Aluminium brąz poler

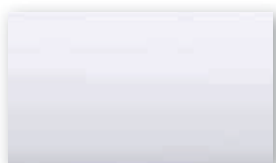

Fin. 67

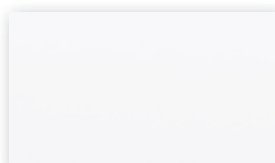

Fin. BNL



Fin. A-H



Fin. B-K



Fin. J-W

H 1:1

ADELE

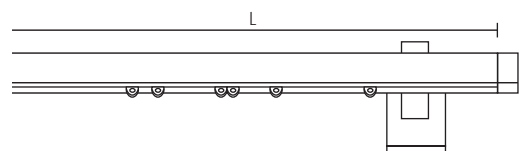

Scorritenda completo a parete
Complete curtain set
Tringle complète pose murale
Komplette Wandgarnitur
Conjunto completo a pared
Karnisz kompletny montaż do ściany

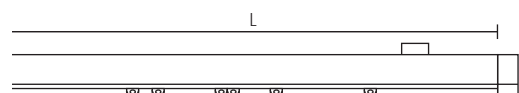

Scorritenda completo a soffitto
Complete curtain set with ceiling bracket
Tringle complète à plafond
Komplette Deckengarnitur
Conjunto completo a techo
Karnisz kompletny do sufitu

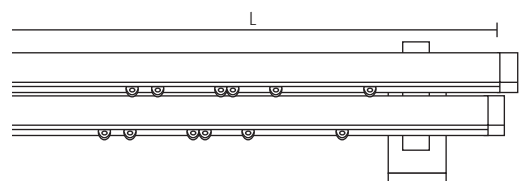

Scorritenda completo doppio a parete
Complete double curtain set
Tringle complète double pose murale
Komplette Doppelgarnitur
Conjunto completo doble a pared
Karnisz podwójny kompletny montaż do ściany

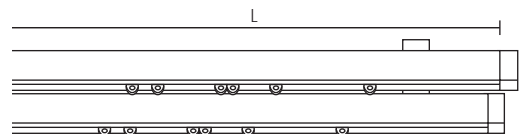

Scorritenda completo doppio a soffitto
Complete double curtain set with ceiling bracket
Tringle complète double à plafond
Komplette Decken-Doppelgarnitur
Conjunto completo doble a techo
Karnisz kompletny podwójny do sufitu

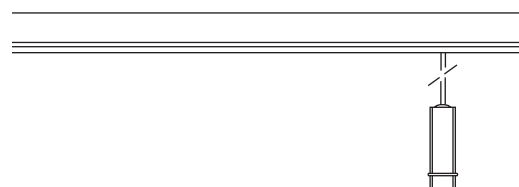

FIN. = Finitura - Finish - Finition - Fertigung - Acabado - Wykonczenie
Scor. = Scorrevoli - Runners - Glisseurs - Gleiter - Correderas - Ślizgacze
Sup. = Supporti - Brackets - Supports - Träger - Soportes - Wsporniki

Cod. 223A45

FIN	cm	120	140	160	180	200	220	250	300	340
25		196	206	215	225	235	296	311	335	355
67		217	228	239	250	261	328	345	373	395
99		242	255	268	280	293	367	386	418	443
25 A - B - W		170	175	181	186	192	248	256	270	281
67 A - B - W		183	189	195	200	206	267	275	289	300
Scor. Cod. 1000	n.	16	20	22	24	28	30	36	42	46
Sup. cm 9	n.	2	2	2	2	2	3	3	3	3

Cod. 223S45

FIN	cm	120	140	160	180	200	220	250	300	340
25		156	166	176	186	196	237	252	276	296
67		173	185	196	207	218	263	280	308	330
99		195	208	220	233	246	296	315	347	373
25 A - B - W		130	136	141	147	152	189	197	211	222
67 A - B - W		140	146	151	157	162	202	210	224	235
Scor. Cod. 1000	n.	16	20	22	24	28	30	36	42	46
Sup.	n.	2	2	2	2	2	3	3	3	3

Cod. 223C45

FIN	cm	120	140	160	180	200	220	250	300	340
25		332	352	371	391	411	502	532	581	620
67		368	391	413	435	457	558	592	647	691
99		413	438	464	489	515	626	665	729	780
25 A - B - W		280	291	302	313	324	406	423	451	473
67 A - B - W		301	312	323	334	346	435	452	480	502
Scor. Cod. 1000	n.	16/16	20/20	22/22	24/24	28/28	30/30	36/36	42/42	46/46
Sup. cm 9	n.	2	2	2	2	2	3	3	3	3

Cod. 223T45

FIN	cm	120	140	160	180	200	220	250	300	340
25		275	295	315	335	355	418	448	497	536
67		306	329	351	373	395	465	499	554	598
99		345	371	396	422	448	525	564	628	678
25 A - B - W		223	235	246	257	268	322	339	367	389
67 A - B - W		239	250	261	272	284	342	359	387	409
Scor. Cod. 1000	n.	16/16	20/20	22/22	24/24	28/28	30/30	36/36	42/42	46/46
Sup.	n.	2	2	2	2	2	3	3	3	3

Maggiorazione movimento a corda - Surcharge for corded systems - Supplément pour tirage
Zuschlag für Schnurbedienung - Suplemento por cuerda - Dodatkowo koszt mechanizmu

cm	120	140	160	180	200	220	250	300	340
	115	115	115	120	120	120	120	125	125



ADELE PLUS

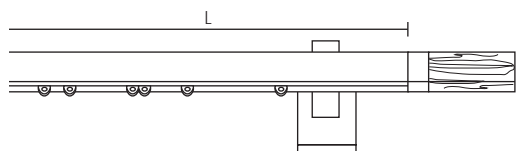

Scorritenda completo a parete
Complete curtain set
Tringle complète pose murale
Komplette Wandgarnitur
Conjunto completo a pared
Karnisz kompletny montaż do ściany

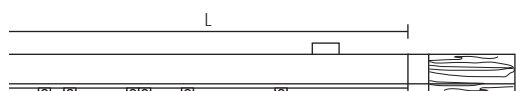

Scorritenda completo a soffitto
Complete curtain set with ceiling bracket
Tringle complète à plafond
Komplette Deckengarnitur
Conjunto completo a techo
Karnisz kompletny do sufitu

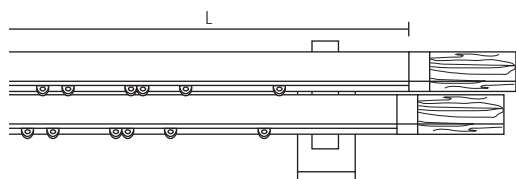

Scorritenda completo doppio a parete
Complete double curtain set
Tringle complète double pose murale
Komplette Doppelgarnitur
Conjunto completo doble a pared
Karnisz podwójny kompletny montaż do ściany

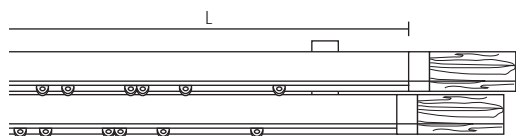

Scorritenda completo doppio a soffitto
Complete double curtain set with ceiling bracket
Tringle complète double à plafond
Komplette Decken-Doppelgarnitur
Conjunto completo doble a techo
Karnisz kompletny podwójny do sufitu

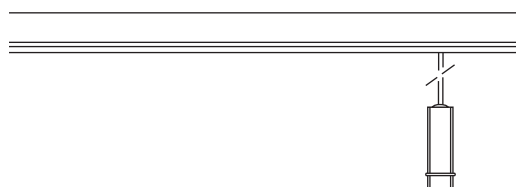

FIN. = Finitura - Finish - Finition - Fertigung - Acabado - Wykonczenie
Scor. = Scorrevoli - Runners - Glisseurs - Gleiter - Correderas - Ślizgacze
Sup. = Supporti - Brackets - Supports - Träger - Soportes - Wsporniki

Cod. 223P45

FIN	cm	120	140	160	180	200	220	250	300	340
25 A - B - W		236	246	256	266	276	336	351	376	396
25 H - K - J		261	272	283	294	306	372	389	417	439
67 A - B - W		210	216	222	227	233	289	297	311	322
67 H - K - J		228	233	239	244	250	311	319	333	344
Scor. Cod. 1000	n.	16	20	22	24	28	30	36	42	46
Sup. cm 9	n.	2	2	2	2	2	3	3	3	3

Cod. 223U45

FIN	cm	120	140	160	180	200	220	250	300	340
25 A - B - W		197	207	217	227	237	277	292	317	337
25 H - K - J		218	229	240	251	262	307	324	352	374
67 A - B - W		171	177	182	188	193	230	238	252	263
67 H - K - J		184	190	195	201	206	246	254	268	279
Scor. Cod. 1000	n.	16	20	22	24	28	30	36	42	46
Sup.	n.	2	2	2	2	2	3	3	3	3

Cod. 223L45

FIN	cm	120	140	160	180	200	220	250	300	340
25 A - B - W		413	433	453	473	492	584	613	663	702
25 H - K - J		457	479	501	523	546	646	680	736	780
67 A - B - W		361	372	383	394	406	488	505	533	554
67 H - K - J		390	401	412	423	434	524	541	568	590
Scor. Cod. 1000	n.	16/16	20/20	22/22	24/24	28/28	30/30	36/36	42/42	46/46
Sup. cm 9	n.	2	2	2	2	2	3	3	3	3

Cod. 223V45

FIN	cm	120	140	160	180	200	220	250	300	340
25 A - B - W		357	377	397	416	436	499	529	578	618
25 H - K - J		395	417	439	461	484	553	587	643	687
67 A - B - W		305	316	327	338	349	404	421	448	470
67 H - K - J		328	339	350	361	372	431	448	475	497
Scor. Cod. 1000	n.	16/16	20/20	22/22	24/24	28/28	30/30	36/36	42/42	46/46
Sup.	n.	2	2	2	2	2	3	3	3	3

Maggiorazione movimento a corda - Surcharge for corded systems - Supplément pour tirage
Zuschlag für Schnurbedienung - Suplemento por cuerda - Dodatkowo koszt mechanizmu

cm	120	140	160	180	200	220	250	300	340
	115	115	115	120	120	120	120	125	125

Components

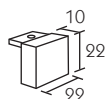

223145

Tappo strappo
Simple endcap
Bouchon simple

Endkappe
Tapón simple
Zatyczka

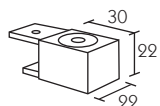

223155

Tappo ritorno corda
Endcap return pulley
Bouchon contrepoulie

Rückschnurkappe
Tapón contrapolea
Zatyczka do sznurka

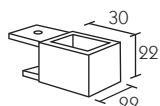

223165

Tappo discesa corda
Endcap cord fall
Bouchon sortie cordon

Schnurseitekappe
Tapón salida cuerda
Zatyczka do sznurka

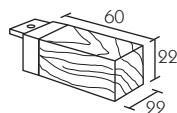

223245

Tappo Plus strappo
Simple endcap Plus
Bouchon Plus simple

Endkappe Plus
Tapón Plus simple
Zatyczka Plus

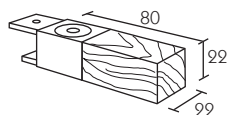

223255

Tappo Plus ritorno corda
Endcap Plus return pulley
Bouchon Plus contrepoulie

Rückschnurkappe Plus
Tapón Plus contrapolea
Zatyczka Plus do sznurka

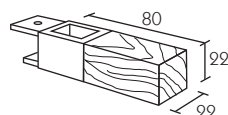

223265

Tappo Plus discesa corda
Endcap Plus cord fall
Bouchon Plus sortie cordon

Schnurseitekappe Plus
Tapón Plus salida cuerda
Zatyczka Plus do sznurka

Cod.	223145
FIN	
25	17,60
67	19,40
99	22,00

Cod.	223155
FIN	
25	39,10
67	43,00
99	46,90

Cod.	223165
FIN	
25	39,10
67	43,00
99	46,90

Cod.	223245
FIN	
25 A - B - W	38,00
67 A - B - W	41,50

Cod.	223255
FIN	
25 A - B - W	59,50
67 A - B - W	62,30

Cod.	223265
FIN	
25 A - B - W	59,50
67 A - B - W	62,30



ADELE

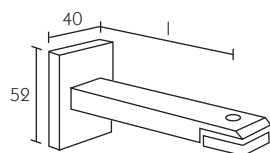

223418

Supporto
Bracket
Support

Träger
Soporte
Wspornik

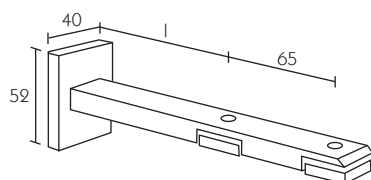

223427

Supporto doppio
Double bracket
Support double

Doppelträger
Soporte doble
Wspornik podwójny

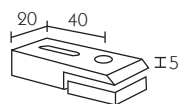

223997

Supporto a soffitto
Ceiling bracket
Support à plafond

Deckenträger
Soporte a techo
Wspornik do sufitu

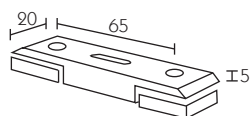

223998

Supporto doppio a soffitto
Double ceiling bracket
Support à plafond double

Decken-Doppelträger
Soporte doble a techo
Wspornik podwójny do sufitu

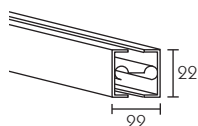

223110

Profilo
Profile
Profil

Profil
Perfil
Profil

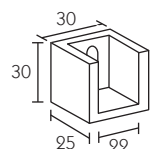

223001

Rosetta a muro
Recess bracket
Naissance murale

Wandlager
Soporte lateral
Podkładka do muru

Cod.		223418	223428	223438
FIN	I - mm	90	160	210
25		50,60	57,30	64,00
67		55,70	63,00	70,40
99		60,70	68,80	76,80

Cod.		223417	223427
FIN	I - mm	90 - 160	160 - 210
25		71,40	77,60
67		78,60	85,40
99		85,70	93,10

Cod.		223997
FIN		
25		30,90
67		34,00
99		37,10

Cod.		223998
FIN		
25		43,30
67		47,60
99		52,00

Cod.		223110
FIN		
25		48,30
67		54,50
99		62,80
BNL		54,50
A - B - W		26,60

Cod.		223001SX / DX
FIN		
25		22,00
67		23,20
99		26,00



Components

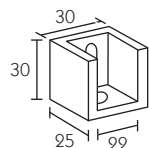

223002

Rosetta per corda
Recess bracket for corded
Naissance pour tirage

Wandlager für Schnur
Soporte para cordon
Przytrzymanie do sznura



1000

Scorrevole
Runner
Glisseur



1001

Gleiter
Corredera
Ślizgacze

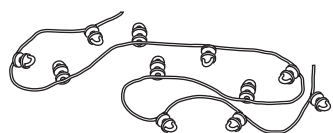

1000--

Scorrevoli
Runners
Glisseurs

Gleiter
Correderas
Ślizgacze

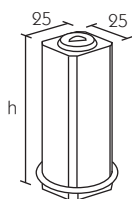

5630--

Fiocco piatto
Flat weight
Contrepoids plat

Schnurbeschwerer
Contrapeso plano
Obciążnik płaski

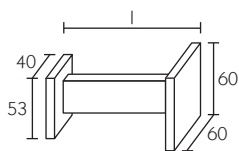

5130--

Fermatenda
Holdback
Porte-embrasse

Raffhalter
Alzapaño
Przytrzymanie firanki

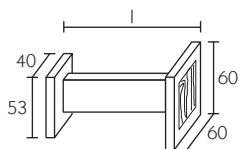

5130--

Fermatenda
Holdback
Porte-embrasse

Raffhalter
Alzapaño
Przytrzymanie firanki

Cod.	223002SX / DX	
FIN		
25	24,00	
67	25,20	
99	28,00	

Cod.	1000	1001
FIN		
	0,08	0,61

Cod.	1000P6*	1000P8**
FIN		
Euro/mt	6,74	6,74

* Scorrevoli passo 60 mm - Runners each 60 mm - Glisseurs tous les 60 mm - Gleiter je 60 mm - Correderas cada 60 mm - Ślizgi co 60 mm
** Scorrevoli passo 80 mm - Runners each 80 mm - Glisseurs tous les 80 mm - Gleiter je 80 mm - Correderas cada 80 mm - Ślizgi co 80 mm

Cod.		563007	563008
FIN	h - mm	80	100
25		23,50	26,00
67		26,00	31,00
99		30,00	34,00

Cod.		513031	513032	513033
FIN	l - mm	100	150	200
25		76,70	81,70	86,70
67		84,30	89,90	95,50
99		115,00	121,50	128,00

Cod.		513094	513095	513096
FIN	l - mm	100	150	200
25 A - B - W		90,70	95,70	100,70
67 A - B - W		98,30	103,90	109,50



ALUMINIUM COLLECTION



ARETHA

FINITURE - FINISHES - FINITIONS - FERTIGUNGEN - ACABADOS - WYKOŃCZENIA

67	A	AR
81	B	AV
	C	BL
	D	GI
	W	RO
		VA



ARETHA

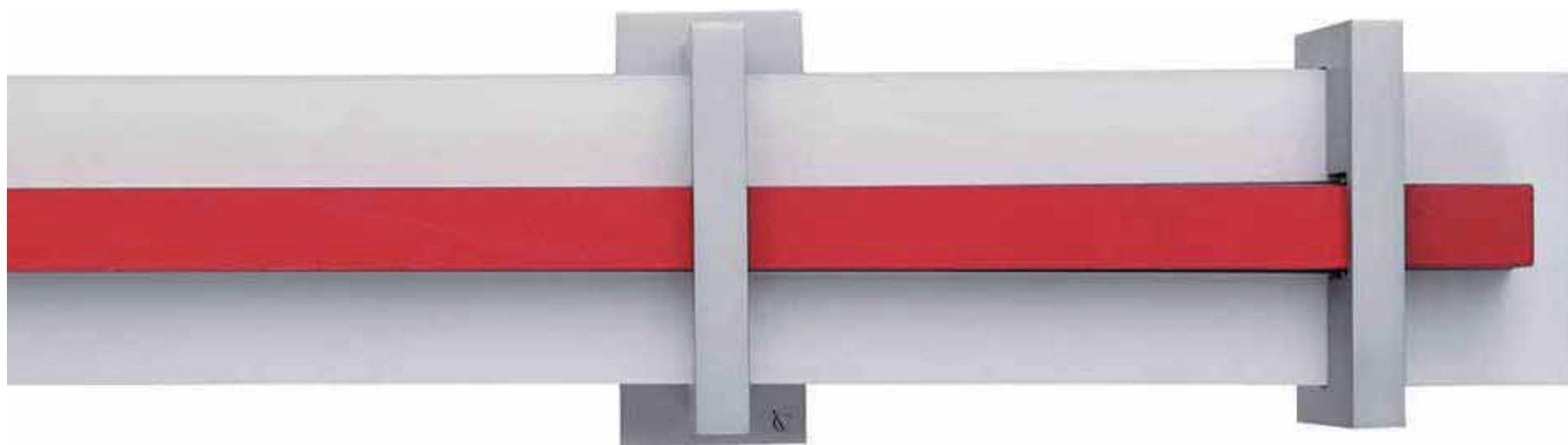

Fin. 81RO

Alluminio satinato opaco - Rosso

Satin mat aluminium - Red

Aluminium satiné mat - Rouge

Aluminium satiniert matt - Rot

Aluminio satinado mate - Rojo

Aluminium satynowy matowy - Czerwony



Fin. 81

Alluminio satinato opaco

Satin mat aluminium

Aluminium satiné mat

Aluminium satiniert matt

Aluminio satinado mate

Aluminium satynowy matowy

ARETHA

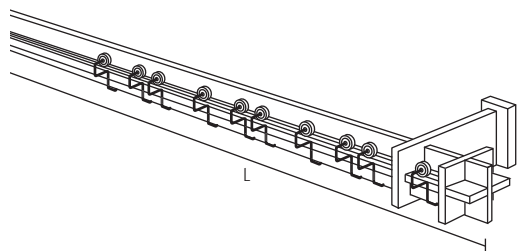

Scorritenda completo a parete
Complete curtain set
Tringle complète pose murale
Komplette Wandgarnitur
Conjunto completo a pared
Karnisz kompletny montaż do ściany

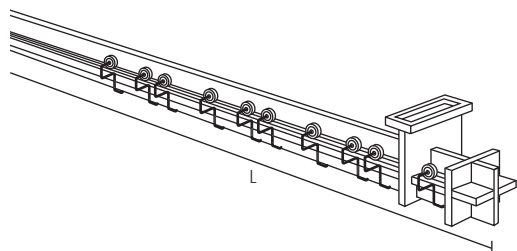

Scorritenda completo a soffitto
Complete curtain set with ceiling bracket
Tringle complète à plafond
Komplette Deckengarnitur
Conjunto completo a techo
Karnisz kompletny do sufitu

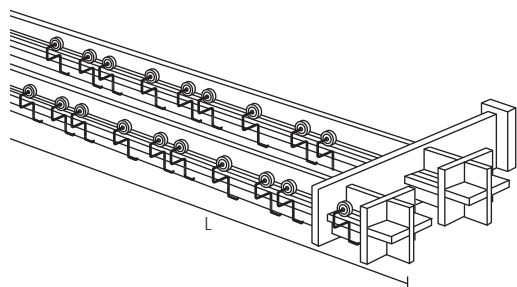

Scorritenda completo doppio a parete
Complete double curtain set
Tringle complète double pose murale
Komplette Doppelgarnitur
Conjunto completo doble a pared
Karnisz podwójny kompletny montaż do ściany

FIN. = Finitura - Finish - Finition - Fertigung - Acabado - Wykonczenie
Scor. = Scorrevoli - Runners - Glisseurs - Gleiter - Correderas - Ślizgacze
Sup. = Supporti - Brackets - Supports - Träger - Soportes - Wsporniki

Cod. 643S02

FIN	cm	160	180	200	220	250	300	340
67 AR - AV - BL - GI - RO - VA		441	466	492	591	631	693	744
67 - 67 A - B - C - D - W		443	471	499	599	643	710	765
81 AR - AV - BL - GI - RO - VA		397	422	448	532	572	633	684
81 - 81 A - B - C - D - W		400	427	454	541	584	650	704
Scor.	n.	16	18	20	22	26	30	34
Sup. cm 8	n.	2	2	2	3	3	3	3

Cod. 643T02

FIN	cm	160	180	200	220	250	300	340
67 AR - AV - BL - GI - RO - VA		448	473	499	601	641	703	754
67 - 67 A - B - C - D - W		450	478	505	609	653	720	775
81 AR - AV - BL - GI - RO - VA		402	427	452	539	579	640	690
81 - 81 A - B - C - D - W		404	431	459	548	590	656	711
Scor.	n.	16	18	20	22	26	30	34
Sup. cm 14	n.	2	2	2	3	3	3	3

Cod. 643L02

FIN	cm	160	180	200	220	250	300	340
67 AR - AV - BL - GI - RO - VA		438	464	490	537	577	639	690
67 - 67 A - B - C - D - W		441	469	496	545	589	656	711
81 AR - AV - BL - GI - RO - VA		395	420	446	491	531	592	642
81 - 81 A - B - C - D - W		398	425	452	499	542	608	663
Scor.	n.	16	18	20	22	26	30	34
Sup. cm 4,5	n.	2	2	2	3	3	3	3

Cod. 643U02

FIN	cm	160	180	200	220	250	300	340
67 AR - AV - BL - GI - RO - VA		760	811	863	998	1.079	1.203	1.305
67 - 67 A - B - C - D - W		765	821	876	1.015	1.102	1.236	1.347
81 AR - AV - BL - GI - RO - VA		693	744	794	912	992	1.114	1.215
81 - 81 A - B - C - D - W		698	753	807	929	1.014	1.147	1.255
Scor.	n.	16/16	18/18	20/20	22/22	26/26	30/30	34/34
Sup. cm 8	n.	2	2	2	3	3	3	3



ARETHA

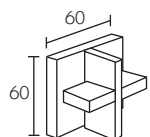

643002

Terminale
Finial
Embout

Endstück
Terminal
Końcówka

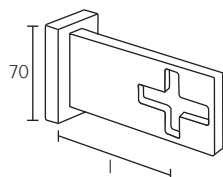

6430--

Supporto
Bracket
Support

Träger
Soporte
Wspornik

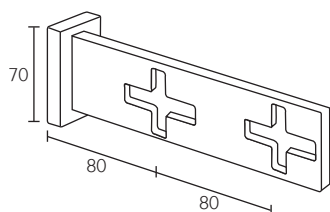

643017

Supporto doppio
Double bracket
Support double

Doppelträger
Soporte doble
Wspornik podwójny



34

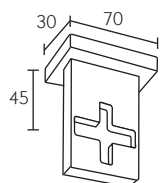

643048

Supporto a soffitto
Ceiling bracket
Support à plafond

Deckenträger
Soporte a techo
Wspornik do sufitu

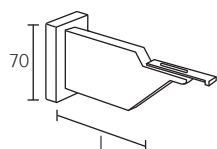

6430--

Supporto intermedio
Central bracket
Support intermédiaire

Mittelträger
Soporte intermedio
Wspornik środkowy

Cod.	643002			
FIN				
67 AR - AV - BL - GI - RO - VA			47,20	
67 - 67 A - B - C - D - W			40,50	
81 AR - AV - BL - GI - RO - VA			40,50	
81 - 81 A - B - C - D - W			33,70	

Cod.	643008 643018 643028 643038				
FIN	l - mm	80	140	180	230
67		70,80	74,20	77,50	80,90
81		57,30	59,60	61,80	64,00

Cod.	643017	
FIN	l - mm	80
67		80,90
81		64,10

Cod.	643048	
FIN	l - mm	45
67		69,60
81		56,30

Cod.	643009 643019 643029 643039				
FIN	l - mm	80	140	180	230
67		73,10	76,40	79,80	82,00
81		59,60	61,80	64,00	66,00

Components

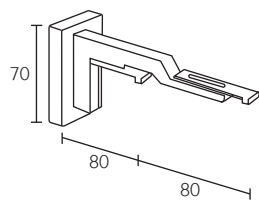

643027

Supporto intermedio doppio
Central double bracket
Support intermédiaire double
Mitteldoppelträger
Soporte intermedio doble
Wspornik środkowy podwójny



643049

Supporto intermedio a soffitto
Central Aretha ceiling bracket
Support intermédiaire à plafond
Deckenmittelträger
Soporte intermedio techo
Wspornik środkowy do sufitu

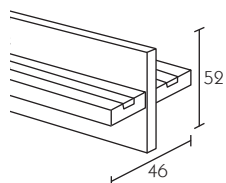

643100

Profilo in alluminio
Aluminium profile
Profil en aluminium

Profil aus Alu
Perfil en aluminio
Profil aluminiowy

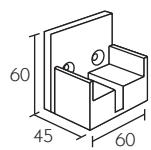

643001

Rosetta a muro
Recess bracket
Naissance murale
Wandlager
Soporte lateral
Podkładka do muru

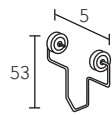

524053

Scorrevole
Runner
Glisseur
Gleiter
Corredera
Slizgacze

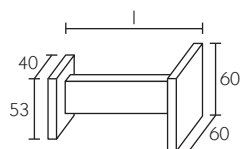

5130--

Fermatenda
Holdback
Porte-embrasse

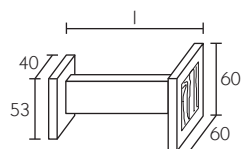

Raffhalter
Alzapaño
Przytrzymanie firanki

Cod.		643027
FIN	mm	80
67		84,30
81		67,50

Cod.		643049
FIN	mm	45
67		21,40
81		20,20

Cod.		643100
FIN		
67 AR - AV - BL - GI - RO - VA		107,00
67 - 67 A - B - C - D - W		117,00
81 AR - AV - BL - GI - RO - VA		107,00
81 - 81 A - B - C - D - W		117,00

Cod.	643001	524053
FIN		
67	67,50	
81	54,00	
97		1,90
98		2,10

Cod.		513031	513032	513033	513094	513095	513096
FIN	l - mm	100	150	200	100	150	200
67		84,30	89,90	95,50			
81		69,00	73,50	78,00			
67 AR - AV - BL - GI - RO - VA					98,30	103,90	109,50
67 - 67 A - B - C - D - W					98,30	103,90	109,50
81 AR - AV - BL - GI - RO - VA					83,00	87,50	92,00
81 - 81 A - B - C - D - W					83,00	87,50	92,00



ALUMINIUM COLLECTION

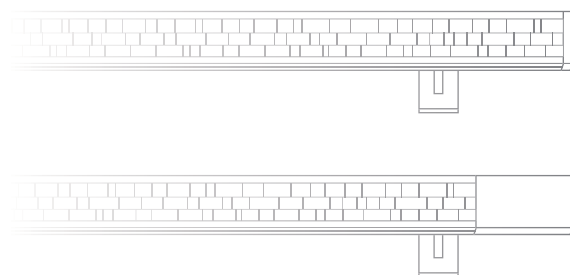

ARIEL

FINITURE - FINISHES - FINITIONS - FERTIGUNGEN - ACABADOS - WYKOŃCZENIA

67	MB	131	135
81	MG	132	136
	MR	133	137
		134	



ARIEL



Fin. 67MB

Alluminio lucido - Madreperla bianco
Bright aluminium - White mother of pearl
Aluminium poli - Nacre blanche

Aluminium poliert - Perlmutter weiss
Aluminio pulido - Nácar blanco
Aluminium polerowane - Masa perłowa biała



Fin. 81MR

Alluminio satinato opaco - Madreperla rosa
Satin mat aluminium - Pink mother of pearl
Aluminium satiné mat - Nacre rose

Aluminium satiniert matt - Perlmutter rosa
Aluminio satinado mate - Nácar rosa
Aluminium satynowy matowy - Masa perłowa różowa

ARIEL

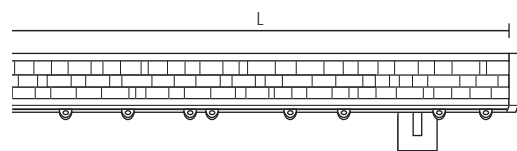

Scorritenda completo a parete
Complete curtain set
Tringle complète pose murale
Komplette Wandgarnitur
Conjunto completo a pared
Karnisz kompletny montaż do ściany

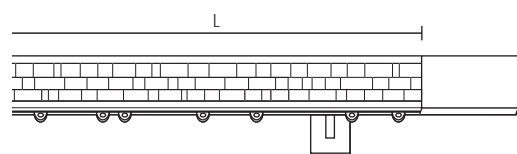

Scorritenda completo a parete
Complete curtain set
Tringle complète pose murale
Komplette Wandgarnitur
Conjunto completo a pared
Karnisz kompletny montaż do ściany

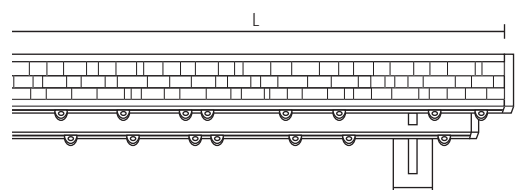

Scorritenda completo doppio a parete
Complete double curtain set
Tringle complète double
Komplette doppelgarnitur
Conjunto completo doble
Karnisz podwójny kompletny montaż do ściany

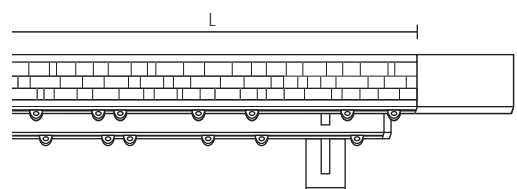

Scorritenda completo doppio a parete
Complete double curtain set
Tringle complète double pose murale
Komplette Doppelgarnitur
Conjunto completo doble a pared
Karnisz podwójny kompletny montaż do ściany

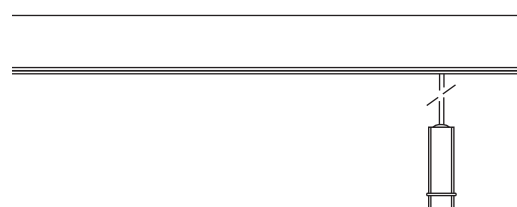

FIN. = Finitura - Finish - Finition - Fertigung - Acabado - Wykonczenie
Scor. = Scorrevoli - Runners - Glisseurs - Gleiter - Correderas - Ślizgacze
Sup. = Supporti - Brackets - Supports - Träger - Soportes - Wsporniki

Cod. 513S02A

FIN	cm	120	140	160	180	200	220	250	300	340
67 MB - MR - MG		705	796	885	974	1.065	1.154	1.355	1.579	1.757
81 MB - MR - MG		661	747	832	916	1.003	1.088	1.276	1.488	1.658
Scor. Cod. 1012	n.	16	20	22	24	28	30	36	42	46
Sup. cm 9	n.	2	2	2	2	2	2	3	3	3

Cod. 513S02C

FIN	cm	120	140	160	180	200	220	250	300	340
67 MB - MR - MG		751	842	931	1.020	1.111	1.200	1.400	1.624	1.803
81 MB - MR - MG		708	794	879	964	1.050	1.135	1.323	1.535	1.705
Scor. Cod. 1012	n.	16	20	22	24	28	30	36	42	46
Sup. cm 9	n.	2	2	2	2	2	2	3	3	3

Cod. 513U02A

FIN	cm	120	140	160	180	200	220	250	300	340
67 MB - MR - MG		802	901	997	1.093	1.193	1.289	1.514	1.756	1.948
81 MB - MR - MG		751	845	936	1.026	1.120	1.210	1.422	1.650	1.831
Scor. Cod. 1012	n.	16/16	20/20	22/22	24/24	28/28	30/30	36/36	42/42	46/46
Sup. cm 8	n.	2	2	2	2	2	2	3	3	3

Cod. 513U02C

FIN	cm	120	140	160	180	200	220	250	300	340
67 MB - MR - MG		847	947	1.043	1.139	1.239	1.335	1.559	1.802	1.994
81 MB - MR - MG		799	892	983	1.073	1.167	1.257	1.470	1.697	1.878
Scor. Cod. 1012	n.	16/16	20/20	22/22	24/24	28/28	30/30	36/36	42/42	46/46
Sup. cm 8	n.	2	2	2	2	2	2	3	3	3

Maggiorazione movimento a corda - Surcharge for corded systems - Supplément pour tirage
Zuschlag für Schnurbedienung - Suplemento por cuerda - Dodatkowo koszt mechanizmu

cm	120	140	160	180	200	220	250	300	340
	72	72	72	72	77	77	77	77	77



ARIEL

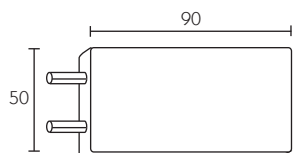

513041C

Terminale
Finial
Embout

Endstück
Terminal
Końcówka

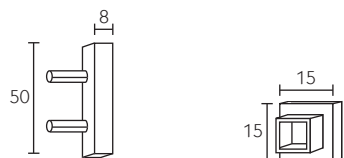

513041A

Terminale
Finial
Embout
Endstück
Terminal
Końcówka

513045

Tappo
Endcap
Bouchon
Endkappe
Tapón
Zatyczka

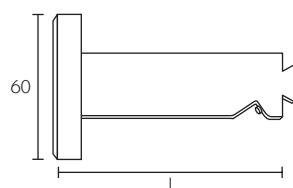

5132--

Supporto
Bracket
Support

Träger
Soporte
Wspornik



40

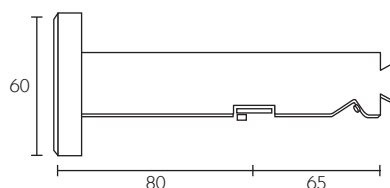

513217

Supporto doppio
Double bracket
Support double

Doppelträger
Soporte doble
Wspornik podwójny

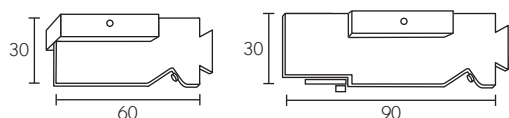

513518

Supporto a soffitto
Ceiling bracket
Support à plafond
Deckenträger
Soporte a techo
Wspornik do sufitu

513517

Supporto doppio a soffitto
Double ceiling bracket
Support à plafond double
Decken-Doppelträger
Soporte doble a techo
Wspornik podwójny do sufitu

Cod.	513041C
FIN	
67	42,20
81	39,60

Cod.	513041A	513045
FIN		
67	19,30	14,20
81	16,00	13,30

Cod.		513218	513228	513238
FIN	l - mm	90	160	210
67		63,90	68,10	75,50
81		58,40	64,10	71,90

Cod.	513217
FIN	
67	75,50
81	71,90

Cod.	513518	513517
FIN		
67	62,80	68,10
81	58,40	64,10

Components

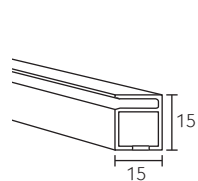

153200
Profilo
Profile
Profil

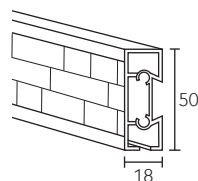

513100
Profil
Perfil
Profil

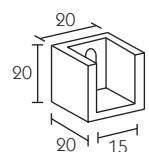

153001
Rosetta a muro
Recess bracket
Naissance murale

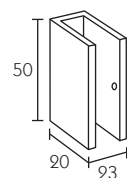

513125
Wandlager
Soporte lateral
Podkładka do muru



1012
Scorrevole
Runner
Glisseur



1065
Gleiter
Corredera
Slizgacze

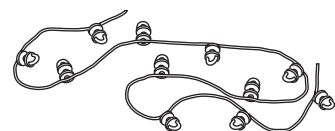

1000--
Scorrevoli
Runners
Glisseurs

Gleiter
Correderas
Slizgacze

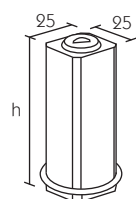

5630--
Fiocco piatto
Flat weight
Contrepoids plat

Schnurbeschwerer
Contrapeso plano
Obciążnik płaski



518081
Fermatenda in madreperla
Mother of pearl holdback
Porte-embrasse patère en nacre
Raffhalter Perlmutter
Alzapaño nácar
Podwiązania z masy perłowej



518082

Cod.		153200	513100
FIN	mm		
67		26,80	
81		20,40	
67 MB - MR - MG			438,20
81 MB - MR - MG			415,80

Cod.		153001SX / DX	513125SX / DX
FIN	mm		
67		22,50	25,50
81		18,40	21,00

Cod.		1012	1065
FIN			
		0,80	0,08

Cod.		1065P6*	1065P8**
FIN			
Euro/mt		6,74	6,74

* Scorrevoli passo 60 mm - Runners each 60 mm - Glisseurs tous les 60 mm - Gleiter je 60 mm - Correderas cada 60 mm - Slizgi co 60 mm
** Scorrevoli passo 80 mm - Runners each 80 mm - Glisseurs tous les 80 mm - Gleiter je 80 mm - Correderas cada 80 mm - Slizgi co 80 mm

Cod.		563007	563008
FIN	h - mm		
67		26,00	31,00
81		22,00	24,50

Cod.		518081	518082
FIN			
131 - 132 - 133 - 134		33,50	33,50
135 - 136 - 137		33,50	33,50



ALUMINIUM COLLECTION



AVE

FINITURE - FINISHES - FINITIONS - FERTIGUNGEN - ACABADOS - WYKOŃCZENIA

25	BNL
	2BNL
	6BNL



AVE



Fin. 67
Alluminio lucido
Bright aluminium
Aluminium poli

Aluminium poliert
Aluminio pulido
Aluminium polerowane



Fin. 2BNL
Laccato bianco - Alluminio colore acciaio satinato
Lacquered white - Anodized aluminium steel color
Blanc laqué - Aluminium anodisé coloris acier
Lackiert Weiss - Aluminium eloxiert - Stahl Farbe
Blanco lacado - Aluminio anodizado color acero
Lakierowane białe - Aluminium w kolorze stali matowe

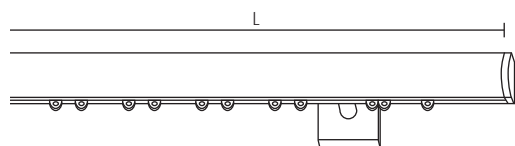

Scorritenda completo a parete
Complete curtain set
Tringle complète pose murale
Komplette Wandgarnitur
Conjunto completo a pared
Karnisz kompletny montaż do ściany

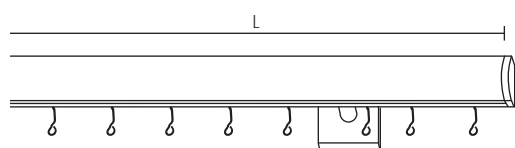

Scorritenda completo a parete
Complete curtain set
Tringle complète pose murale
Komplette Wandgarnitur
Conjunto completo a pared
Karnisz kompletny montaż do ściany

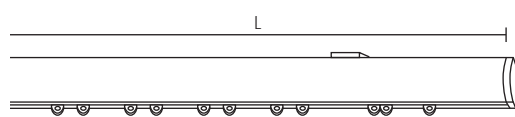

Scorritenda completo a soffitto
Complete curtain set with ceiling bracket
Tringle complète à plafond
Komplette Deckengarnitur
Conjunto completo a techo
Karnisz kompletny do sufitu

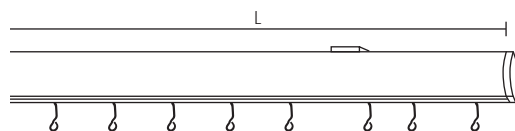

Scorritenda completo a soffitto
Complete curtain set with ceiling bracket
Tringle complète à plafond
Komplette Deckengarnitur
Conjunto completo a techo
Karnisz kompletny do sufitu

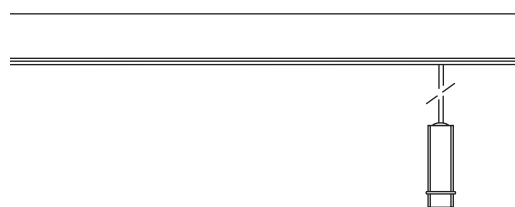

FIN. = Finitura - Finish - Finition - Fertigung - Acabado - Wykonczenie
Scor. = Scorrevoli - Runners - Glisseurs - Gleiter - Correderas - Ślizgacze
Sup. = Supporti - Brackets - Supports - Träger - Soportes - Wsporniki

Cod. 353A01

FIN	cm	120	140	160	180	200	220	250	300	340
25		162	171	180	188	197	241	254	276	293
67		192	201	211	220	230	283	298	321	340
2BNL		162	171	180	188	197	241	254	276	293
6BNL		186	195	204	212	221	273	286	308	325
2BNL - Strass		212	221	230	238	247	291	304	326	343
6BNL - Strass		236	245	254	262	271	323	336	358	375
Scor. Cod. 1000	n.	16	20	22	24	28	30	36	42	46
Sup. cm 16	n.	2	2	2	2	2	3	3	3	3

Cod. 353A02

FIN	cm	120	140	160	180	200	220	250	300	340
25		190	204	217	230	243	293	315	346	372
67		220	234	248	262	276	335	358	391	420
2BNL		190	204	217	230	243	293	315	346	372
6BNL		214	228	241	254	267	325	347	378	404
2BNL - Strass		240	254	267	280	293	343	365	396	422
6BNL - Strass		264	278	291	304	317	375	397	428	454
Scor. Cod. 524057	n.	12	14	16	18	20	22	26	30	34
Sup. cm 16	n.	2	2	2	2	2	3	3	3	3

Cod. 353T01

FIN	cm	120	140	160	180	200	220	250	300	340
25		113	122	131	139	148	168	181	202	219
67		126	136	146	155	165	186	200	224	243
2BNL		113	122	131	139	148	168	181	202	219
6BNL		121	130	138	147	156	176	189	210	227
2BNL - Strass		163	172	181	189	198	218	231	252	269
6BNL - Strass		171	180	188	197	206	226	239	260	277
Scor. Cod. 1000	n.	16	20	22	24	28	30	36	42	46
Sup.	n.	2	2	2	2	2	3	3	3	3

Cod. 353T02

FIN	cm	120	140	160	180	200	220	250	300	340
25		141	155	168	181	194	219	241	272	299
67		154	169	183	197	211	237	260	294	322
2BNL		141	155	168	181	194	219	241	272	299
6BNL		149	162	176	189	202	227	249	280	307
2BNL - Strass		191	205	218	231	244	269	291	322	349
6BNL - Strass		199	212	226	239	252	277	299	330	357
Scor. Cod. 524057	n.	12	14	16	18	20	22	26	30	34
Sup.	n.	2	2	2	2	2	3	3	3	3

Maggiorazione movimento a corda - Surcharge for corded systems - Supplément pour tirage
Zuschlag für Schnurbedienung - Suplemento por cuerda - Dodatkowo koszt mechanizmu

cm	120	140	160	180	200	220	250	300	340
	72	72	72	72	77	77	77	77	77

AVE

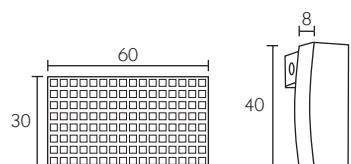

423102
Strass

423101
Tappo
Endcap
Bouchon
Endkappe
Tapón
Zatyczka

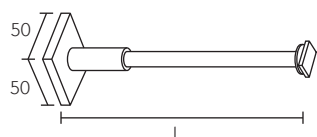

3133--
Supporto
Bracket
Support

Träger
Soporte
Wspornik

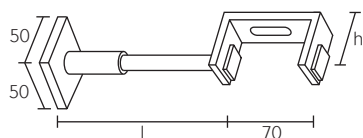

3134--
Supporto doppio
Double bracket
Support double

Doppelträger
Soporte doble
Wspornik podwójny

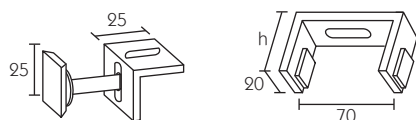

313598
Supporto a soffitto
Ceiling bracket
Support à plafond
Deckenträger
Soporte a techo
Wspornik do sufitu

3135--
Supporto doppio a soffitto
Double ceiling bracket
Support à plafond double
Decken-Doppelträger
Soporte doble a techo
Wspornik podwójny do sufitu

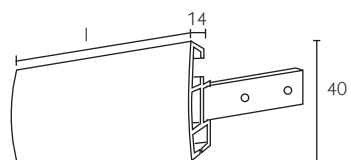

423007
Angolo
Angle
Retour

Kante
Ángulo
Narože

Cod.	423102	423101SX / DX
FIN		
25		19,40
67		23,30
Strass	25,00	

Cod.		313318	313328
FIN	l - mm	160	210
25		35,90	38,40
67		44,00	48,00

Cod.		313437	313447	313417	313427
FIN	h - mm	23	23	35	35
	l - mm	160	210	160	210
25		55,50	58,60	55,50	58,60
67		59,70	62,80	59,70	62,80

Cod.		313598	313587	313597
FIN	h - mm		23	35
25		11,40	20,60	20,60
67		11,40	24,80	24,80

Cod.		423007	423008
FIN	l - mm	160	210
25		50,60	53,10
67		54,90	57,30
BNL		50,60	53,10



Components

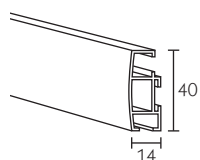

423100
 Profilo
 Profile
 Profil
 Profil
 Perfil
 Profil

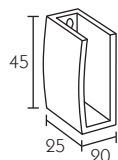

423001
 Rosetta a muro
 Recess bracket
 Naissance murale
 Wandlager
 Soporte lateral
 Podkładka do muru



524057
 Scorrevole
 Runner
 Glisseur



1000 1001
 Gleiter
 Corredera
 Ślizgacze

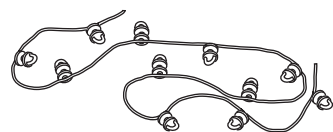

1000--
 Scorrevoli
 Runners
 Glisseurs

Gleiter
 Correderas
 Ślizgacze

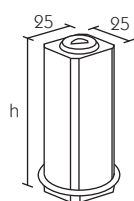

5630--
 Fiocco piatto
 Flat weight
 Contrepoids plat

Schnurbeschwerer
 Contrapeso plano
 Obciążnik płaski

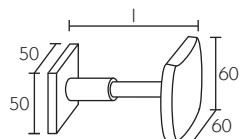

5131--
 Fermatenda
 Holdback
 Porte-embrasse

Raffhalter
 Alzapaño
 Przytrzymanie firanki

Cod.	423100	423001SX / DX
FIN		
25	42,00	28,00
67	46,50	31,00
BNL	42,00	

Cod.	524057	1000	1001
FIN			
25 - 67	2,44	0,08	0,61

Cod.	1000P6*	1000P8**
FIN		
Euro/mt	6,74	6,74

* Scorrevoli passo 60 mm - Runners each 60 mm - Glisseurs tous les 60 mm - Gleiter je 60 mm - Correderas cada 60 mm - Ślizgi co 60 mm
 ** Scorrevoli passo 80 mm - Runners each 80 mm - Glisseurs tous les 80 mm - Gleiter je 80 mm - Correderas cada 80 mm - Ślizgi co 80 mm

Cod.	563007	563008
FIN	h - mm	100
25	23,50	26,00
67	26,00	31,00

Cod.	513101	513102	513103
FIN	l - mm	150	200
25	53,00	57,00	61,00
67	58,30	62,80	67,30
BNL	58,30	62,80	67,30



ALUMINIUM COLLECTION



48

CARLA

FINITURE - FINISHES - FINITIONS - FERTIGUNGEN - ACABADOS - WYKOŃCZENIA

25 A

67 B

R

W



CARLA

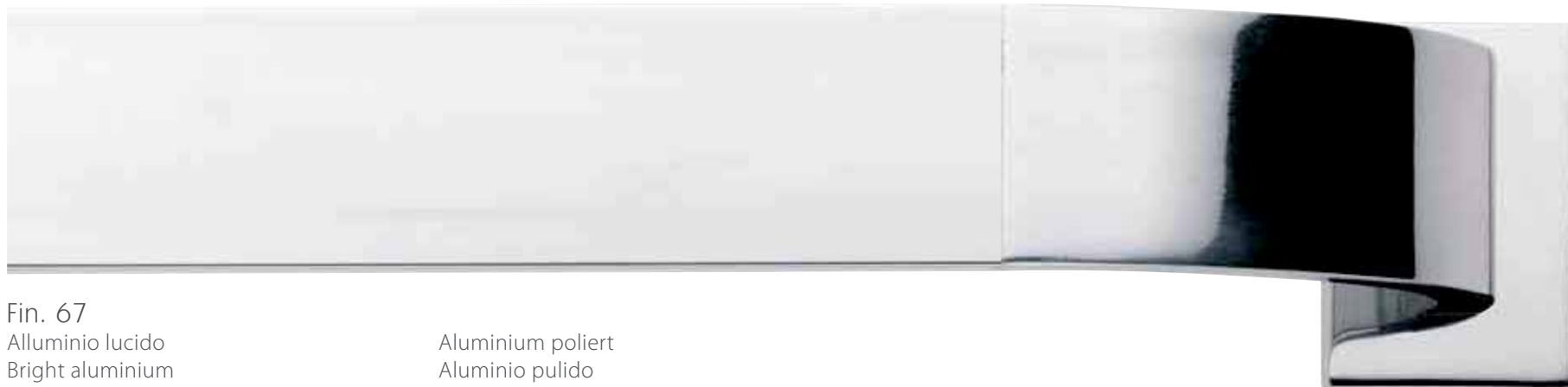

Fin. 67
Alluminio lucido
Bright aluminium
Aluminium poli

Aluminium poliert
Aluminio pulido
Aluminium polerowane



Fin. 25W
Alluminio colore acciaio satinato - Wengé
Anodized aluminium steel color - Wengé
Aluminium anodisé coloris acier - Wengé

Aluminium eloxiert Stahl Farbe - Wengé
Aluminio anodizado color acero - Wengé
Aluminium w kolorze stali matowe - Wengé



Fin. A



Fin. B

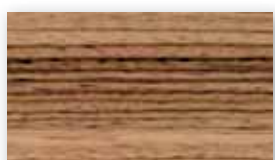

Fin. R

CARLA

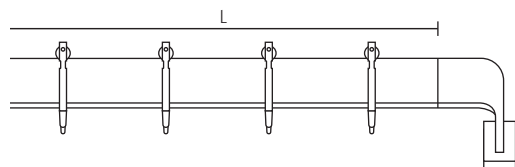

Scorritenda completo a parete
Complete curtain set
Tringle complète pose murale
Komplette Wandgarnitur
Conjunto completo a pared
Karnisz kompletny montaż do ściany

FIN. = Finitura - Finish - Finition - Fertigung - Acabado - Wykonczenie
An. = Anelli - Rings - Anneaux - Ringe - Anillas - Kółka
Sup. = Supporti - Brackets - Supports - Träger - Soportes - Wsporniki

Cod. 413A08

FIN	cm	120	140	160	180	200	220	250	300	340
25		270	289	308	327	346	365	455	497	535
67		290	310	330	350	370	390	487	532	572
25 A - B - R - W		325	353	381	409	437	466	569	634	690
67 A - B - R - W		338	367	395	423	451	479	588	653	710
An.	n.	16	18	20	22	24	26	30	34	38
Sup. cm 9	n.	2	2	2	2	2	2	3	3	3

Cod. 413B08

FIN	cm	120	140	160	180	200	220	250	300	340
25		287	306	325	344	363	382	477	519	557
67		307	327	347	367	387	407	510	554	594
25 A - B - R - W		342	370	398	426	454	482	591	656	712
67 A - B - R - W		356	384	412	440	468	496	611	676	732
An.	n.	18	20	22	24	26	28	32	36	40
Sup. cm 16	n.	2	2	2	2	2	2	3	3	3

Cod. 413E08

FIN	cm	120	140	160	180	200	220	250	300	340
25		304	323	342	361	380	399	500	542	580
67		324	344	365	385	405	425	534	579	619
25 A - B - R - W		358	387	415	443	471	499	614	679	736
67 A - B - R - W		373	401	429	457	486	514	636	701	757
An.	n.	20	22	24	26	28	30	34	38	42
Sup. cm 22	n.	2	2	2	2	2	2	3	3	3

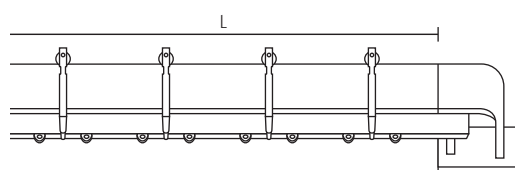

Scorritenda completo doppio a parete
Complete double curtain set
Tringle complète double pose murale
Komplette Doppelgarnitur
Conjunto completo doble a pared
Karnisz podwójny kompletny montaż do ściany

Cod. 413C08

FIN	cm	120	140	160	180	200	220	250	300	340
25		377	404	430	455	482	508	621	680	731
67		404	432	459	486	515	542	664	727	781
25 A - B - R - W		432	468	503	537	574	608	735	817	887
67 A - B - R - W		452	489	524	559	596	631	766	849	919
An.	n.	16/16	18/20	20/22	22/24	24/28	26/30	30/36	34/42	38/46
Sup. cm 9	n.	2	2	2	2	2	2	3	3	3



CARLA

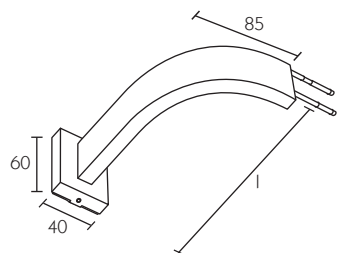

4133--

Supporto
Bracket
Support

Träger
Soporte
Wspornik

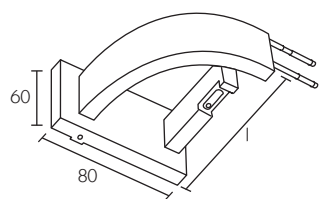

4133--

Supporto doppio
Double bracket
Support double

Doppelträger
Soporte doble
Wspornik podwójny

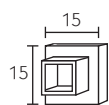

513045

Tappo
Endcap
Bouchon

Endkappe
Tapón
Zatyczka



52

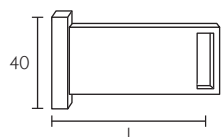

4133--

Supporto intermedio
Central bracket
Support intermédiaire

Mittelträger
Soporte intermedio
Wspornik środkowy

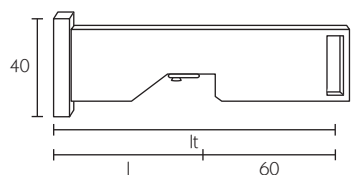

4133--

Supporto intermedio doppio
Central double bracket
Support intermédiaire double
Mitteldoppelträger
Soporte intermedio doble
Wspornik środkowy podwójny

Cod.		413308SX / DX	413318SX / DX	413328SX / DX
FIN	l - mm	90	160	220
25		67,40	70,50	73,60
67		74,20	77,50	80,90

Cod.		413317SX / DX	413327SX / DX
FIN	l - mm	160	210
25		85,90	91,90
67		94,40	101,10

Cod.		513045
FIN		
25		14,20
67		14,20

Cod.		413309	413319	413329
FIN	l - mm	90	160	220
25		56,10	60,90	67,70
67		61,70	67,00	74,40

Cod.		413339	413349
FIN	l - mm	90	160
	lt - mm	160	230
25		67,70	73,70
67		74,40	81,10

Components

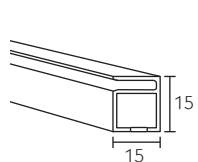

153200
 Profilo
 Profile
 Profil

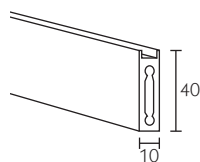

413200
 Profil
 Perfil
 Profil

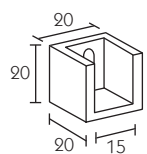

153001
 Rosetta a muro
 Recess bracket
 Naissance murale

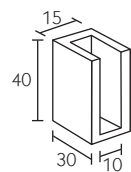

413001
 Wandlager
 Soporte lateral
 Podkładka do muru

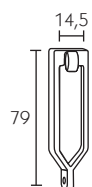

523055
 Anello graffetta
 Clip ring
 Anneau agrafe
 Klammer Ring
 Anilla clip
 Kółko klamra



1012
 Scorrevole
 Runnere
 Glisseure
 Gleiter
 Corredera
 Slizgacze

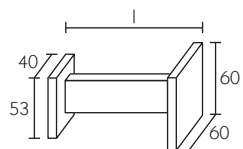

5130--
 Fermatenda
 Holdback
 Porte-embrasse



Raffhalter
 Alzapaño
 Przytrzymanie firanki

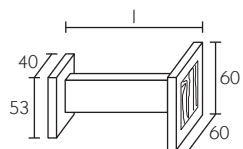

5130--
 Fermatenda
 Holdback
 Porte-embrasse



Raffhalter
 Alzapaño
 Przytrzymanie firanki

Cod.	153200	413200
FIN		
25	24,20	42,00
67	26,80	47,20
A - B - R - W		87,70

Cod.	153001SX / DX	413001SX / DX
FIN		
25	20,40	33,00
67	22,50	37,60

Cod.	523055	1012
FIN		
25	5,30	
67	5,30	0,80

Cod.	513031	513032	513033
FIN	l - mm	150	200
25		81,70	86,70
67		89,90	95,50

Cod.	513094	513095	513096
FIN	l - mm	150	200
25 A - B - R - W		95,70	100,70
67 A - B - R - W		103,90	109,50



ALUMINIUM COLLECTION



54

CARMEN

FINITURE - FINISHES - FINITIONS - FERTIGUNGEN - ACABADOS - WYKOŃCZENIA

25	BNL	A1	A125	A167	A	BB	CB	SB
67	2BNL	A2	A225	A267	B	BC	CC	SC
99	6BNL	A3	A325	A367	W	BM	CM	SM
		A4	A425	A467		BN	CN	SN
						BR	CR	SR



CARMEN

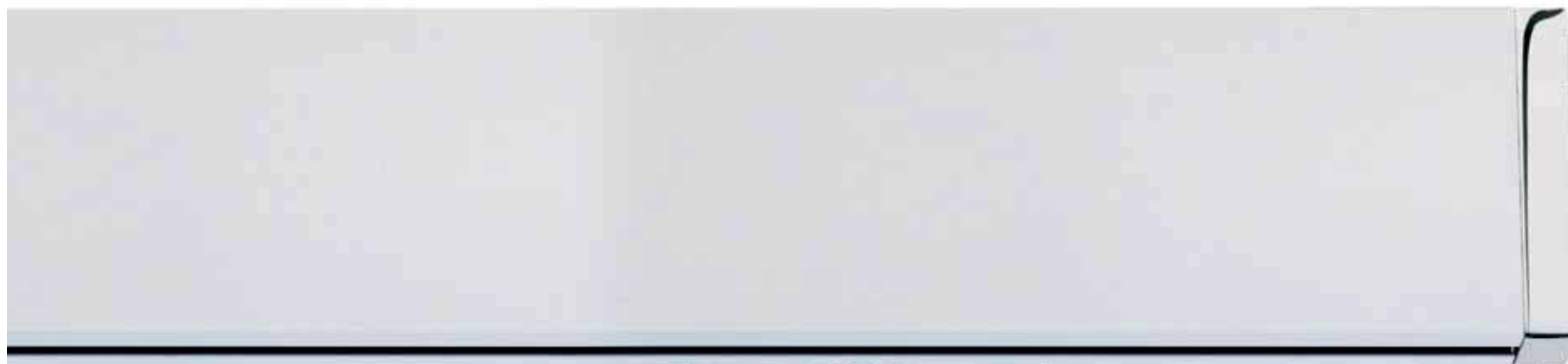

Fin. 6BNL

Laccato bianco - Alluminio lucido
Lacquered white - Bright aluminium
Blanc laqué - Aluminium poli
Lackiert Weiss - Poliertes Aluminium
Blanco lacado - Aluminio pulido
Lakierowane białe - Aluminium polerowane



Fin. 25A

Alluminio colore acciaio satinato - Ciliegio
Anodized aluminium Steel color - Cherry
Aluminium anodisé coloris acier - Merisier
Aluminium eloxiert Stahl Farbe - Kirschbaum
Aluminio anodizado color acero - Cerezo
Aluminium w kolorze stali matowej - Wiśnia

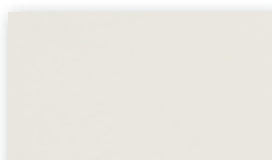

Fin. A1

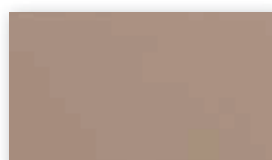

Fin. A2

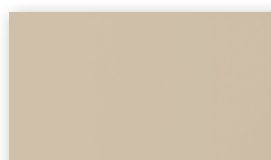

Fin. A3

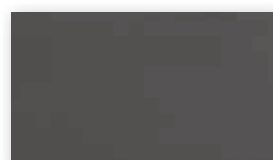

Fin. A4



Fin. B



Fin. W

H 1:1

CARMEN

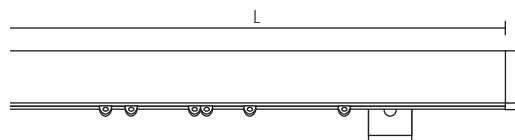

Scorritenda completo a parete
Complete curtain set
Tringle complète pose murale
Komplette Wandgarnitur
Conjunto completo a pared
Karnisz kompletny montaż do ściany

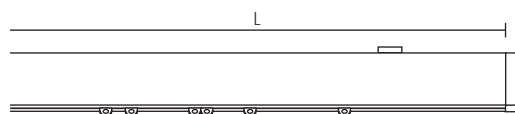

Scorritenda completo a soffitto
Complete curtain set with ceiling bracket
Tringle complète à plafond
Komplette Deckengarnitur
Conjunto completo a techo
Karnisz kompletny do sufitu

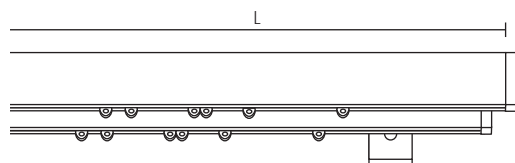

Scorritenda completo doppio a parete
Complete double curtain set
Tringle complète double pose murale
Komplette Doppelgarnitur
Conjunto completo doble a pared
Karnisz podwójny kompletny montaż do ściany

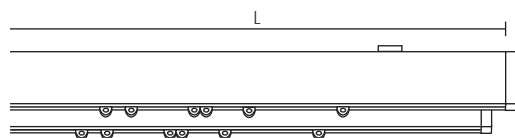

Scorritenda completo doppio a soffitto
Complete double curtain set with ceiling bracket
Tringle complète double à plafond
Komplette Decken-Doppelgarnitur
Conjunto completo doble a techo
Karnisz kompletny podwójny do sufitu

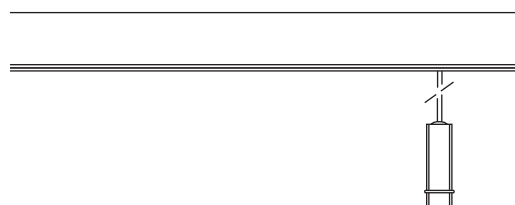

FIN. = Finitura - Finish - Finition - Fertigung - Acabado - Wykonczenie
Scor. = Scorrevoli - Runners - Glisseurs - Gleiter - Correderas - Ślizgacze
Sup. = Supporti - Brackets - Supports - Träger - Soportes - Wsporniki

Cod. 513A41

FIN	cm	120	140	160	180	200	220	250	300	340
25		169	177	186	195	203	253	266	287	304
67 - 6BNL		186	196	206	215	225	279	294	318	337
99		226	237	248	259	271	335	352	380	402
25 A - B - W		161	169	176	184	191	240	251	269	284
67 A - B - W		173	181	188	195	203	255	266	285	300
2BNL		175	184	194	204	213	264	278	302	321
A125 - A225 - A325 - A425		169	177	186	195	203	253	266	287	304
A167 - A267 - A367 - A467		180	189	198	206	215	268	281	303	320
Scor. Cod. 1000	n.	16	20	22	24	28	30	36	42	46
Sup. cm 16	n.	2	2	2	2	2	3	3	3	3

Cod. 513T41

FIN	cm	120	140	160	180	200	220	250	300	340
25		109	118	127	135	144	164	177	199	216
67 - 6BNL		119	129	138	148	158	179	193	217	236
99		142	153	165	176	187	209	226	254	276
25 A - B - W		102	110	117	125	132	151	162	181	195
67 A - B - W		106	113	121	128	136	154	166	184	199
2BNL		115	125	135	144	154	175	190	214	233
A125 - A225 - A325 - A425		109	118	127	135	144	164	177	199	216
A167 - A267 - A367 - A467		113	122	130	139	148	168	181	202	219
Scor. Cod. 1000	n.	16	20	22	24	28	30	36	42	46
Sup.	n.	2	2	2	2	2	3	3	3	3

Cod. 513X41

FIN	cm	120	140	160	180	200	220	250	300	340
25		284	302	319	336	353	426	452	495	529
67 - 6BNL		312	331	351	370	389	468	497	545	583
99		383	405	427	450	472	566	600	656	700
25 A - B - W		270	285	300	314	329	400	422	459	489
67 A - B - W		286	301	315	330	345	420	442	479	508
2BNL		296	316	335	354	373	448	477	525	563
A125 - A225 - A325 - A425		284	302	319	336	353	426	452	495	529
A167 - A267 - A367 - A467		300	317	335	352	369	446	472	515	549
Scor. Cod. 1000	n.	16/16	20/20	22/22	24/24	28/28	30/30	36/36	42/42	46/46
Sup. cm 16	n.	2	2	2	2	2	3	3	3	3

Cod. 513Y41

FIN	cm	120	140	160	180	200	220	250	300	340
25		215	232	249	266	284	321	348	391	425
67 - 6BNL		238	257	277	296	315	357	386	434	472
99		293	315	337	360	382	431	465	521	565
25 A - B - W		200	215	230	245	260	295	318	355	384
67 A - B - W		212	227	241	256	271	309	331	368	397
2BNL		227	246	265	284	304	343	373	421	459
A125 - A225 - A325 - A425		215	232	249	266	284	321	348	391	425
A167 - A267 - A367 - A467		226	243	261	278	295	335	361	404	438
Scor. Cod. 1000	n.	16/16	20/20	22/22	24/24	28/28	30/30	36/36	42/42	46/46
Sup.	n.	2	2	2	2	2	3	3	3	3

Maggiorazione movimento a corda - Surcharge for corded systems - Supplément pour tirage
Zuschlag für Schnurbedienung - Suplemento por cuerda - Dodatkowo koszt mechanizmu

cm	120	140	160	180	200	220	250	300	340
	72	72	72	72	77	77	77	77	77



CARMEN

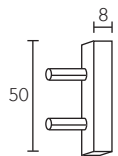

513041A

Terminale
Finial
Embout

Endstück
Terminal
Końcówka

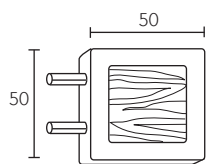

513025

Terminale
Finial
Embout

Endstück
Terminal
Końcówka

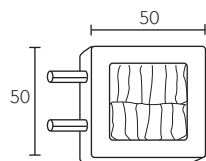

513072

Terminale
Finial
Embout

Endstück
Terminal
Końcówka



58

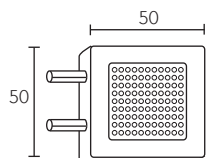

513089

Terminale
Finial
Embout

Endstück
Terminal
Końcówka

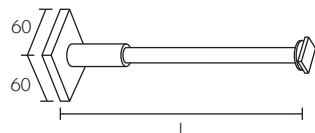

5133--

Supporto
Bracket
Support

Träger
Soporte
Wspornik

Cod.	513041A	
FIN		
25		17,50
67		19,30
99		26,30
BNL		19,30

Cod.	513025	
FIN		
25 wood		38,00
67 wood		41,80
99 wood		57,00
BNL wood		41,80

Cod.	513072	
FIN		
25 sky		38,00
67 sky		41,80
99 sky		57,00
BNL sky		41,80

Cod.	513089	
FIN		
25 strass		41,00
67 strass		45,00
99 strass		60,00
BNL strass		45,00

Cod.		513318	513328
FIN	I - mm	160	210
25		41,00	45,00
67		45,00	49,50
99		53,30	58,50
BNL		45,00	49,50

Components

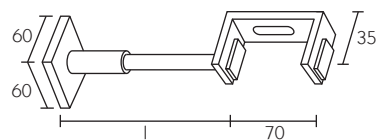

5134-

Supporto doppio
Double bracket
Support double

Doppelträger
Soporte doble
Wspornik podwójny

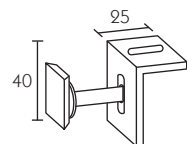

513598

Supporto a soffitto
Ceiling bracket
Support à plafond

Deckenträger
Soporte a techo
Wspornik do sufitu

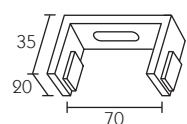

513597

Supporto doppio a soffitto
Double ceiling bracket
Support à plafond double
Decken-Doppelträger
Soporte doble a techo
Wspornik podwójny do sufitu

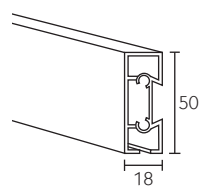

513100

Profilo
Profile
Profil

Profil
Perfil
Profil

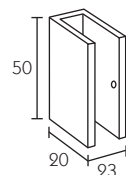

513125

Rosetta a muro
Recess bracket
Naissance murale

Wandlager
Soporte lateral
Podkładka do muru

Cod.		513417	513427
FIN	l - mm	160	210
25		55,50	58,60
67		59,70	62,80
99		72,00	76,00
BNL		59,70	62,80

Cod.		513598
FIN		
25		11,40
67		11,40
99		11,40
BNL		11,40

Cod.		513597
FIN		
25		20,60
67		22,70
99		27,00
BNL		22,70

Cod.		513100
FIN		
25		42,00
67		47,00
99		54,60
A - B - W		36,00
BNL		47,00
A1 - A2 - A3 - A4		42,00

Cod.		513125SX / DX
FIN		
25		23,00
67		25,50
99		30,00
BNL		25,50



CARMEN

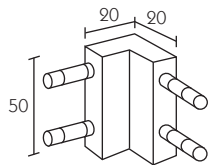

513312

Angolare
Angle
Angle

Ecke
Ángulo
Narozny



1000

Scorrevole
Runner
Glisseur



1001

Gleiter
Corredera
Slizgacze

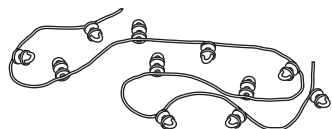

1000--

Scorrevoli
Runners
Glisseurs

Gleiter
Correderas
Slizgacze



60

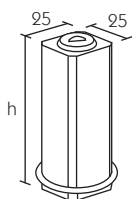

5630--

Fiocco piatto
Flat weight
Contrepoids plat

Schnurbeschwerer
Contrapeso plano
Obciążnik płaski

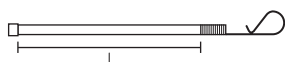

5630--

Frusta
Wand
Lance - rideau

Schleuderstab
Tirador
Bicze

Cod.	513312
FIN	
25	35,00
67	38,50
99	45,00
BNL	38,50

Cod.	1000	1001
FIN		
	0,08	0,61

Cod.	1000P6*	1000P8**
FIN		
Euro/mt	6,74	6,74

* Scorrevoli passo 60 mm - Runners each 60 mm - Glisseurs tous les 60 mm - Gleiter je 60 mm - Correderas cada 60 mm - Ślizgi co 60 mm
** Scorrevoli passo 80 mm - Runners each 80 mm - Glisseurs tous les 80 mm - Gleiter je 80 mm - Correderas cada 80 mm - Ślizgi co 80 mm

Cod.		563007	563008
FIN	h - mm	80	100
25		23,50	26,00
67		26,00	31,00
99		35,30	39,00
BNL		26,00	31,00

Cod.		563010	563011	563012
FIN	l - mm	100	125	150
25		35,00	39,00	43,00
67		39,00	43,00	47,00
99		45,50	49,50	53,50
BNL		39,00	43,00	47,00

Components

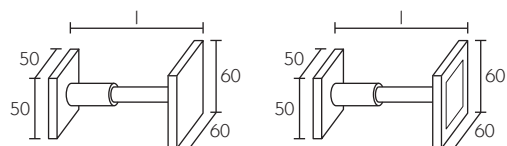

5130--
Fermatenda
Holdback
Porte-embrasse

Raffhalter
Alzapaño
Przytrzymanie firanki

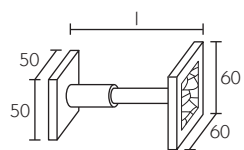

5130--
Fermatenda
Holdback
Porte-embrasse

Raffhalter
Alzapaño
Przytrzymanie firanki

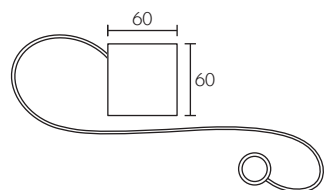

513080
Fermatenda
Holdback
Porte-embrasse

Raffhalter
Alzapaño
Przytrzymanie firanki

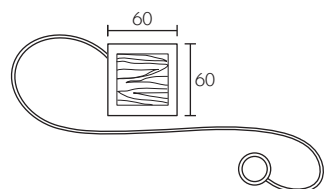

513090
Fermatenda
Holdback
Porte-embrasse

Raffhalter
Alzapaño
Przytrzymanie firanki

Cod.		513091	513092	513093
FIN	l - mm	100	150	200
25		53,00	57,00	61,00
67		58,30	62,80	67,30
99		79,50	84,70	89,90
BNL		58,30	62,80	67,30
A125 - A225 - A325 - A425		58,30	62,80	67,30
A167 - A267 - A367 - A467		58,30	62,80	67,30

Cod.		513081	513082	513083
FIN	l - mm	100	150	200
25 + sky		65,00	69,00	73,00
25 + wood		67,00	71,00	75,00
25 + strass		78,00	82,00	86,00
67 + sky		70,30	74,80	79,30
67 + wood		72,30	76,80	81,30
67 + strass		83,30	87,80	92,30
99 + sky		91,50	96,70	101,90
99 + wood		93,50	98,70	103,90
99 + strass		104,50	109,70	114,90
BNL + sky		70,30	74,80	79,30
BNL + wood		72,30	76,80	81,30
BNL + strass		83,30	87,80	92,30

Cod.		513080
FIN		
25		38,00
67		41,80
99		45,60
BNL		41,80

Cod.		513090
FIN		
25 + sky		50,00
25 + wood		52,00
25 + strass		63,00
67 + sky		53,80
67 + wood		55,80
67 + strass		66,80
99 + sky		57,60
99 + wood		59,60
99 + strass		70,60
BNL + sky		53,80
BNL + wood		55,80
BNL + strass		66,80



ALUMINIUM COLLECTION



CECILIA

FINITURE - FINISHES - FINITIONS - FERTIGUNGEN - ACABADOS - WYKOŃCZENIA

67	CB	IB	LC	SP
81	CN	IN		
89	CR	IR		



CECILIA



Fin. 67

Alluminio lucido
Bright aluminium
Aluminium poli

Aluminium poliert
Aluminio pulido
Aluminium polerowane



Fin. 67LC

Alluminio lucido - Lucertola
Bright aluminium - Lizard
Aluminium poli - Lézarid

Aluminium poliert - Eidechse
Aluminio pulido - Lagartija
Aluminium polerowane - Jaszczurka

CECILIA

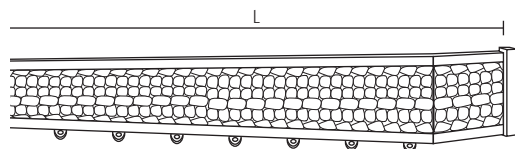

Scorritenda completo a parete
Complete curtain set
Tringle complète pose murale
Komplette Wandgarnitur
Conjunto completo a pared
Karnisz kompletny montaż do ściany

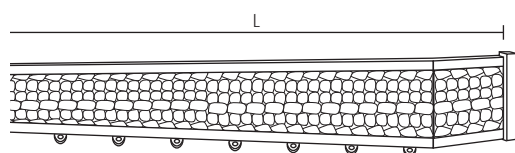

Scorritenda completo con sistema illuminante
Complete curtain set with lighting system
Tringle complète avec système d'éclairage
Komplette Garnitur mit Beleuchtung
Conjunto completo con sistema de iluminación
Karnisz kompletny z oświetleniem system

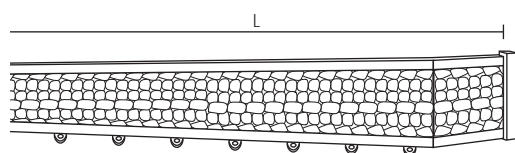

Scorritenda completo doppio a parete
Complete double curtain set
Tringle complète double pose murale
Komplette Doppelgarnitur
Conjunto completo doble a pared
Karnisz podwójny kompletny montaż do ściany

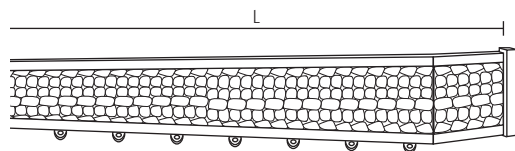

Scorritenda completo doppio con sistema illuminante
Complete double curtain set with lighting system
Tringle complète double avec système d'éclairage
Komplette doppelgarnitur mit Beleuchtung
Conjunto completo doble con sistema de iluminación
Karnisz kompletny podwójny z oświetleniem system

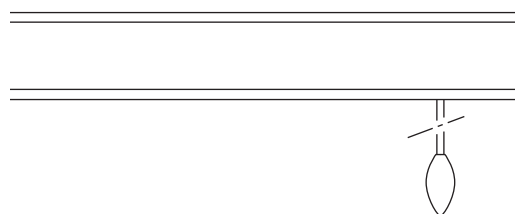

FIN. = Finitura - Finish - Finition - Fertigung - Acabado - Wykonczenie
Scor. = Scorrevoli - Runners - Glisseurs - Gleiter - Correderas - Ślizgacze
Sup. = Supporti - Brackets - Supports - Träger - Soportes - Wsporniki

Cod. 853A05

FIN	cm	160	180	200	220	250	300	340
67		569	595	622	649	730	797	850
81		513	537	561	585	663	723	771
67 CB - CN - CR - IB - IN - IR - LC - SP		618	650	683	715	805	886	950
81 CB - CN - CR - IB - IN - IR - LC - SP		568	598	629	659	746	822	882
Scor.	n.	20	22	26	28	32	38	42
Sup. cm 9	n.	2	2	2	2	3	3	3

Cod. 853L05

FIN	cm	Lux	160	180	200	220	250	300	340
67			2.010	2.095	2.163	2.249	2.619	2.820	2.983
81			1.954	2.037	2.102	2.185	2.552	2.746	2.904
67 CB - CN - CR - IB - IN - IR - LC - SP			2.059	2.150	2.224	2.315	2.694	2.909	3.083
81 CB - CN - CR - IB - IN - IR - LC - SP			2.009	2.098	2.170	2.259	2.635	2.845	3.015
Scor.	n.		20	22	26	28	32	38	42
Sup. cm 9	n.		2	2	2	2	3	3	3

Cod. 853C05

FIN	cm	160	180	200	220	250	300	340
67		650	680	709	739	828	902	961
81		588	615	642	669	754	821	875
67 CB - CN - CR - IB - IN - IR - LC - SP		711	746	781	817	914	1.002	1.073
81 CB - CN - CR - IB - IN - IR - LC - SP		654	687	721	754	848	931	998
Scor.	n.	20/20	22/22	26/26	28/28	32/32	38/38	42/42
Sup. cm 16	n.	2	2	2	2	3	3	3

Cod. 853N05

FIN	cm	Lux	160	180	200	220	250	300	340
67			2.091	2.180	2.250	2.339	2.717	2.925	3.094
81			2.029	2.115	2.183	2.269	2.643	2.844	3.008
67 CB - CN - CR - IB - IN - IR - LC - SP			2.152	2.246	2.322	2.417	2.803	3.025	3.206
81 CB - CN - CR - IB - IN - IR - LC - SP			2.095	2.187	2.262	2.354	2.737	2.954	3.131
Scor.	n.		20/20	22/22	26/26	28/28	32/32	38/38	42/42
Sup. cm 16	n.		2	2	2	2	3	3	3

Maggiorazione movimento a corda - Surcharge for corded systems - Supplément pour tirage
Zuschlag für Schnurbedienung - Suplemento por cuerda - Dodatkowo koszt mechanizmu

cm	160	180	200	220	250	300	340
	72	72	77	77	77	77	77



CECILIA

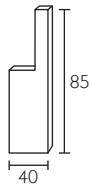

855045

Tappo
Endcap
Bouchon

Endkappe
Tapón
Zatyczka

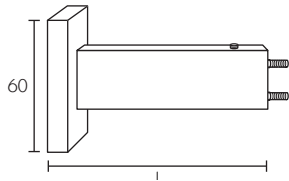

8531--

Supporto
Bracket
Support

Träger
Soporte
Wspornik

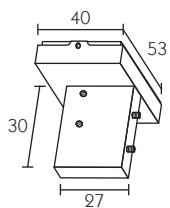

853999

Supporto a soffitto
Ceiling bracket
Support à plafond

Deckenträger
Soporte a techo
Wspornik do sufitu

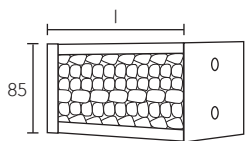

8530--

Angolare 1 via
1 way angle
Retour 1 voie
1-läufige Retoure
Ángulo 1 vía
Kątowy 1 bieg

853065 853075

Angolare 2 vie
2 ways angle
Retour 2 voies
2-läufige Retoure
Ángulo 2 vías
Kątowy 2 biegi

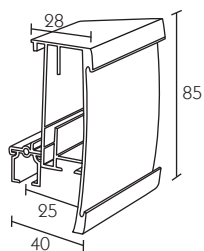

853100

Profilo 1 via
1 way profile
Profil 1 voie

1-läufiges Profil
Perfil 1 vía
Profil 1 bieg

Cod.	855045SX /DX
FIN	
67	36,00
81	29,20

Cod.		853109	853119	853129
FIN	l - mm	90	160	210
89		41,40	44,70	48,10

Cod.	853999
FIN	
89	41,40

Cod.		853035	853045	853055	853065	853075
FIN	l - mm	90	160	210	180	230
67		84,30	96,60	110,10	110,10	125,90
81		78,70	90,00	101,10	101,10	116,90
67 CB - CN - CR - IB - IN - IR - LC - SP		86,50	102,30	118,00	118,00	133,70
81 CB - CN - CR - IB - IN - IR - LC - SP		80,90	95,50	109,00	109,00	124,70

Cod.	853100
FIN	
67	132,60
81	119,10
67 CB - CN - CR - IB - IN - IR - LC - SP	160,70
81 CB - CN - CR - IB - IN - IR - LC - SP	150,60



Components

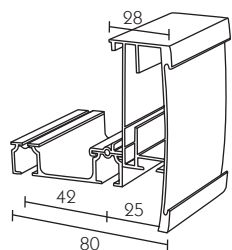

853110

Profilo 2 vie
2 ways profile
Profil 2 voies

2-läufiges Profil
Perfil 2 vías
Profil 2 biegi

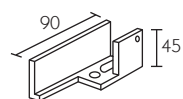

853101

Rosetta a muro
Recess bracket
Naissance murale

Wandlager
Soporte lateral
Podkładka do muru



1000

Scorrevole
Runner
Glisseur



1001

Gleiter
Corredera
Slizgacze

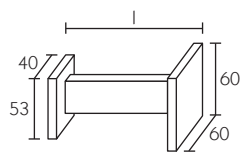

5130--

Fermatenda
Holdback
Porte-embrasse

Raffhalter
Alzapaño
Przytrzymanie firanki

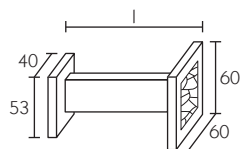

5130--

Fermatenda
Holdback
Porte-embrasse

Raffhalter
Alzapaño
Przytrzymanie firanki

Cod.	853110
FIN	
67	146,10
81	132,60
67 CB - CN - CR - IB - IN - IR - LC - SP	174,20
81 CB - CN - CR - IB - IN - IR - LC - SP	164,10

Cod.	853101SX / DX
FIN	
67	51,70
81	40,50

Cod.	1000	1001
FIN		
	0,08	0,61

Cod.	513031	513032	513033
FIN	100	150	200
67	84,30	89,90	95,50
81	69,00	73,50	78,00

Cod.	513094	513095	513096
FIN	100	150	200
67 CB - CN - CR - IB - IN - IR - LC - SP	96,30	101,90	107,50
81 CB - CN - CR - IB - IN - IR - LC - SP	81,00	85,50	90,00



ALUMINIUM COLLECTION



CHIARA

FINITURE - FINISHES - FINITIONS - FERTIGUNGEN - ACABADOS - WYKOŃCZENIA

25	925	BNL	A1	A125	A167
67	967	2BNL	A2	A225	A267
		6BNL	A3	A325	A367
			A4	A425	A467



CHIARA

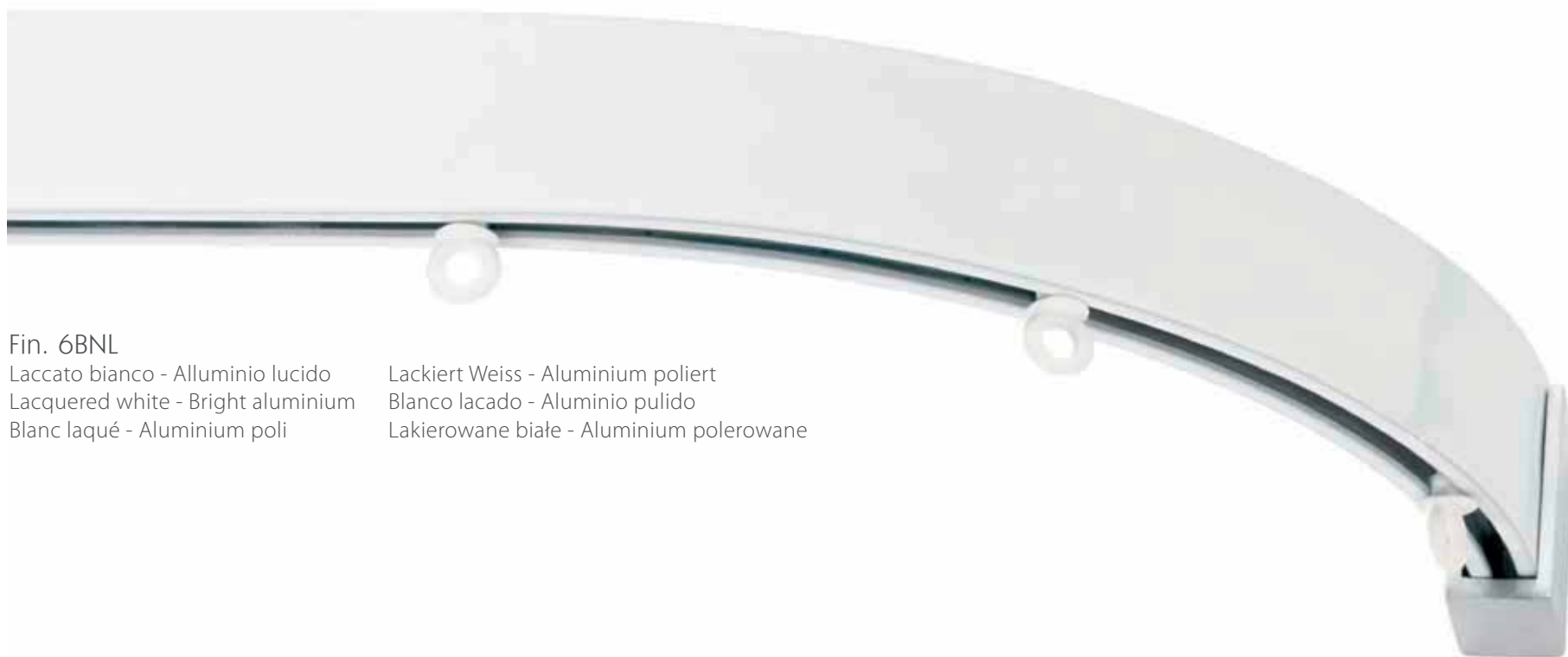

Fin. 6BNL

Laccato bianco - Alluminio lucido
Lacquered white - Bright aluminium
Blanc laqué - Aluminium poli

Lackiert Weiss - Aluminium poliert
Blanco lacado - Aluminio pulido
Lakierowane białe - Aluminium polerowane



Fin. 25

Alluminio colore acciaio satinato
Anodized aluminium steel color
Aluminium anodisé coloris acier

Aluminium eloxiert Stahl Farbe
Aluminio anodizado color acero
Aluminium w kolorze stali matowe

CHIARA

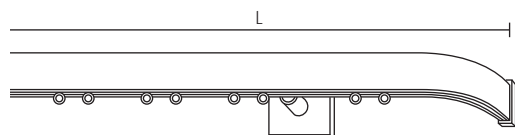

Scorritenda completo a parete
Complete curtain set
Tringle complète pose murale
Komplette Wandgarnitur
Conjunto completo a pared
Karnisz kompletny montaż do ściany

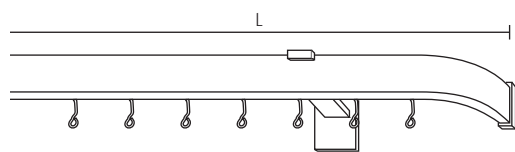

Scorritenda completo a parete
Complete curtain set
Tringle complète
Komplette Garnitur
Conjunto completo
Karnisz kompletny montaż do ściany

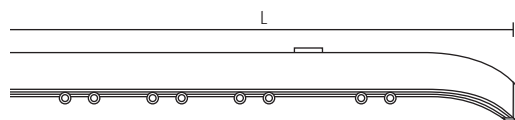

Scorritenda completo a soffitto
Complete curtain set with ceiling bracket
Tringle complète à plafond
Komplette Deckengarnitur
Conjunto completo a techo
Karnisz kompletny do sufitu

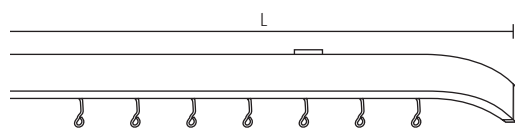

Scorritenda completo a soffitto
Complete curtain set with ceiling bracket
Tringle complète à plafond
Komplette Deckengarnitur
Conjunto completo a techo
Karnisz kompletny do sufitu

FIN. = Finitura - Finish - Finition - Fertigung - Acabado - Wykonczenie
Scor. = Scorrevoli - Runners - Glisseurs - Gleiter - Correderas - Ślizgacze
Sup. = Supporti - Brackets - Supports - Träger - Soportes - Wsporniki

Cod. 353A55

FIN	cm	120	140	160	180	200	220	250	300	340
25		257	263	270	276	282	289	334	350	363
67		281	289	296	304	312	319	375	394	409
925		257	263	270	276	282	289	334	350	363
967		273	280	286	292	299	305	359	374	387
2BNL		265	273	280	288	296	303	351	370	385
6BNL		281	289	296	304	312	319	375	394	409
A125 - A225 - A325 - A425		257	263	270	276	282	289	334	350	363
A167 - A267 - A367 - A467		273	280	286	292	299	305	359	374	387
Scor. Cod. 1065	n.	16	20	22	24	28	30	36	42	46
Sup. cm 11	n.	2	2	2	2	2	2	3	3	3

Cod. 353A45

FIN	cm	120	140	160	180	200	220	250	300	340
25		307	318	329	340	351	362	428	453	475
67		344	356	368	380	393	405	487	516	540
925		307	318	329	340	351	362	428	453	475
967		336	347	358	369	380	391	471	496	518
2BNL		315	327	340	352	364	377	445	473	498
6BNL		344	356	368	380	393	405	487	516	540
A125 - A225 - A325 - A425		307	318	329	340	351	362	428	453	475
A167 - A267 - A367 - A467		336	347	358	369	380	391	471	496	518
Scor. Cod. 524057	n.	12	14	16	18	20	22	26	30	34
Sup. cm 11	n.	2	2	2	2	2	2	3	3	3

Cod. 353T55

FIN	cm	120	140	160	180	200	220	250	300	340
25		202	208	215	221	227	234	255	271	283
67		218	226	233	241	249	256	279	299	314
925		202	208	215	221	227	234	255	271	283
967		210	217	223	229	236	242	263	279	291
2BNL		210	218	225	233	241	248	271	290	306
6BNL		218	226	233	241	249	256	279	299	314
A125 - A225 - A325 - A425		202	208	215	221	227	234	255	271	283
A167 - A267 - A367 - A467		210	217	223	229	236	242	263	279	291
Scor. Cod. 1065	n.	16	20	22	24	28	30	36	42	46
Sup. Cod. 313598	n.	4	4	4	4	4	4	5	5	5

Cod. 353T45

FIN	cm	120	140	160	180	200	220	250	300	340
25		242	253	264	275	286	297	330	355	377
67		263	276	288	300	313	325	362	390	415
925		242	253	264	275	286	297	330	355	377
967		255	266	277	288	299	310	345	370	392
2BNL		250	262	274	286	299	311	346	375	399
6BNL		263	276	288	300	313	325	362	390	415
A125 - A225 - A325 - A425		242	253	264	275	286	297	330	355	377
A167 - A267 - A367 - A467		255	266	277	288	299	310	345	370	392
Scor. Cod. 524057	n.	12	14	16	18	20	22	26	30	34
Sup. Cod. 313599	n.	4	4	4	4	4	4	5	5	5



CHIARA

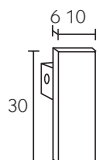

353245

Tappo
Endcap
Bouchon

Endkappe
Tapón
Zatyczka

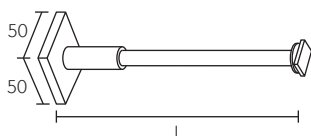

3133--

Supporto
Bracket
Support

Träger
Soporte
Wspornik

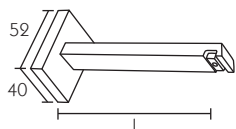

3532--

Supporto
Bracket
Support

Träger
Soporte
Wspornik



72

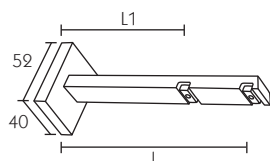

3532--

Supporto doppio
Double bracket
Support double

Doppelträger
Soporte doble
Wspornik podwójny

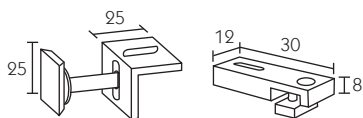

313598

Supporto a soffitto
Ceiling bracket
Support à plafond

313599

Deckenträger
Soporte a techo
Wspornik do sufitu

Cod.	353245
FIN	
25	14,20
67	18,30

Cod.		313368	313318	313328
FIN	I - mm	110	160	210
25		35,90	35,90	38,40
67		44,00	44,00	48,00

Cod.		353209	353219	353269
FIN	I - mm	110	160	210
25		47,00	49,00	51,00
67		61,20	64,30	67,30

Cod.		353217	353227
FIN	I - mm	160	210
	L1 - mm	90	160
25		51,50	53,50
67		66,30	69,50

Cod.	313598	313599
FIN		
25	11,40	14,30
67	11,40	15,70

Components

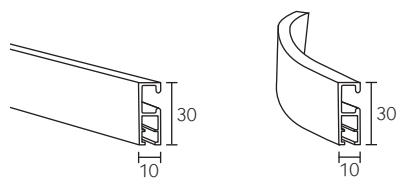

353200

Profilo
Profile
Profil
Profil
Perfil
Profil

3130--

Curva
Curve
Courbe
Kurve
Curva
Kolanko

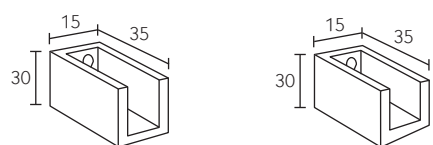

313011

Rosetta a muro
Recess bracket
Naissance murale

313012

Wandlager
Soporte lateral
Podkładka do muru



524057

Scorrevole
Runner
Glisseur

1065

Gleiter
Corredera
Ślizgacze

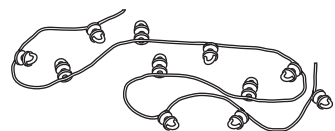

1065--

Scorrevoli
Runners
Glisseurs

Gleiter
Correderas
Ślizgacze

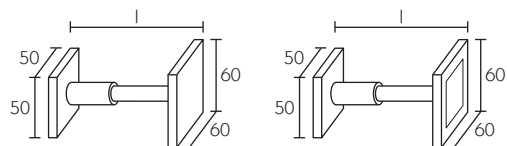

5130--

Fermatenda
Holdback
Porte-embrasse

Raffhalter
Alzapaño
Przytrzymanie firanki

Cod.		353200	313007	313008	313009
FIN	mm		110	160	210
25		30,60	45,00	47,00	49,00
39		30,60	45,00	47,00	49,00
67		37,20	45,00	47,00	49,00
BNL		37,20	45,00	47,00	49,00
A1 - A2 - A3 - A4		30,60	45,00	47,00	49,00

Cod.		313011SX / DX	313012SX / DX
FIN			
25		23,50	28,60
67		23,50	28,60

Cod.		524057	1065
FIN			
25		2,44	
67		2,44	0,08

Cod.		1065P6*	1065P8**
FIN			
Euro/mt		6,74	6,74

* Scorrevoli passo 60 mm - Runners each 60 mm - Glisseurs tous les 60 mm - Gleiter je 60 mm - Correderas cada 60 mm - Ślizgi co 60 mm
** Scorrevoli passo 80 mm - Runners each 80 mm - Glisseurs tous les 80 mm - Gleiter je 80 mm - Correderas cada 80 mm - Ślizgi co 80 mm

Cod.		513091	513092	513093
FIN	l - mm	100	150	200
25 - 39		53,00	57,00	61,00
67		58,30	62,80	67,30
BNL - 2BNL - 6BNL		58,30	62,80	67,30
A125 - A225 - A325 - A425		58,30	62,80	67,30
A167 - A267 - A367 - A467		58,30	62,80	67,30



ALUMINIUM COLLECTION

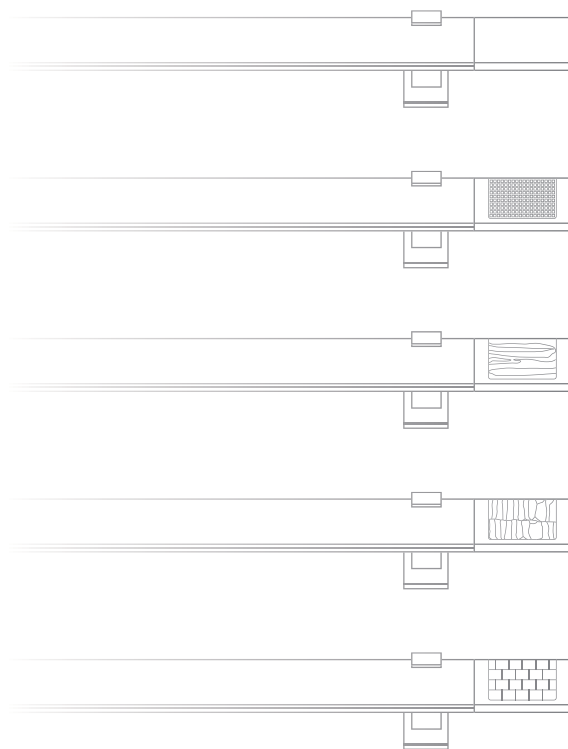

CLARA

FINITURE - FINISHES - FINITIONS - FERTIGUNGEN - ACABADOS - WYKOŃCZENIA

25	BNL	A	BB	CB	SB	MB
67		B	BC	CC	SC	MG
		W	BM	CM	SM	MR
			BN	CN	SN	
			BR	CR	SR	



CLARA



Fin. 25B

Alluminio colore acciaio satinato - Rovere naturale
Anodized aluminium steel color - Natural oak
Aluminium anodisé coloris acier - Chêne
Aluminium eloxiert Stahl Farbe - Eiche
Aluminio anodizado color acero - Roble natural
Aluminium w kolorze stali matowej - Dąb naturalny



Fin. 67BB

Alluminio lucido - Bufalino bianco
Bright aluminium - White buff
Aluminium poli - Buffle blanc
Aluminium poliert - Weisser Büffe
Aluminio pulido - Bufalino blanco
Aluminium polerowane - Cielęca biała



Fin. 67MR

Alluminio lucido - Madreperla rosa
Bright aluminium - Pink mother of pearl
Aluminium poli - Nacre rose
Aluminium poliert - Perlmutter rosa
Aluminio pulido - Nácar rosa
Aluminium polerowane - Masa perłowa różowa

CLARA

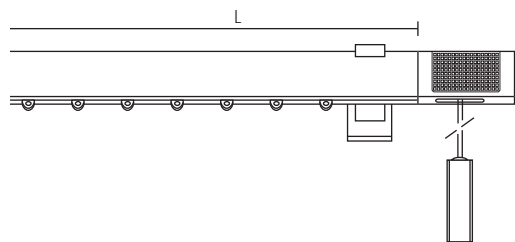

Scorritenda completo a parete
Complete curtain set
Tringle complète pose murale
Komplette Wandgarnitur
Conjunto completo a pared
Karnisz kompletny montaż do ściany

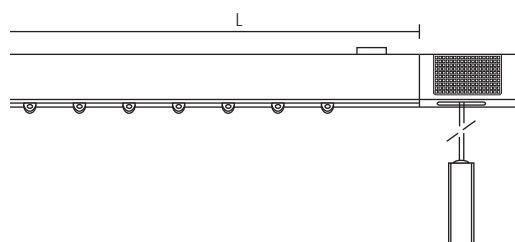

Scorritenda completo a soffitto
Complete curtain set with ceiling bracket
Tringle complète à plafond
Komplette Deckengarnitur
Conjunto completo a techo
Karnisz kompletny do sufitu

FIN. = Finitura - Finish - Finition - Fertigung - Acabado - Wykonczenie
Scor. = Scorrevoli - Runners - Glisseurs - Gleiter - Correderas - Ślizgacze
Sup. = Supporti - Brackets - Supports - Träger - Soportes - Wsporniki

Cod. 403A03

FIN	cm	120	140	160	180	200	220	250	300	340
25		314	322	331	340	353	409	422	443	460
67		358	367	377	387	401	472	486	510	529
BNL		358	367	377	387	401	472	486	510	529
25 + strass		350	358	367	376	389	445	458	479	496
25 + wood		334	342	351	360	373	429	442	463	480
25 + sky		338	346	355	364	377	433	446	467	484
25 + pearl		362	370	379	388	401	457	470	491	508
67 + strass		394	403	413	423	437	508	522	546	565
67 + wood		378	387	397	407	421	492	506	530	549
67 + sky		382	391	401	411	425	496	510	534	553
67 + pearl		406	415	425	435	449	520	534	558	577
BNL + strass		384	393	403	413	427	498	512	536	555
BNL + wood		368	377	387	397	411	482	496	520	539
BNL + sky		372	381	391	401	415	486	500	524	543
BNL + pearl		396	405	415	425	439	510	524	548	567
Scor. Cod. 1000	n.	16	20	22	24	28	30	36	42	46
Sup. cm 9	n.	2	2	2	2	2	3	3	3	3

Cod. 403T03

FIN	cm	120	140	160	180	200	220	250	300	340
25		268	276	285	294	307	340	353	374	391
67		298	308	317	327	342	382	397	421	440
BNL		298	308	317	327	342	382	397	421	440
25 + strass		304	312	321	330	343	376	389	410	427
25 + wood		288	296	305	314	327	360	373	394	411
25 + sky		292	300	309	318	331	364	377	398	415
25 + pearl		316	324	333	342	355	388	401	422	439
67 + strass		334	344	353	363	378	418	433	457	476
67 + wood		318	328	337	347	362	402	417	441	460
67 + sky		322	332	341	351	366	406	421	445	464
67 + pearl		346	356	365	375	390	430	445	469	488
BNL + strass		324	334	343	353	368	408	423	447	466
BNL + wood		308	318	327	337	352	392	407	431	450
BNL + sky		312	322	331	341	356	396	411	435	454
BNL + pearl		336	346	355	365	380	420	435	459	478
Scor. Cod. 1000	n.	16	20	22	24	28	30	36	42	46
Sup.	n.	2	2	2	2	2	3	3	3	3

CLARA

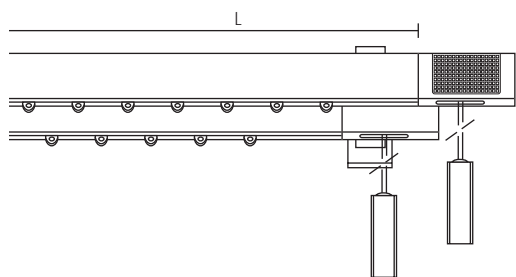

Scorritenda completo doppio a parete
 Complete double curtain set
 Tringle complète double pose murale
 Komplette Doppelgarnitur
 Conjunto completo doble a pared
 Karnisz podwójny kompletny montaż do ściany

FIN. = Finitura - Finish - Finition - Fertigung - Acabado - Wykonczenie
 Scor. = Scorrevoli - Runners - Glisseurs - Gleiter - Correderas - Ślizgacze
 Sup. = Supporti - Brackets - Supports - Träger - Soportes - Wsporniki

Cod. 403B03

FIN	cm	120	140	160	180	200	220	250	300	340
25		542	560	577	594	621	690	716	759	793
67		604	623	643	662	691	777	806	854	892
BNL		604	623	643	662	691	777	806	854	892
25 + strass		578	596	613	630	657	726	752	795	829
25 + wood		562	580	597	614	641	710	736	779	813
25 + sky		566	584	601	618	645	714	740	783	817
25 + pearl		590	608	625	642	669	738	764	807	841
67 + strass		640	659	679	698	727	813	842	890	928
67 + wood		624	643	663	682	711	797	826	874	912
67 + sky		628	647	667	686	715	801	830	878	916
67 + pearl		652	671	691	710	739	825	854	902	940
BNL + strass		630	649	669	688	717	803	832	880	918
BNL + wood		614	633	653	672	701	787	816	864	902
BNL + sky		618	637	657	676	705	791	820	868	906
BNL + pearl		642	661	681	700	729	815	844	892	930
Scor. Cod. 1000	n.	16/16	20/20	22/22	24/24	28/28	30/30	36/36	42/42	46/46
Sup.	n.	2	2	2	2	2	3	3	3	3

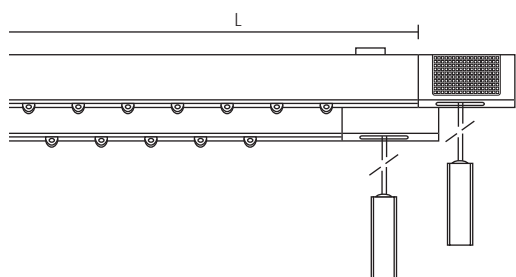

Scorritenda completo doppio a soffitto
 Complete double curtain set with ceiling bracket
 Tringle complète double à plafond
 Komplette Decken-Doppelgarnitur
 Conjunto completo doble a techo
 Karnisz kompletny podwójny do sufitu

Cod. 403W03

FIN	cm	120	140	160	180	200	220	250	300	340
25		496	514	531	548	575	621	647	690	724
67		545	565	584	603	632	689	718	766	804
BNL		545	565	584	603	632	689	718	766	804
25 + strass		532	550	567	584	611	657	683	726	760
25 + wood		516	534	551	568	595	641	667	710	744
25 + sky		520	538	555	572	599	645	671	714	748
25 + pearl		544	562	579	596	623	669	695	738	772
67 + strass		581	601	620	639	668	725	754	802	840
67 + wood		565	585	604	623	652	709	738	786	824
67 + sky		569	589	608	627	656	713	742	790	828
67 + pearl		593	613	632	651	680	737	766	814	852
BNL + strass		571	591	610	629	658	715	744	792	830
BNL + wood		555	575	594	613	642	699	728	776	814
BNL + sky		559	579	598	617	646	703	732	780	818
BNL + pearl		583	603	622	641	670	727	756	804	842
Scor. Cod. 1000	n.	16/16	20/20	22/22	24/24	28/28	30/30	36/36	42/42	46/46
Sup.	n.	2	2	2	2	2	3	3	3	3

Components

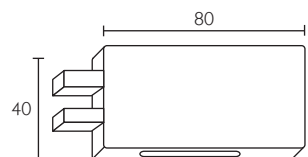

403003

Terminale a corda Endstück für Schnurzug
 Fial for cord Terminal para cuerda
 Embout pour tirage Końcówka ze sznurkiem

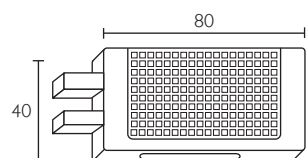

403004

Terminale a corda Endstück für Schnurzug
 Fial for cord Terminal para cuerda
 Embout pour tirage Końcówka ze sznurkiem

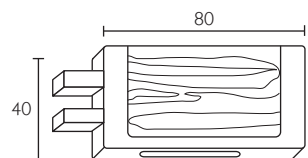

403004

Terminale a corda Endstück für Schnurzug
 Fial for cord Terminal para cuerda
 Embout pour tirage Końcówka ze sznurkiem

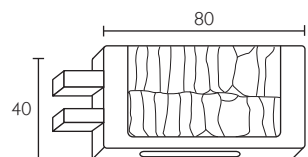

403004

Terminale a corda Endstück für Schnurzug
 Fial for cord Terminal para cuerda
 Embout pour tirage Końcówka ze sznurkiem

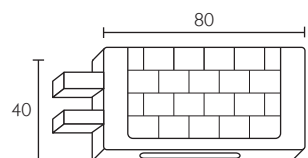

403004

Terminale a corda Endstück für Schnurzug
 Fial for cord Terminal para cuerda
 Embout pour tirage Końcówka ze sznurkiem

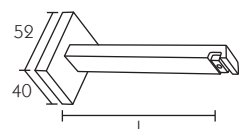

3530--

Supporto Träger
 Bracket Soporte
 Support Wspornik

Cod.	403003SX / DX		
FIN			
25			48,00
67			53,00
BNL			53,00

Cod.	403004SX / DX		
FIN			
25 + strass			66,00
67 + strass			71,00
BNL + strass			66,00

Cod.	403004SX / DX		
FIN			
25 + wood			58,00
67 + wood			63,00
BNL + wood			58,00

Cod.	403004SX / DX		
FIN			
25 + sky			60,00
67 + sky			65,00
BNL + sky			60,00

Cod.	403004SX / DX		
FIN			
25 + pearl			72,00
67 + pearl			77,00
BNL + pearl			72,00

Cod.		353009	353019	353069
FIN	l - mm	90	160	210
25		47,00	49,00	51,00
67		61,00	64,30	67,30
BNL		61,00	64,30	67,30



CLARA

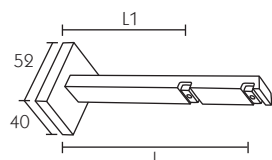

3530--

Supporto doppio
Double bracket
Support double

Doppelträger
Soporte doble
Wspornik podwójny

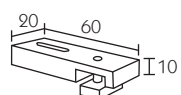

353519

Supporto a soffitto
Ceiling bracket
Support à plafond
Deckenträger
Soporte a techo
Wspornik do sufitu

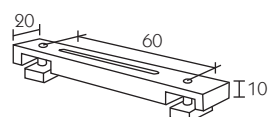

353517

Supporto doppio a soffitto
Double ceiling bracket
Support à plafond double
Decken-Doppelträger
Soporte doble a techo
Wspornik podwójny do sufitu

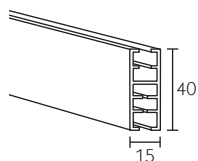

403300

Profilo
Profile
Profil
Profil
Perfil
Profil

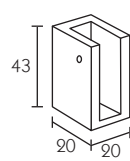

403011

Rosetta a muro
Recess bracket
Naissance murale
Wandlager
Soporte lateral
Podkładka do muru



80



1000

Scorrevole
Runner
Glisseur



1001

Gleiter
Corredera
Slizgacze

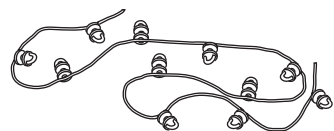

1000--

Scorrevoli
Runners
Glisseurs

Gleiter
Correderas
Slizgacze

Cod.		353017	353027
FIN	I - mm	150	220
	L1 - mm	90	160
25		51,50	53,50
67		66,30	69,50
BNL		66,30	69,50

Cod.		353519	353517
FIN			
25		24,00	28,50
67		31,20	37,00
BNL		31,20	37,00

Cod.		403300	403011SX / DX
FIN			
25		42,00	28,50
67		47,00	34,20
BNL		47,00	34,20

Cod.		1000	1001
FIN			
		0,08	0,61

Cod.		1000P6*	1000P8**
FIN			
Euro/mt		6,74	6,74

* Scorrevoli passo 60 mm - Runners each 60 mm - Glisseurs tous les 60 mm - Gleiter je 60 mm - Correderas cada 60 mm - Ślizgi co 60 mm
** Scorrevoli passo 80 mm - Runners each 80 mm - Glisseurs tous les 80 mm - Gleiter je 80 mm - Correderas cada 80 mm - Ślizgi co 80 mm

Components

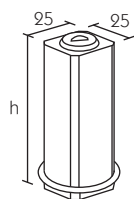

563007

Fiocco piatto
Flat weight
Contrepoids plat

Schnurbeschwerer
Contrapeso plano
Obciążnik płaski

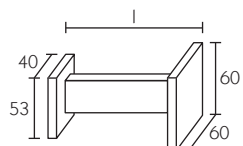

5130--

Fermatenda
Holdback
Porte-embrasse

Raffhalter
Alzapaño
Przytrzymanie firanki

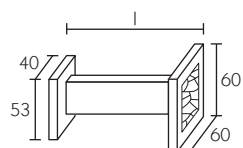

5130--

Fermatenda
Holdback
Porte-embrasse

Raffhalter
Alzapaño
Przytrzymanie firanki

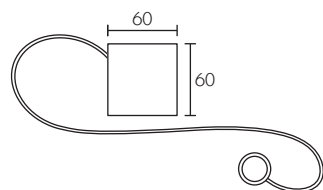

513080

Fermatenda
Holdback
Porte-embrasse

Raffhalter
Alzapaño
Przytrzymanie firanki

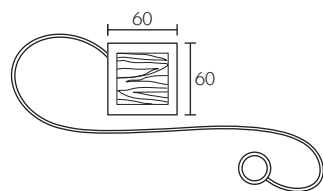

513090

Fermatenda
Holdback
Porte-embrasse

Raffhalter
Alzapaño
Przytrzymanie firanki

Cod.		563007	563008
FIN	h - mm	80	100
25		23,50	26,00
67		26,00	31,00
BNL		26,00	31,00

Cod.		513031	513032	513033
FIN	l - mm	100	150	200
25		76,70	81,70	86,70
67		84,30	89,90	95,50
BNL		84,30	89,90	95,50

Cod.		513094	513095	513096
FIN	l - mm	100	150	200
25 + sky		88,70	93,70	98,70
25 + wood		90,70	95,70	100,70
25 + pearl		111,70	116,70	121,70
25 + strass		101,70	106,70	111,70
67 + sky		96,30	101,90	107,50
67 + wood		98,30	103,90	109,50
67 + pearl		119,30	124,90	130,50
67 + strass		109,30	114,90	120,50
BNL + sky		96,30	101,90	107,50
BNL + wood		98,30	103,90	109,50
BNL + strass		109,30	114,90	120,50
BNL + pearl		119,30	124,90	130,50

Cod.		513080
FIN		
25		38,00
67		41,80
BNL		41,80

Cod.		513090
FIN		
25 + sky		50,00
25 + wood		52,00
25 + strass		63,00
67 + sky		53,80
67 + wood		55,80
67 + strass		66,80
BNL + sky		53,80
BNL + wood		55,80
BNL + strass		66,80



ALUMINIUM COLLECTION

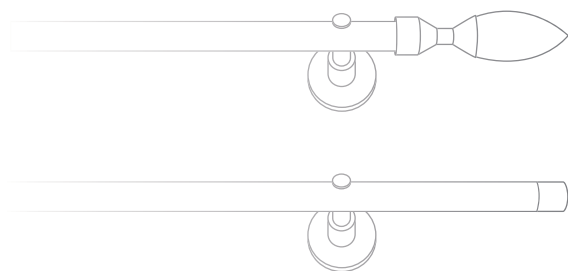

DIVA 20

FINITURE - FINISHES - FINITIONS - FERTIGUNGEN - ACABADOS - WYKOŃCZENIA

67	167	A
81	181	B
		C
		D
		W





Fin. 167

Alluminio lucido - Alluminio satinato opaco
 Bright aluminium - Satin mat aluminium
 Aluminium poli - Aluminium satiné mat

Aluminium poliert - Aluminium satiniert matt
 Aluminio pulido - Aluminio satinado mate
 Aluminium polerowane - Aluminium satynowy matowy



Fin. 67

Alluminio lucido
 Bright aluminium
 Aluminium poli

Aluminium poliert
 Aluminio pulido
 Aluminium polerowane



Fin. A



Fin. B



Fin. C



Fin. D



Fin. W

DIVA 20

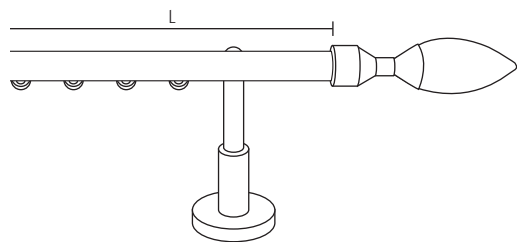

Scorritenda completo a parete
Complete curtain set
Tringle complète pose murale
Komplette Wandgarnitur
Conjunto completo a pared
Karnisz kompletny montaż do ściany

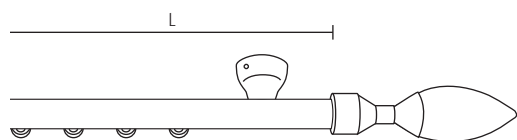

Scorritenda completo a soffitto
Complete curtain set with ceiling bracket
Tringle complète à plafond
Komplette Deckengarnitur
Conjunto completo a techo
Karnisz kompletny do sufitu

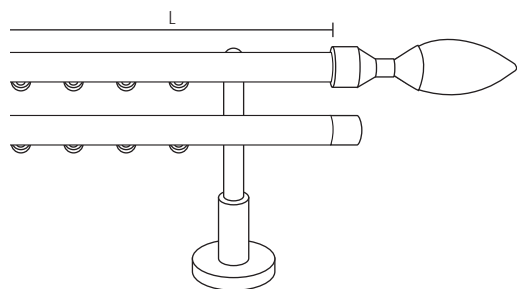

Scorritenda completo doppio a parete
Complete double curtain set
Tringle complète double pose murale
Komplette Doppelgarnitur
Conjunto completo doble a pared
Karnisz podwójny kompletny montaż do ściany

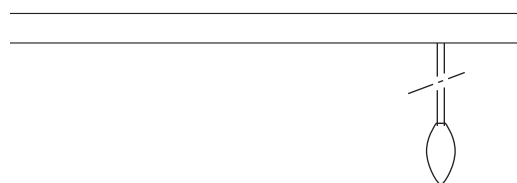

FIN. = Finitura - Finish - Finition - Fertigung - Acabado - Wykonczenie
Scor. = Scorrevoli - Runners - Glisseurs - Gleiter - Correderas - Ślizgacze
Sup. = Supporti - Brackets - Supports - Träger - Soportes - Wsporniki

Cod. 203A03

Ø 20 mm

FIN	cm	120	140	160	180	200	220	250	300	340
181		175	184	191	198	207	250	263	282	297
167		169	178	186	194	204	242	256	277	293
67 A - B - C - D - W		168	177	184	192	201	243	256	276	290
81 A - B - C - D - W		155	164	172	179	188	225	239	258	273
Scor. Cod. 1012	n.	16	20	22	24	28	30	36	42	46
Sup. cm 8 - 16	n.	2	2	2	2	2	3	3	3	3

Cod. 203T03

Ø 20 mm

FIN	cm	120	140	160	180	200	220	250	300	340
181		138	147	154	162	171	195	208	227	242
167		142	152	160	168	177	202	216	237	253
67 A - B - C - D - W		131	140	148	155	164	188	201	221	235
81 A - B - C - D - W		129	138	145	152	161	185	199	218	233
Scor. Cod. 1012	n.	16	20	22	24	28	30	36	42	46
Sup. cm 2	n.	2	2	2	2	2	3	3	3	3

Cod. 203B03

Ø 20/20 mm

FIN	cm	120	140	160	180	200	220	250	300	340
181		265	283	298	312	330	386	413	451	481
167		262	281	297	313	332	386	414	456	488
67 A - B - C - D - W		258	276	291	306	324	379	406	445	474
81 A - B - C - D - W		245	262	277	292	310	362	389	427	457
Scor. Cod. 1012	n.	16/16	20/20	22/22	24/24	28/28	30/30	36/36	42/42	46/46
Sup. cm 16	n.	2	2	2	2	2	3	3	3	3

Maggiorazione movimento a corda - Surcharge for corded systems - Supplément pour tirage
Zuschlag für Schnurbedienung - Suplemento por cuerda - Dodatkowo koszt mechanizmu

cm	120	140	160	180	200	220	250	300	340
	65	65	65	65	70	70	70	70	70



DIVA 20

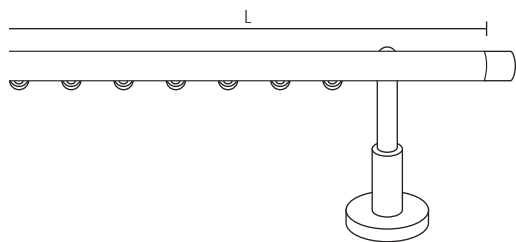

Scorritenda completo a parete
Complete curtain set
Tringle complète pose murale
Komplette Wandgarnitur
Conjunto completo a pared
Karnisz kompletny montaż do ściany

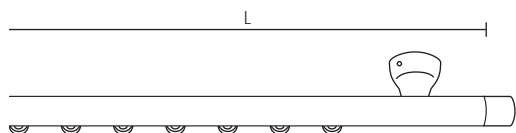

Scorritenda completo a soffitto
Complete curtain set with ceiling bracket
Tringle complète à plafond
Komplette Deckengarnitur
Conjunto completo a techo
Karnisz kompletny do sufitu

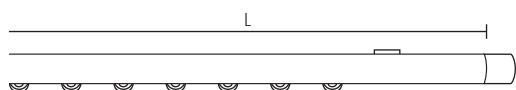

Scorritenda completo a soffitto
Complete curtain set with ceiling bracket
Tringle complète à plafond
Komplette Deckengarnitur
Conjunto completo a techo
Karnisz kompletny do sufitu

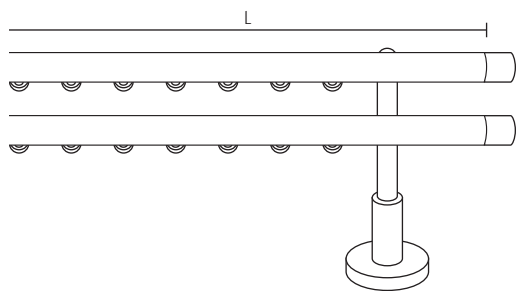

Scorritenda completo doppio a parete
Complete double curtain set
Tringle complète double pose murale
Komplette Doppelgarnitur
Conjunto completo doble a pared
Karnisz podwójny kompletny montaż do ściany

FIN. = Finitura - Finish - Finition - Fertigung - Acabado - Wykonczenie
Scor. = Scorrevoli - Runners - Glisseurs - Gleiter - Correderas - Ślizgacze
Sup. = Supporti - Brackets - Supports - Träger - Soportes - Wsporniki

Cod. 203A15		Ø 20 mm								
FIN	cm	120	140	160	180	200	220	250	300	340
181		148	157	164	172	181	223	237	256	270
167		138	148	156	164	174	212	226	247	263
67 A - B - C - D - W		148	157	164	172	181	223	237	256	270
81 A - B - C - D - W		135	144	151	158	167	205	218	237	252
Scor.	n.	16	20	22	24	28	30	36	42	46
Sup. cm 8 - 16	n.	2	2	2	2	2	3	3	3	3

Cod. 203T15		Ø 20 mm								
FIN	cm	120	140	160	180	200	220	250	300	340
181		112	121	128	135	144	168	182	201	216
167		112	121	129	137	147	171	186	207	223
67 A - B - C - D - W		112	121	128	135	144	168	182	201	216
81 A - B - C - D - W		108	117	124	131	140	164	178	197	212
Scor.	n.	16	20	22	24	28	30	36	42	46
Sup. cm 2	n.	2	2	2	2	2	3	3	3	3

Cod. 203Z15		Ø 20 mm								
FIN	cm	120	140	160	180	200	220	250	300	340
181		110	119	126	133	142	165	179	198	213
167		110	119	127	135	145	168	183	204	220
67 A - B - C - D - W		110	119	126	133	142	165	179	198	213
81 A - B - C - D - W		106	115	122	129	138	161	175	194	209
Scor.	n.	16	20	22	24	28	30	36	42	46
Sup. Cod. 203299	n.	2	2	2	2	2	3	3	3	3

Cod. 203B45		Ø 20/20 mm								
FIN	cm	120	140	160	180	200	220	250	300	340
181		239	256	271	286	304	359	386	425	454
167		231	251	267	283	302	355	384	426	458
67 A - B - C - D - W		239	256	271	286	304	359	386	425	454
81 A - B - C - D - W		224	242	256	271	289	341	368	406	436
Scor.	n.	16/16	20/20	22/22	24/24	28/28	30/30	36/36	42/42	46/46
Sup. cm 16	n.	2	2	2	2	2	3	3	3	3



Components

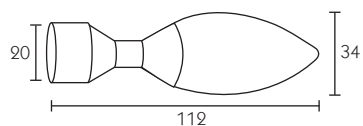

203003

Terminale
Fial
Embout

Endstück
Terminal
Końcówka

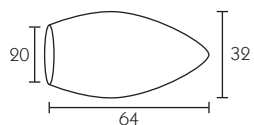

203075

Terminale
Fial
Embout

Endstück
Terminal
Końcówka

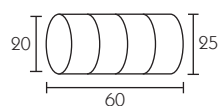

203072

Terminale
Fial
Embout

Endstück
Terminal
Końcówka

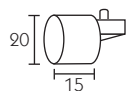

203145

Tappo
Endcap
Bouchon

Endkappe
Tapón
Zatyczka

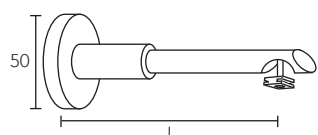

2032--

Supporto
Bracket
Support

Träger
Soporte
Wspornik

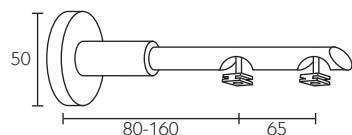

203245

Supporto doppio
Double bracket
Support double

Doppelträger
Soporte doble
Wspornik podwójny

Cod.		203003
FIN	Ø mm	20
167 - 181		28,80
67 A - B - C - D - W		25,40
81 A - B - C - D - W		24,00

Cod.		203075
FIN	Ø mm	20
67		17,40
81		14,50

Cod.		203072
FIN	Ø mm	20
167 - 181		32,00
67 A - B - C - D - W		28,00
81 A - B - C - D - W		27,00

Cod.		203145
FIN	Ø mm	20
67		15,50
81		13,60

Cod.		203225	203235
FIN	Ø mm	20	20
	l - mm	160	230
67		34,90	37,30
81		30,00	33,70

Cod.		203245
FIN	Ø mm	20
67		40,90
81		37,30



DIVA 20

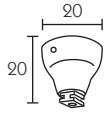

203295

Supporto a soffitto
Ceiling bracket
Support à plafond

Deckenträger
Soporte a techo
Wspornik do sufitu

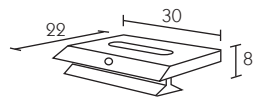

203299

Supporto Zero
Bracket Zero
Support Zero

Träger Zero
Soporte Zero
Wspornik Zero

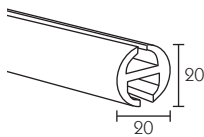

203200

Profilo
Profile
Profil

Profil
Perfil
Profil



88

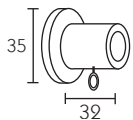

203001

Rosetta a muro
Recess bracket
Naissance murale

Wandlager
Soporte lateral
Podkładka do muru

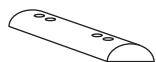

564018

Giunzione
Junction
Jonction

Verbinder
Enchufe
Łącznik

Cod.		203295
FIN	Ø mm	20
67		16,60
81		16,60

Cod.		203299
FIN		
67		15,60
81		15,60

Cod.		203200
FIN	Ø mm	20
67		32,00
81		28,80
A - B - C - D - W		28,80

Cod.		203001
FIN	Ø mm	20
67		19,50
81		17,60

Cod.		564018
FIN	Ø mm	20
		19,20

Components



1012
Scorrevole
Runner
Glisseur



1065
Gleiter
Corredera
Ślizgacze

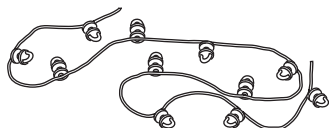

1065--
Scorrevoli
Runners
Glisseurs

Gleiter
Correderas
Ślizgacze

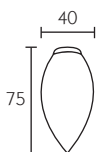

563001
Fiocco
Weight
Contrepoids

Schnurbeschwerer
Contrapeso
Obciążnik

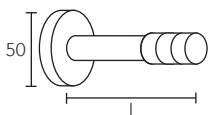

5130--
Fermatenda alluminio
Aluminum holdback
Porte - embrasse en alu

Raffhalter Alu
Alzapaño en aluminio
Przytrzymanie aluminium

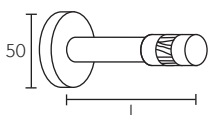

5130--
Fermatenda
Holdback
Porte-embrasse

Raffhalter
Alzapaño
Przytrzymanie firanki

Cod.	1012	1065
FIN	0,80	0,08

Cod.	1065P6*	1065P8**
FIN		
Euro/mt	6,74	6,74

* Scorrevoli passo 60 mm - Runners each 60 mm - Glisseurs tous les 60 mm - Gleiter je 60 mm - Correderas cada 60 mm - Ślizgi co 60 mm
** Scorrevoli passo 80 mm - Runners each 80 mm - Glisseurs tous les 80 mm - Gleiter je 80 mm - Correderas cada 80 mm - Ślizgi co 80 mm

Cod.		563001
FIN	Ø mm	25
67		22,90
81		22,90

Cod.		513059	513069	513079
FIN	l - mm	100	150	200
167		38,00	38,00	38,00
181		38,00	38,00	38,00

Cod.		513059	513069	513079
FIN	l - mm	100	150	200
67 A - B - C - D - W		39,00	39,00	39,00
81 A - B - C - D - W		32,70	32,70	32,70



ALUMINIUM COLLECTION

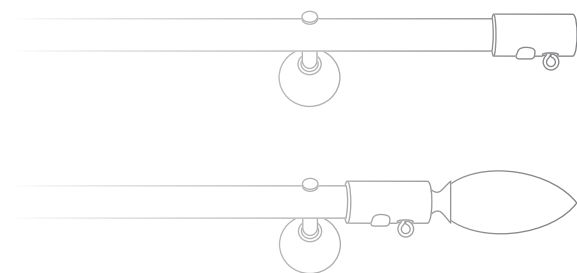

DIVA 25

FINITURE - FINISHES - FINITIONS - FERTIGUNGEN - ACABADOS - WYKOŃCZENIA

39	6BNL	A1	A
67	7BNL	A2	B
75		A3	W
		A4	





Fin. 67
 Alluminio lucido
 Bright aluminium
 Aluminium poli

Aluminium poliert
 Aluminio pulido
 Aluminium polerowane



Fin. 75
 Alluminio satinato verniciato semilucido
 Semi-bright painted satin aluminium
 Aluminium satiné verni semi-poli

Aluminium satiniert lackiert halb-glaenzend
 Aluminio satinado barnizado semipulido
 Aluminium satyna lakierowane półpołysk



Fin. 75VB



Fin. 75VG



Fin. 75VR



Fin. 75VV

DIVA 25

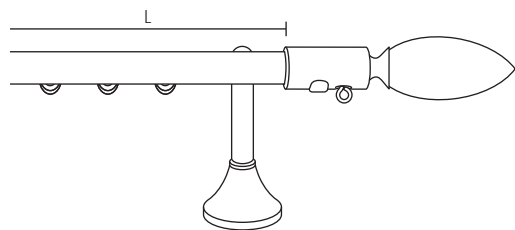

Scorritenda completo a parete
Complete curtain set
Tringle complète pose murale
Komplette Wandgarnitur
Conjunto completo a pared
Karnisz kompletny montaż do ściany

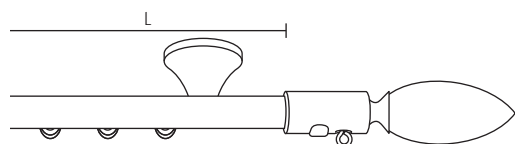

Scorritenda completo a soffitto
Complete curtain set with ceiling bracket
Tringle complète à plafond
Komplette Deckengarnitur
Conjunto completo a techo
Karnisz kompletny do sufitu

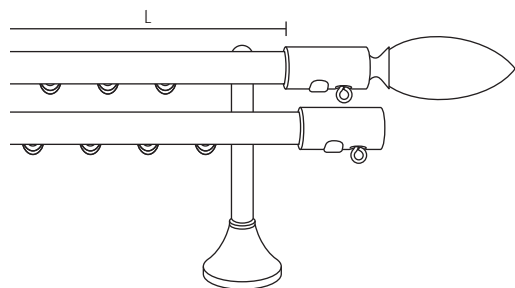

Scorritenda completo doppio a parete
Complete double curtain set
Tringle complète double pose murale
Komplette Doppelgarnitur
Conjunto completo doble a pared
Karnisz podwójny kompletny montaż do ściany

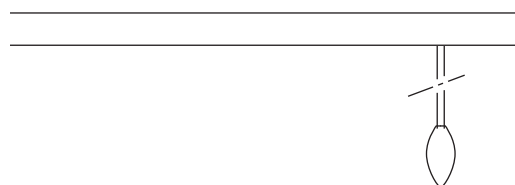

FIN. = Finitura - Finish - Finition - Fertigung - Acabado - Wykonczenie
Scor. = Scorrevoli - Runners - Glisseurs - Gleiter - Correderas - Ślizgacze
Sup. = Supporti - Brackets - Supports - Träger - Soportes - Wsporniki

Cod. 253A03		Ø 25 mm								
FIN	cm	120	140	160	180	200	220	250	300	340
39 - A1 - A2 - A3 - A4		180	186	192	198	204	243	252	266	278
67		213	220	227	234	241	286	297	315	328
75		180	186	192	198	204	243	252	266	278
67 A - B - W		188	194	200	206	212	256	265	279	291
75 A - B - W		172	178	184	190	196	235	244	258	270
6BNL		213	220	227	234	241	286	297	315	328
7BNL		187	194	201	208	215	255	266	284	297
Scor. Cod. 1000	n.	16	20	22	24	28	30	36	42	46
Sup. cm 16	n.	2	2	2	2	2	3	3	3	3

Cod. 253T03		Ø 25 mm								
FIN	cm	120	140	160	180	200	220	250	300	340
39 - A1 - A2 - A3 - A4		148	154	159	165	171	194	203	218	229
67		178	185	192	199	206	233	244	261	275
75		148	154	159	165	171	194	203	218	229
67 A - B - W		153	159	164	170	176	203	212	226	238
75 A - B - W		140	146	151	157	163	186	195	210	221
6BNL		178	185	192	199	206	233	244	261	275
7BNL		155	162	169	176	183	207	218	235	249
Scor. Cod. 1000	n.	16	20	22	24	28	30	36	42	46
Sup. cm 3	n.	2	2	2	2	2	3	3	3	3

Cod. 253B03		Ø 25 mm								
FIN	cm	120	140	160	180	200	220	250	300	340
39 - A1 - A2 - A3 - A4		257	269	280	292	304	350	368	397	421
67		312	326	340	354	368	427	448	483	511
75		257	269	280	292	304	350	368	397	421
67 A - B - W		280	292	304	315	327	384	402	431	454
75 A - B - W		249	261	272	284	296	342	360	389	413
6BNL		312	326	340	354	368	427	448	483	511
7BNL		270	285	298	312	326	375	397	432	459
Scor. Cod. 1000	n.	16/16	20/20	22/22	24/24	28/28	30/30	36/36	42/42	46/46
Sup. cm 25	n.	2	2	2	2	2	3	3	3	3

Maggiorazione movimento a corda - Surcharge for corded systems - Supplément pour tirage
Zuschlag für Schnurbedienung - Suplemento por cuerda - Dodatkowo koszt mechanizmu

cm	120	140	160	180	200	220	250	300	340
	72	72	72	72	77	77	77	77	77



DIVA 25

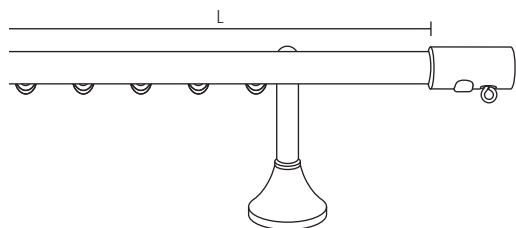

Scorritenda completo a parete
Complete curtain set
Tringle complète pose murale
Komplette Wandgarnitur
Conjunto completo a pared
Karnisz kompletny montaż do ściany

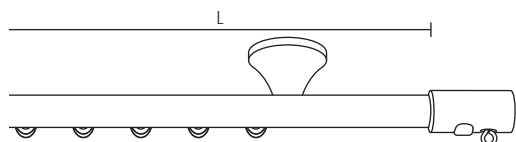

Scorritenda completo a soffitto
Complete curtain set with ceiling bracket
Tringle complète à plafond
Komplette Deckengarnitur
Conjunto completo a techo
Karnisz kompletny do sufitu

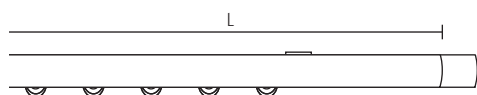

Scorritenda completo a soffitto
Complete curtain set with ceiling bracket
Tringle complète à plafond
Komplette Deckengarnitur
Conjunto completo a techo
Karnisz kompletny do sufitu

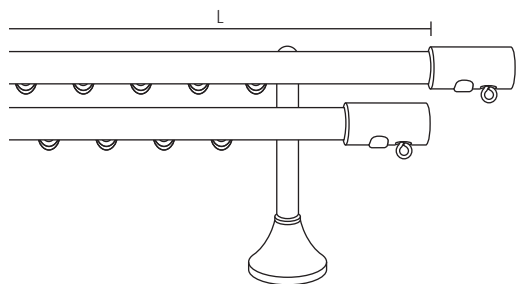

Scorritenda completo doppio a parete
Complete double curtain set
Tringle complète double pose murale
Komplette Doppelgarnitur
Conjunto completo doble a pared
Karnisz podwójny kompletny montaż do ściany

FIN. = Finitura - Finish - Finition - Fertigung - Acabado - Wykonczenie
Scor. = Scorrevoli - Runners - Glisseurs - Gleiter - Correderas - Ślizgacze
Sup. = Supporti - Brackets - Supports - Träger - Soportes - Wsporniki

Cod. 253A02		Ø 25 mm								
FIN	cm	120	140	160	180	200	220	250	300	340
39 - A1 - A2 - A3 - A4		141	146	152	158	164	203	212	227	238
67		163	170	177	184	191	236	247	265	278
75		141	146	152	158	164	203	212	227	238
67 A - B - W		156	162	168	174	180	224	233	247	259
75 A - B - W		141	146	152	158	164	203	212	227	238
6BNL		163	170	177	184	191	236	247	265	278
7BNL		147	154	161	168	175	216	227	244	258
Scor. Cod. 1000	n.	16	20	22	24	28	30	36	42	46
Sup. cm 16	n.	2	2	2	2	2	3	3	3	3

Cod. 253T02		Ø 25 mm								
FIN	cm	120	140	160	180	200	220	250	300	340
39 - A1 - A2 - A3 - A4		108	114	120	126	132	155	164	178	190
67		128	135	142	149	156	183	194	211	225
75		108	114	120	126	132	155	164	178	190
67 A - B - W		121	127	132	138	144	171	180	194	206
75 A - B - W		108	114	120	126	132	155	164	178	190
6BNL		128	135	142	149	156	183	194	211	225
7BNL		115	122	129	136	143	167	178	195	209
Scor. Cod. 1000	n.	16	20	22	24	28	30	36	42	46
Sup. Cod 253295	n.	2	2	2	2	2	3	3	3	3

Cod. 253Z45		Ø 25 mm								
FIN	cm	120	140	160	180	200	220	250	300	340
39 - A1 - A2 - A3 - A4		99	105	111	116	122	144	153	167	179
67		111	118	125	132	139	161	172	189	203
75		99	105	111	116	122	144	153	167	179
67 A - B - W		104	110	116	121	127	149	158	172	184
75 A - B - W		99	105	111	116	122	144	153	167	179
6BNL		111	118	125	132	139	161	172	189	203
7BNL		106	113	120	127	134	156	167	184	198
Scor. Cod. 1000	n.	16	20	22	24	28	30	36	42	46
Sup. Cod. 253299	n.	2	2	2	2	2	3	3	3	3

Cod. 253B02		Ø 25/25 mm								
FIN	cm	120	140	160	180	200	220	250	300	340
39 - A1 - A2 - A3 - A4		217	229	241	252	264	311	329	358	381
67		262	276	290	304	318	377	398	433	461
75		217	229	241	252	264	311	329	358	381
67 A - B - W		248	260	272	283	295	352	370	399	422
75 A - B - W		217	229	241	252	264	311	329	358	381
6BNL		262	276	290	304	318	377	398	433	461
7BNL		231	245	259	273	287	336	357	392	420
Scor. Cod. 1000	n.	16/16	20/20	22/22	24/24	28/28	30/30	36/36	42/42	46/46
Sup. cm 25	n.	2	2	2	2	2	3	3	3	3



Components

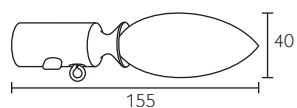

2530--
 Terminale Endstück
 Finial Terminal
 Embout Końcówka

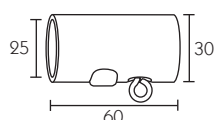

253002
 Terminale Endstück
 Finial Terminal
 Embout Końcówka

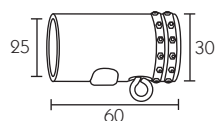

253002SW
 Terminale Endstück
 Finial Terminal
 Embout Końcówka

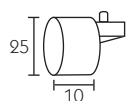

253145
 Tappo Endkappe
 Endcap Tapón
 Bouchon Zatyczka

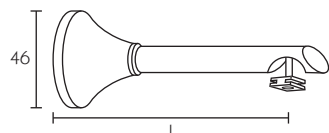

2532--
 Supporto Träger
 Bracket Soporte
 Support Wspornik

Cod.	253003	253004	253005
FIN Ø mm	25	25	25
39 - A1 - A2 - A3 - A4	39,00		
67	47,00		
75	39,00		
67 A - B - W		38,00	
75 A - B - W		35,00	
67 VG - VR - VV			73,00
75 VG - VR - VV			70,00

Cod.	253002
FIN Ø mm	25
39 - A1 - A2 - A3 - A4	19,20
67	22,00
75	19,20

Cod.	253002SW
FIN Ø mm	25
67	34,60
75	30,00

Cod.	253145
FIN Ø mm	25
39 - A1 - A2 - A3 - A4	16,30
67	18,80
75	16,30

Cod.	253225	253235
FIN Ø mm	25	25
	l - mm	250
39 - A1 - A2 - A3 - A4	33,50	33,50
67	38,50	38,50
75	33,50	33,50



DIVA 25

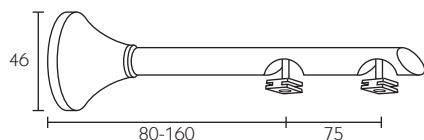

253245

Supporto doppio
Double bracket
Support double

Doppelträger
Soporte doble
Wspornik podwójny

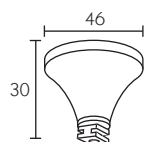

253295

Supporto a soffitto
Ceiling bracket
Support à plafond
Deckenträger
Soporte a techo
Wspornik do sufitu

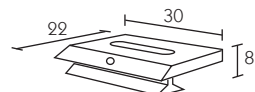

253299

Supporto Zero
Bracket Zero
Support Zero
Träger Zero
Soporte Zero
Wspornik Zero



253294

Supporto soffitto regolabile
Reducible ceiling bracket
Support à plafond réglable
Deckenträger regulierbar
Soporte a techo regulable
Wspornik do sufitu regulowany



96

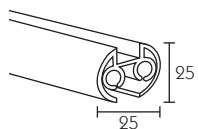

253200

Profilo
Profile
Profil
Profil
Perfil
Profil

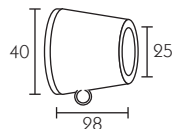

253001

Rosetta a muro
Recess bracket
Naissance murale
Wandlager
Soporte lateral
Podkładka do muru

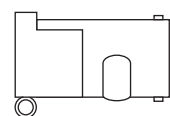

253009

Rosetta per corda
Recess bracket for corded
Naissance pour tirage
Wandlager für Schnur
Soporte para cordon
Przytrzymanie do sznura

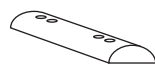

564017

Giunzione
Junction
Jonction
Verbinder
Enchufe
Łącznik

Cod.		253245
FIN	Ø mm	25
39 - A1 - A2 - A3 - A4		35,00
67		45,00
75		35,00

Cod.		253295	253299
FIN	Ø mm	25	
39 - A1 - A2 - A3 - A4		17,30	15,60
67		20,80	15,60
75		17,30	15,60

Cod.		253294
FIN	Ø mm	25
39 - A1 - A2 - A3 - A4		31,60
67		37,60
75		31,60

Cod.		253200	253001
FIN	Ø mm	25	
39 - A1 - A2 - A3 - A4		28,20	21,20
67		33,90	23,50
75		28,20	21,20
A - B - W		28,20	
BNL		33,90	23,50

Cod.		253009	564017
FIN			
67		37,50	
75		31,60	
			19,20

Components



1000
Scorrevole
Runner
Glisseur



1001
Gleiter
Corredera
Ślizgacze

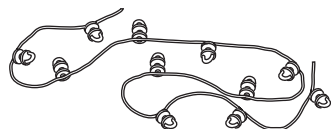

1000--
Scorrevoli
Runners
Glisseurs
Gleiter
Correderas
Ślizgacze

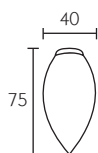

563001
Fiocco
Weight
Contrepoids
Schnurbeschwerer
Contrapeso
Obciążnik

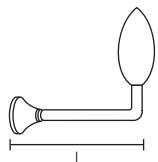

5130--
Fermatenda alluminio
Aluminum holdback
Porte - embrasse en alu
Raffhalter Alu
Alzapaño en aluminio
Przytrzymanie aluminium

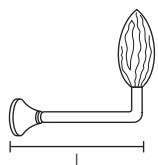

5130--
Fermatenda legno
Wooden holdback
Porte-embrasse en bois
Raffhalter Holz
Alzapaño en madera
Przytrzymanie drewno

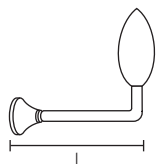

5130--
Fermatenda vetro
Glass holdback
Porte - embrasse en verre
Raffhalter Glas
Alzapaño en vidrio
Przytrzymanie szkło

Cod.	1000	1001
FIN	0,08	0,61

Cod.	1000P6*	1000P8**
FIN		
Euro/mt	6,74	6,74

* Scorrevoli passo 60 mm - Runners each 60 mm - Glisseurs tous les 60 mm - Gleiter je 60 mm - Correderas cada 60 mm - Ślizgi co 60 mm
** Scorrevoli passo 80 mm - Runners each 80 mm - Glisseurs tous les 80 mm - Gleiter je 80 mm - Correderas cada 80 mm - Ślizgi co 80 mm

Cod.	563001	
FIN	Ø mm	25
67		22,90
75		22,90

Cod.	513001	513002	513003	
FIN	I - mm	100	150	200
39 - A1 - A2 - A3 - A4		43,60	43,60	43,60
67		57,00	57,00	57,00
75		43,60	43,60	43,60

Cod.	513004	513005	513006	
FIN	I - mm	100	150	200
67 A - B - W		39,00	39,00	39,00
75 A - B - W		32,70	32,70	32,70

Cod.	513007	513008	513009	
FIN	I - mm	100	150	200
67 VG - VR - VV		87,00	87,00	87,00
75 VG - VR - VV		77,70	77,70	77,70



ALUMINIUM COLLECTION

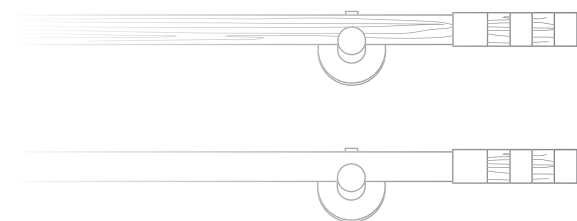

DONNA

FINITURE - FINISHES - FINITIONS - FERTIGUNGEN - ACABADOS - WYKOŃCZENIA

67	A	H
81	B	K
	C	Y
	D	Z
	W	J



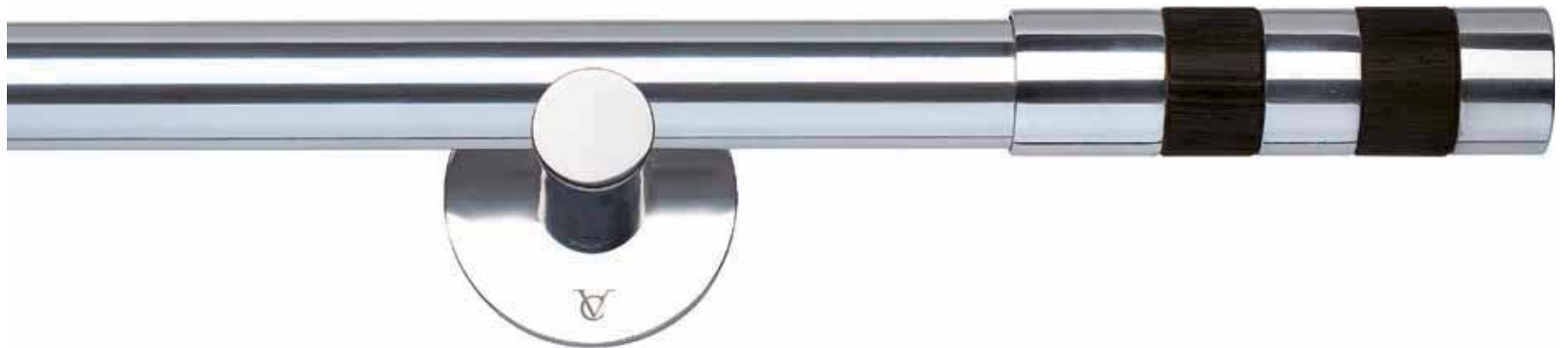

Fin. 67J

Alluminio lucido - Wengé
Bright aluminium - Wengé
Aluminium poli - Wengé

Aluminium poliert - Wengé
Aluminio pulido - Wengé
Aluminium polerowane - Wengé



Fin. 81Z

Alluminio satinato opaco - Noce
Satin mat aluminium - Walnut
Aluminium satiné mat - Noyer

Aluminium satiniert matt - Nußbaum
Aluminio satinado mate - Nogal
Aluminium satynowy matowy - Orzech



Fin. 67C

Rovere sbiancato - Alluminio lucido
Whitened oak - Bright aluminium
Chêne lasuré blanc - Aluminium poli

Geblichte Eiche - Aluminium poliert
Roble blanqueado - Aluminio pulido
Dąb rozjaśniony - Aluminium polerowane

DONNA

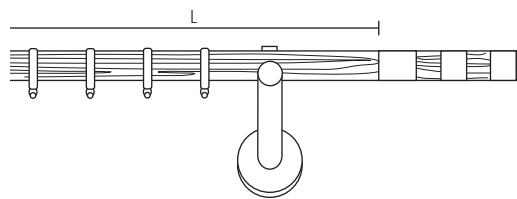

Scorritenda completo a parete
Complete curtain set
Tringle complète pose murale
Komplette Wandgarnitur
Conjunto completo a pared
Karnisz kompletny montaż do ściany

FIN. = Finitura - Finish - Finition - Fertigung - Acabado - Wykonczenie
An. = Anelli - Rings - Anneaux - Ringe - Anillas - Kółka
Sup. = Supporti - Brackets - Supports - Träger - Soportes - Wsporniki

Cod. 203A61		Ø 20 mm								
FIN	cm	120	140	160	180	200	220	250	300	340
67 A - B - C - D - W		173	186	199	212	225	262	283	313	339
67 J - K - H - Y - Z		159	170	180	191	201	236	254	278	299
81 A - B - C - D - W		164	177	190	203	216	251	272	302	328
81 J - K - H - Y - Z		144	153	163	172	181	213	229	250	269
An.	n.	12	14	16	18	20	22	26	30	34
Sup. Easy cm 9	n.	2	2	2	2	2	3	3	3	3

Cod. 203B61		Ø 20 mm								
FIN	cm	120	140	160	180	200	220	250	300	340
67 A - B - C - D - W		185	198	211	224	236	279	301	331	356
67 J - K - H - Y - Z		171	181	192	202	213	253	271	295	316
81 A - B - C - D - W		183	195	208	221	234	278	299	329	355
81 J - K - H - Y - Z		162	171	181	190	200	240	256	278	296
An.	n.	12	14	16	18	20	22	26	30	34
Sup. Easy cm 16	n.	2	2	2	2	2	3	3	3	3

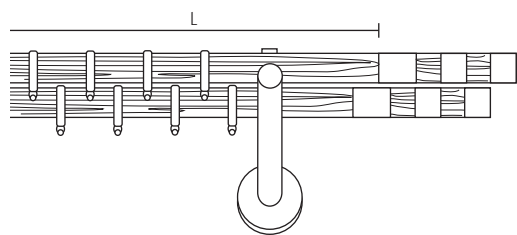

Scorritenda completo doppio a parete
Complete double curtain set
Tringle complète double pose murale
Komplette Doppelgarnitur
Conjunto completo doble a pared
Karnisz podwójny kompletny montaż do ściany

Cod. 203C61		Ø 20/20 mm								
FIN	cm	120	140	160	180	200	220	250	300	340
67 A - B - C - D - W		331	357	382	408	434	500	543	603	654
67 J - K - H - Y - Z		303	324	345	366	387	448	484	532	574
81 A - B - C - D - W		316	342	367	393	419	482	524	584	636
81 J - K - H - Y - Z		275	293	312	331	350	406	438	481	519
An.	n.	12/12	14/14	16/16	18/18	20/20	22/22	26/26	30/30	34/34
Sup. Easy cm 8	n.	2	2	2	2	2	3	3	3	3



DONNA

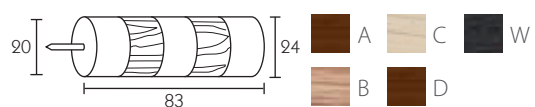

203061

Terminale
Finial
Embout

Endstück
Terminal
Końcówka

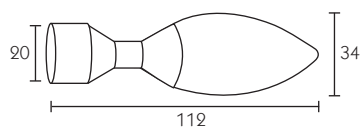

203003

Terminale
Finial
Embout

Endstück
Terminal
Końcówka

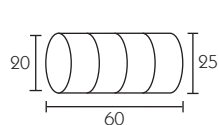

203072

Terminale
Finial
Embout

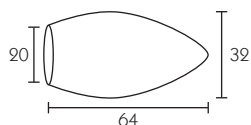

203075

Endstück
Terminal
Końcówka

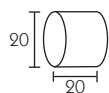

203045

Tappo
Endcap
Bouchon

Endkappe
Tapón
Zatyczka

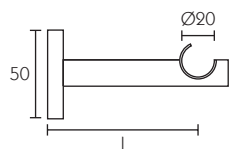

2033--

Supporto
Bracket
Support

Träger
Soporte
Wspornik

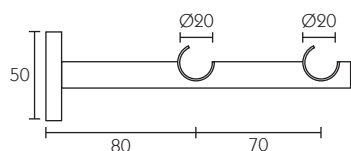

203317

Supporto doppio
Double bracket
Support double

Doppelträger
Soporte doble
Wspornik podwójny

Cod. 203061

FIN	Ø mm	
67	A - B - C - D - W	24,00
81	A - B - C - D - W	21,80

Cod. 203003

FIN	Ø mm	
81	A - B - C - D - W	24,00
67	A - B - C - D - W	25,40

Cod. 203072

FIN	Ø mm	
67		
81		
81	A - B - C - D - W	28,00
67	A - B - C - D - W	27,00

203075

FIN	
67	17,40
81	14,50

Cod. 203045

FIN	Ø mm	
67		12,00
81		10,00

Cod. 203309

FIN	Ø mm	
67		24,20
81		21,90

203319

FIN	
67	30,00
81	31,00

203329

FIN	
67	41,10
81	39,20

Cod. 203317

FIN	Ø mm	
67		40,50
81		37,30



Components

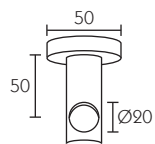

203298

Supporto a soffitto
Ceiling bracket
Support à plafond

Deckenträger
Soporte a techo
Wspornik do sufitu

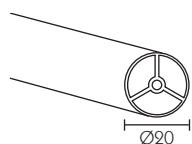

203100

Tubo
Tube
Tube

Rohr
Tubo
Rura

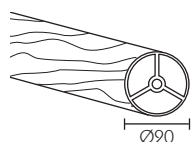

203100

Tubo in alluminio impiallacciato rovere
Aluminium pole oak wood coated
Tube en aluminium plaqué chêne
Alu Rohr ummantelt mit Holz
Tubo en aluminio recubierto en roble
Rura aluminiowa fornirowana dąb

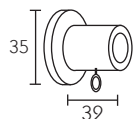

203001

Rosetta a muro
Recess bracket
Naissance murale

Wandlager
Soporte lateral
Podkładka do muru

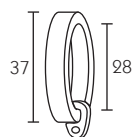

523083

Anello con guarnizione ed occhiolo in plastica
Ring with inlay and plastic eyelet
Anneau avec joint et oeillet plastique
Ring mit Gleitanlage und Faltenleghaken
Anilla con guarnición y ganchino en plástico
Kółko z wkładką teflonową i uchwytem plastikowym

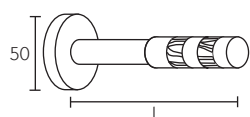

5130--

Fermatenda
Holdback
Porte-embrasse

Raffhalter
Alzapaño
Przytrzymanie firanki

Cod.	203298	
FIN		
67		20,90
81		18,70

Cod.	203100	
FIN	Ø mm	20
67		32,40
81		27,00

Cod.	203100	
FIN	Ø mm	20
A - B - C - D - W		44,20

Cod.	203001	
FIN	Ø mm	20
67		19,50
81		17,60

Cod.	523083	
FIN	Ø mm	20
67		2,00
81		2,00

Cod.	513035			513036			513037		
FIN	I - mm	100		150		200			
67	A - B - C - D - W	45,00		45,00		45,00			
81	A - B - C - D - W	38,70		38,70		38,70			



ALUMINIUM COLLECTION

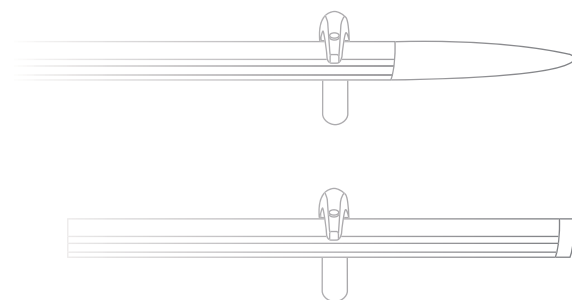

FIONA BASIC

FINITURE - FINISHES - FINITIONS - FERTIGUNGEN - ACABADOS - WYKOŃCZENIA

67	BNL	A1	A167	A181
81		A2	A267	A281
		A3	A367	A381
		A4	A467	A481



FIONA BASIC



Fin. 81

Alluminio satinato opaco
Satin mat aluminium
Aluminium satiné mat

Aluminium satiniert matt
Aluminio satinado mate
Aluminium satynowy matowy



Fin. A467

Grigio - Alluminio lucido
Gray - Bright aluminium
Gris - Aluminium poli

Grau - Aluminium poliert
Gris - Aluminio pulido
Szary - Aluminium polerowane

FIONA BASIC

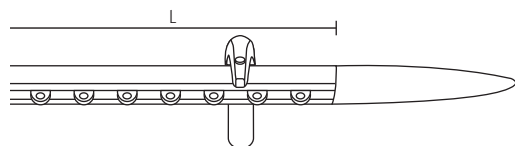

Scorritenda completo a parete
Complete curtain set
Tringle complète pose murale
Komplette Wandgarnitur
Conjunto completo a pared
Karnisz kompletny montaż do ściany

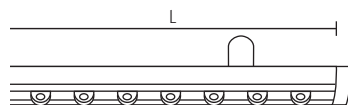

Scorritenda completo a soffitto
Complete curtain set with ceiling bracket
Tringle complète à plafond
Komplette Deckengarnitur
Conjunto completo a techo
Karnisz kompletny do sufitu

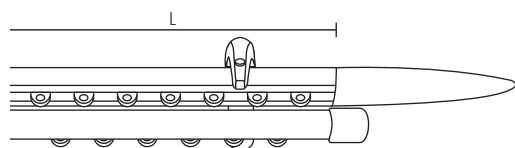

Scorritenda completo doppio a parete
Complete double curtain set
Tringle complète double pose murale
Komplette Doppelgarnitur
Conjunto completo doble a pared
Karnisz podwójny kompletny montaż do ściany

FIN. = Finitura - Finish - Finition - Fertigung - Acabado - Wykonczenie
Scor. = Scorrevoli - Runners - Glisseurs - Gleiter - Correderas - Ślizgacze
Sup. = Supporti - Brackets - Supports - Träger - Soportes - Wsporniki

Cod. 505E02

FIN	cm	120	140	160	180	200	220	250	300	340
67		295	316	335	355	376	442	474	523	562
81		280	300	318	336	355	419	448	494	530
BNL		295	316	335	355	376	442	474	523	562
A167 - A267 - A367 - A467		283	302	320	338	358	423	452	498	534
A181 - A281 - A381 - A481		280	300	318	336	355	419	448	494	530
Scor. Cod. 1012	n.	16	20	22	24	28	30	36	42	46
Sup. cm 9	n.	2	2	2	2	2	3	3	3	3

Cod. 505F02

FIN	cm	120	140	160	180	200	220	250	300	340
67		310	331	350	369	390	464	495	545	584
81		295	315	332	350	370	441	470	516	552
BNL		310	331	350	369	390	464	495	545	584
A167 - A267 - A367 - A467		297	317	335	353	372	444	474	520	555
A181 - A281 - A381 - A481		295	315	332	350	370	441	470	516	552
Scor. Cod. 1012	n.	16	20	22	24	28	30	36	42	46
Sup. cm 16	n.	2	2	2	2	2	3	3	3	3

Cod. 505T45

FIN	cm	120	140	160	180	200	220	250	300	340
67		204	225	244	263	284	320	352	401	440
81		190	209	227	245	265	299	329	374	410
BNL		204	225	244	263	284	320	352	401	440
A167 - A267 - A367 - A467		195	215	232	250	270	305	334	380	416
A181 - A281 - A381 - A481		190	209	227	245	265	299	329	374	410
Scor. Cod. 1012	n.	16	20	22	24	28	30	36	42	46
Sup. cm 2	n.	2	2	2	2	2	3	3	3	3

Cod. 505L02

FIN	cm	120	140	160	180	200	220	250	300	340
67		468	498	526	553	584	703	749	819	874
81		444	472	497	523	551	666	709	774	825
BNL		468	498	526	553	584	703	749	819	874
A167 - A267 - A367 - A467		452	480	505	531	559	677	719	784	835
A181 - A281 - A381 - A481		444	472	497	523	551	666	709	774	825
Scor. Cod. 1012	n.	16/16	20/20	22/22	24/24	28/28	30/30	36/36	42/42	46/46
Sup. cm 8	n.	2	2	2	2	2	3	3	3	3



FIONA BASIC

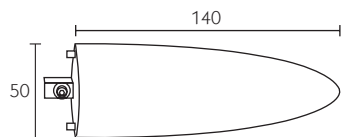

503002

Terminali
Finials
Embouts

Endstück
Terminals
Końcówka

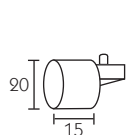

203145

Tappo
Endcap
Bouchon

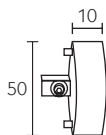

503045

Endkappe
Tapón
Zatyczka

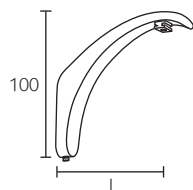

503---

Supporto
Bracket
Support
Träger
Soporte
Wspornik

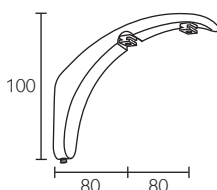

503117

Supporto doppio
Double bracket
Support double
Doppelträger
Soporte doble
Wspornik podwójny

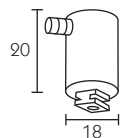

503295

Supporto a soffitto
Ceiling bracket
Support à plafond

Deckenträger
Soporte a techo
Wspornik do sufitu

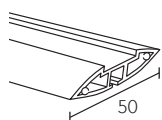

503100

Profilo
Profile
Profil

Profil
Perfil
Profil

Cod.	503002	
FIN		
67		40,90
81		39,10
BNL		40,90
A1 - A2 - A3 - A4		39,10

Cod.		203145	503045
FIN	Ø mm	20	50
67		15,50	25,40
81		13,60	22,80
BNL		15,50	25,40

Cod.		503109	503119	503117
FIN	l - mm	90	160	80
67		46,80	54,10	92,00
81		45,60	52,90	89,90
BNL		46,80	54,10	92,00

Cod.	503295	
FIN		
67		16,60
81		16,60
BNL		16,60

Cod.		503100
FIN	Ø mm	
67		89,00
81		81,80
BNL		89,00
A1 - A2 - A3 - A4		81,80



Components

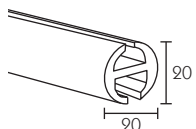

203200

Profilo
Profile
Profil

Profil
Perfil
Profil

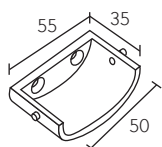

513201

Rosetta a muro
Recess bracket
Naissance murale

Wandlager
Soporte lateral
Podkładka do muru



1012

Scorrevole
Runner
Glisseur



1065

Gleiter
Corredera
Ślizgacze

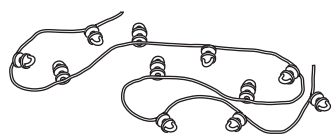

1065--

Scorrevoli
Runners
Glisseurs

Gleiter
Correderas
Ślizgacze

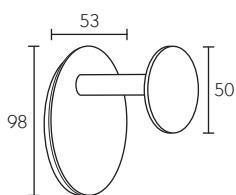

5130--

Fermatenda
Holdback
Porte-embrasse

Raffhalter
Alzapaño
Przytrzymanie firanki

Cod.		203200
FIN	Ø mm	20
67		32,00
81		28,80
BNL		32,00
A1 - A2 - A3 - A4		28,80

Cod.		513201
FIN		
67		30,00
81		27,20
BNL		30,00

Cod.	1012	1065
FIN		
	0,80	0,08

Cod.	1065P6*	1065P8**
FIN		
Euro/mt	6,74	6,74

* Scorrevoli passo 60 mm - Runners each 60 mm - Glisseurs tous les 60 mm - Gleiter je 60 mm - Correderas cada 60 mm - Ślizgi co 60 mm
** Scorrevoli passo 80 mm - Runners each 80 mm - Glisseurs tous les 80 mm - Gleiter je 80 mm - Correderas cada 80 mm - Ślizgi co 80 mm

Cod.		513078	513088	513098
FIN	l - mm	100	150	200
67		64,10	68,60	73,10
81		52,50	56,10	59,70
BNL		64,10	68,60	73,10
A167 - A267 - A367 - A467		64,10	68,60	73,10
A181 - A281 - A381 - A481		52,50	56,10	59,70



ALUMINIUM COLLECTION

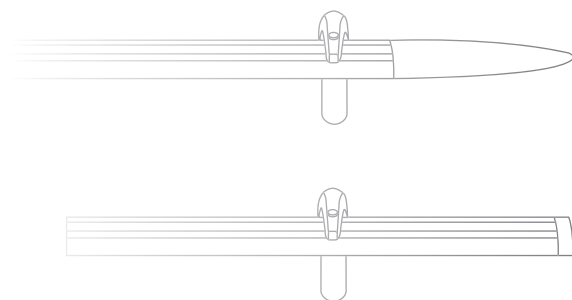

FIONA FLY

FINITURE - FINISHES - FINITIONS - FERTIGUNGEN - ACABADOS - WYKOŃCZENIA

67	67OR	A1	A167	A181
81		A2	A267	A281
		A3	A367	A381
		A4	A467	A481



FIONA FLY



Fin. 67
Alluminio lucido
Bright aluminium
Aluminium poli

Aluminium poliert
Aluminio pulido
Aluminium polerowane



Fin. A267
Tortora - Alluminio lucido
Dove-colored - Bright aluminium
Tourterelle - Aluminium poli

Turteltaubefarbe - Aluminium poliert
Tórtola - Aluminio pulido
Szaro-orzechowy - Aluminium polerowane

FIONA FLY

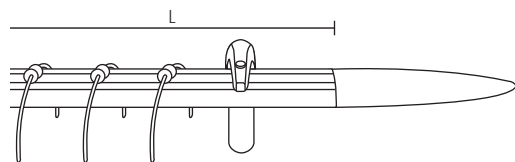

Scorritenda completo a parete
Complete curtain set
Tringle complète pose murale
Komplette Wandgarnitur
Conjunto completo a pared
Karnisz kompletny montaż do ściany

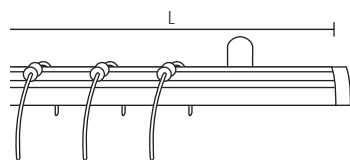

Scorritenda completo a soffitto
Complete curtain set with ceiling bracket
Tringle complète à plafond
Komplette Deckengarnitur
Conjunto completo a techo
Karnisz kompletny do sufitu

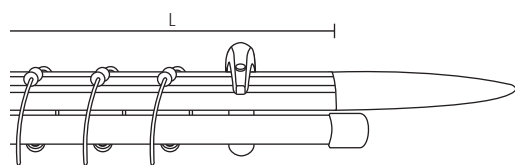

Scorritenda completo doppio a parete
Complete double curtain set
Tringle complète double pose murale
Komplette Doppelgarnitur
Conjunto completo doble a pared
Karnisz podwójny kompletny montaż do ściany

FIN. = Finitura - Finish - Finition - Fertigung - Acabado - Wykonczenie
An./ Scor. = Anelli / Scorrevoli - Rings / Runners - Anneaux / Glisseurs - Ringe / Gleiter - Anillas / Correderas - Kółka / Ślizgacze
Sup. = Supporti - Brackets - Supports - Träger - Soportes - Wsporniki

Cod. 505A02

FIN	cm	120	140	160	180	200	220	250	300	340
67		324	349	374	399	423	495	536	594	644
67OR		377	411	444	478	511	592	650	726	793
81		310	333	356	380	403	472	511	565	612
A167 - A267 - A367 - A467		312	335	359	382	405	476	514	569	616
A181 - A281 - A381 - A481		310	333	356	380	403	472	511	565	612
An.	n.	12	14	16	18	20	22	26	30	34
Sup. cm 9	n.	2	2	2	2	2	3	3	3	3

Cod. 505B02

FIN	cm	120	140	160	180	200	220	250	300	340
67		339	364	388	413	438	517	558	616	666
67OR		392	425	459	492	526	614	672	748	815
81		324	348	371	394	418	494	532	587	634
A167 - A267 - A367 - A467		327	350	373	397	420	497	536	591	638
A181 - A281 - A381 - A481		324	348	371	394	418	494	532	587	634
An.	n.	12	14	16	18	20	22	26	30	34
Sup. cm 16	n.	2	2	2	2	2	3	3	3	3

Cod. 505U45

FIN	cm	120	140	160	180	200	220	250	300	340
67		233	258	282	307	332	373	414	473	522
67OR		286	319	353	386	420	470	529	605	672
81		219	242	266	289	312	352	391	446	493
A167 - A267 - A367 - A467		224	248	271	294	318	358	396	451	498
A181 - A281 - A381 - A481		219	242	266	289	312	352	391	446	493
An.	n.	12	14	16	18	20	22	26	30	34
Sup. cm 2	n.	2	2	2	2	2	3	3	3	3

Cod. 505C02

FIN	cm	120	140	160	180	200	220	250	300	340
67		497	531	564	597	631	756	811	890	956
67OR		550	593	634	676	719	853	926	1.022	1.106
81		473	505	536	566	599	719	771	846	907
A167 - A267 - A367 - A467		481	513	544	574	607	730	782	856	917
A181 - A281 - A381 - A481		473	505	536	566	599	719	771	846	907
An. / Scor.	n.	12/16	14/20	16/22	18/24	20/28	22/30	26/36	30/42	34/46
Sup. cm 8	n.	2	2	2	2	2	3	3	3	3



FIONA FLY

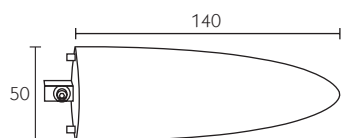

503002

Terminale
Finial
Embout

Endstück
Terminal
Końcówka

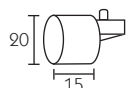

203145

Tappo
Endcap
Bouchon

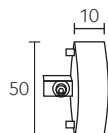

503045

Endkappe
Tapón
Zatyczka

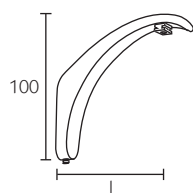

503---

Supporto
Bracket
Support
Träger
Soporte
Wspornik

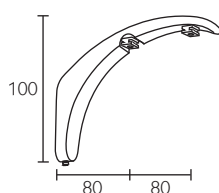

503117

Supporto doppio
Double bracket
Support double
Doppelträger
Soporte doble
Wspornik podwójny

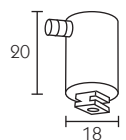

503295

Supporto a soffitto
Ceiling bracket
Support à plafond

Deckenträger
Soporte a techo
Wspornik do sufitu

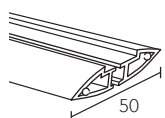

503200

Profilo
Profile
Perfil

Profil
Perfil
Profil

Cod.	503002
FIN	
67	40,90
81	39,10
A1 - A2 - A3 - A4	39,10

Cod.		203145	503045
FIN	Ø mm	20	50
67		15,50	25,40
81		13,60	22,80

Cod.		503109	503119	503117
FIN	l - mm	90	160	80
67		46,80	54,10	92,00
81		45,60	52,90	89,90

Cod.	503295
FIN	
67	16,60
81	16,60

Cod.	503200
FIN	
67	89,00
81	81,80
A1 - A2 - A3 - A4	81,80



Components

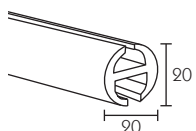

203200

Profilo
Profile
Profil

Profil
Perfil
Profil

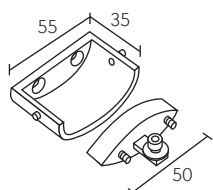

503001

Rosetta a muro
Recess bracket
Naissance murale

Wandlager
Soporte lateral
Podkładka do muru



1012

Scorrevole
Runner
Glisseur

Gleiter
Corredera
Slizgacze

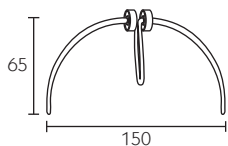

524028

Anelli
Rings
Anneaux

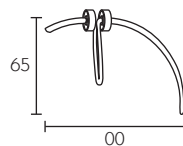

524029

Ringe
Anillas
Kółka

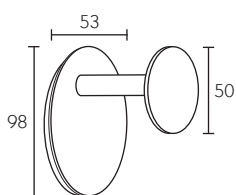

5130--

Fermatenda
Holdback
Porte-embrasse

Raffhalter
Alzapaño
Przytrzymanie firanki

Cod.		203200
FIN	Ø cm	20
67		32,00
81		28,80
A1 - A2 - A3 - A4		28,80

Cod.		503001
FIN		
67		40,70
81		36,90

Cod.		1012
FIN		0,80

Cod.		524028	524029
FIN			
67		3,50	3,50
81		3,50	3,50
67OR		7,90	7,90

Cod.		513078	513088	513098
FIN	l - mm	100	150	200
67		64,10	68,60	73,10
81		52,50	56,10	59,70
A167 - A267 - A367 - A467		64,10	68,60	73,10
A181 - A281 - A381 - A481		52,50	56,10	59,70



ALUMINIUM COLLECTION



116

FIORENZA

FINITURE - FINISHES - FINITIONS - FERTIGUNGEN - ACABADOS - WYKOŃCZENIA

25	A1	A125	A167
67	A2	A225	A267
	A3	A325	A367
	A4	A425	A467



FIORENZA



Fin. A425

Grigio - Alluminio colore acciaio satinato
Gray - Anodized aluminium steel color
Gris - Aluminium anodisé coloris acier

Grau - Aluminium eloxiert Stahl Farbe
Gris - Aluminium anodizado color acero
Szary - Aluminium w kolorze stali matowe



Fin. A125

Avorio - Alluminio colore acciaio satinato
Ivory - Anodized aluminium steel color
Ivoire - Aluminium anodisé coloris acier

Elfenbein - Aluminium eloxiert Stahl Farbe
Marfil - Aluminium anodizado color acero
Kość słoniowa - Aluminium w kolorze stali matowe

FIORENZA

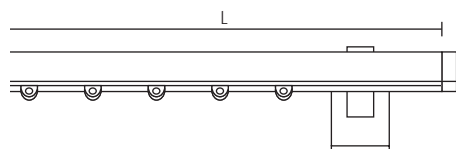

Scorritenda completo a parete
Complete curtain set
Tringle complète pose murale
Komplette Wandgarnitur
Conjunto completo a pared
Karnisz kompletny montaż do ściany

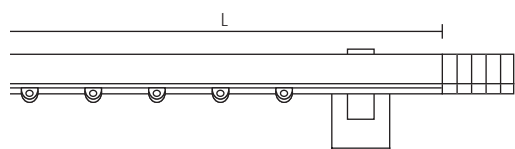

Scorritenda completo a parete
Complete curtain set
Tringle complète pose murale
Komplette Wandgarnitur
Conjunto completo a pared
Karnisz kompletny montaż do ściany

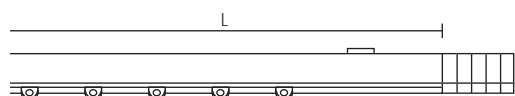

Scorritenda completo a soffitto
Complete curtain set with ceiling bracket
Tringle complète à plafond
Komplette Deckengarnitur
Conjunto completo a techo
Karnisz kompletny do sufitu

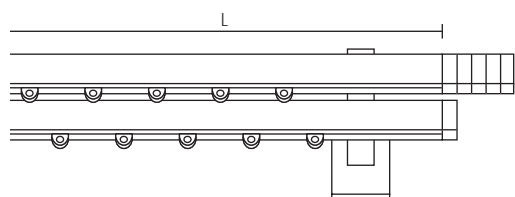

Scorritenda completo doppio a parete
Complete double curtain set
Tringle complète double pose murale
Komplette Doppelgarnitur
Conjunto completo doble a pared
Karnisz podwójny kompletny montaż do ściany



FIN. = Finitura - Finish - Finition - Fertigung - Acabado - Wykonczenie
Scor. = Scorrevoli - Runners - Glisseurs - Gleiter - Correderas - Ślizgacze
Sup. = Supporti - Brackets - Supports - Träger - Soportes - Wsporniki

Cod. 223A15

FIN	cm	120	140	160	180	200	220	250	300	340
A125 - A225 - A325 - A425		196	206	215	225	235	296	311	335	355
A167 - A267 - A367 - A467		209	219	229	239	249	315	330	354	374
Scor. Cod. 1000	n.	16	20	22	24	28	30	36	42	46
Sup. cm 9	n.	2	2	2	2	2	3	3	3	3

Cod. 223A05

FIN	cm	120	140	160	180	200	220	250	300	340
A125 - A225 - A325 - A425		277	287	297	307	317	377	392	417	437
A167 - A267 - A367 - A467		288	298	307	317	327	393	408	432	452
Scor. Cod. 1000	n.	16	20	22	24	28	30	36	42	46
Sup. cm 9	n.	2	2	2	2	2	3	3	3	3

Cod. 223S05

FIN	cm	120	140	160	180	200	220	250	300	340
A125 - A225 - A325 - A425		238	248	258	268	278	318	333	358	378
A167 - A267 - A367 - A467		244	254	264	274	284	328	343	367	387
Scor. Cod. 1000	n.	16	20	22	24	28	30	36	42	46
Sup.	n.	2	2	2	2	2	3	3	3	3

Cod. 223C05

FIN	cm	120	140	160	180	200	220	250	300	340
A125 - A225 - A325 - A425		413	433	453	473	493	584	614	663	702
A167 - A267 - A367 - A467		431	451	471	491	511	609	639	688	727
Scor. Cod. 1000	n.	16/16	20/20	22/22	24/24	28/28	30/30	36/36	42/42	46/46
Sup.	n.	2	2	2	2	2	3	3	3	3

Maggiorazione movimento a corda - Surcharge for corded systems - Supplément pour tirage
Zuschlag für Schnurbedienung - Suplemento por cuerda - Dodatkowo koszt mechanizmu

cm	120	140	160	180	200	220	250	300	340
	115	115	115	120	120	120	120	125	125



FIORENZA

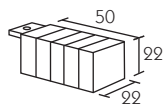

223101
 Terminale
 Finial
 Embout
 Endstück
 Terminal
 Końcówka

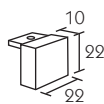

223145
 Tappo
 Endcap
 Bouchon
 Endkappe
 Tapón
 Zatyczka

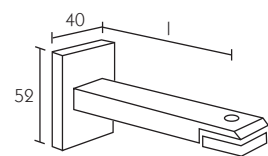

223418
 Supporto
 Bracket
 Support

Träger
 Soporte
 Wspornik

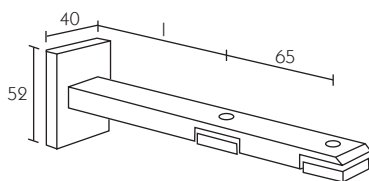

223417
 Supporto doppio
 Double bracket
 Support double

Doppelträger
 Soporte doble
 Wspornik podwójny



120

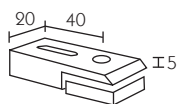

223997
 Supporto a soffitto
 Ceiling bracket
 Support à plafond

Deckenträger
 Soporte a techo
 Wspornik do sufitu

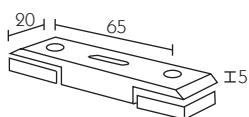

223998
 Supporto doppio a soffitto
 Double ceiling bracket
 Support à plafond double
 Decken-Doppelträger
 Soporte doble a techo
 Wspornik podwójny do sufitu

Cod.	223101	223145
FIN		
A125 - A225 - A325 - A425	58,50	
A167 - A267 - A367 - A467	58,50	
25		17,60
67		19,40

Cod.		223418	223428	223438
FIN	l - mm	90	160	210
25		50,60	57,30	64,00
67		55,70	63,00	70,40

Cod.		223417	223427
FIN	l - mm	90-160	160-210
25		71,40	77,60
67		78,60	85,40

Cod.	223997
FIN	
25	30,90
67	34,00

Cod.	223998
FIN	
25	43,30
67	47,60

Components

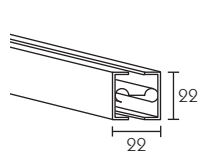

223110
 Profilo
 Profile
 Profil
 Profil
 Perfil
 Profil

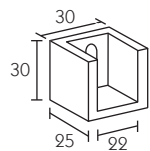

223001
 Rosetta a muro
 Recess bracket
 Naissance murale
 Wandlager
 Soporte lateral
 Podkładka do muru



1000
 Scorrevole
 Runner
 Glisseur



1001
 Gleiter
 Corredera
 Ślizgacze

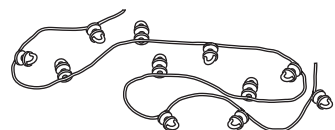

1000--
 Scorrevoli
 Runners
 Glisseurs

Gleiter
 Correderas
 Ślizgacze

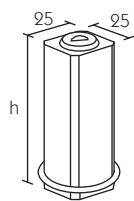

5630--
 Fiocco piatto
 Flat weight
 Contrepoids plat

Schnurbeschwerer
 Contrapeso plano
 Obciążnik płaski

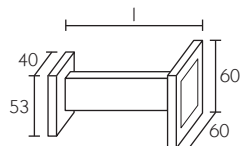

5130--
 Fermatenda
 Holdback
 Porte-embrasse

Raffhalter
 Alzapaño
 Przytrzymanie firanki

Cod.	223110	223001 SX / DX
FIN		
25		22,00
67		23,20
A1 - A2 - A3 - A4	48,30	

Cod.	1000	1001
FIN		
	0,08	0,61

Cod.	1000P6*	1000P8**
FIN		
Euro/mt	6,74	6,74

* Scorrevoli passo 60 mm - Runners each 60 mm - Glisseurs tous les 60 mm - Gleiter je 60 mm - Correderas cada 60 mm - Ślizgi co 60 mm
 ** Scorrevoli passo 80 mm - Runners each 80 mm - Glisseurs tous les 80 mm - Gleiter je 80 mm - Correderas cada 80 mm - Ślizgi co 80 mm

Cod.	563007	563008
FIN	h - mm	100
25	23,50	26,00
67	26,00	31,00

Cod.	513094	513095	513096
FIN	l - mm	150	200
A125 - A225 - A325 - A425	90,70	95,70	100,70
A167 - A267 - A367 - A467	98,30	103,90	109,50



ALUMINIUM COLLECTION

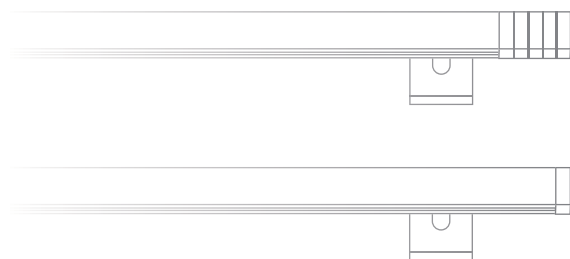

122

FRANCA

FINITURE - FINISHES - FINITIONS - FERTIGUNGEN - ACABADOS - WYKOŃCZENIA

25	A1	A125	A167
67	A2	A225	A267
	A3	A325	A367
	A4	A425	A467



FRANCA



Fin. A367

Beige - Alluminio lucido
Beige - Bright aluminium
Beige - Aluminium poli

Beige - Aluminium poliert
Beige - Aluminio pulido
Beige - Aluminium polerowane



Fin. A467

Grigio - Alluminio lucido
Gray - Bright aluminium
Gris - Aluminium poli

Grau - Aluminium poliert
Gris - Aluminio pulido
Szary - Aluminium polerowane

FRANCA

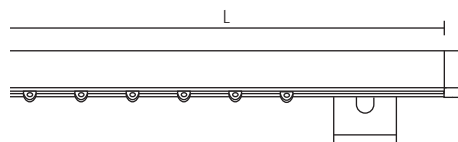

Scorritenda completo a parete
Complete curtain set
Tringle complète pose murale
Komplette Wandgarnitur
Conjunto completo a pared
Karnisz kompletny montaż do ściany

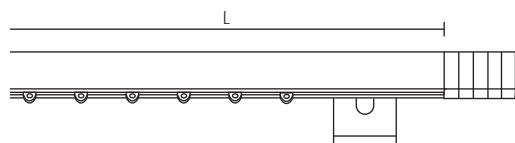

Scorritenda completo a parete
Complete curtain set
Tringle complète pose murale
Komplette Wandgarnitur
Conjunto completo a pared
Karnisz kompletny montaż do ściany

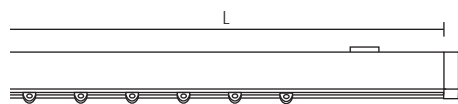

Scorritenda completo a soffitto
Complete curtain set with ceiling bracket
Tringle complète à plafond
Komplette Deckengarnitur
Conjunto completo a techo
Karnisz kompletny do sufitu

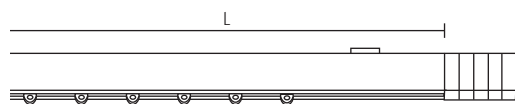

Scorritenda completo a soffitto
Complete curtain set with ceiling bracket
Tringle complète à plafond
Komplette Deckengarnitur
Conjunto completo a techo
Karnisz kompletny do sufitu

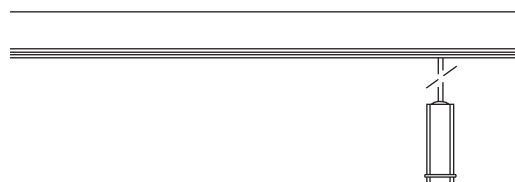

FIN. = Finitura - Finish - Finition - Fertigung - Acabado - Wykonczenie
Scor. = Scorrevoli - Runners - Glisseurs - Gleiter - Correderas - Ślizgacze
Sup. = Supporti - Brackets - Supports - Träger - Soportes - Wsporniki

Cod. 313A45

FIN	cm	120	140	160	180	200	220	250	300	340
A125 - A225 - A325 - A425		152	160	168	176	184	228	240	260	275
A167 - A267 - A367 - A467		172	180	188	196	204	256	268	287	303
Scor. Cod 1000	n.	16	20	22	24	28	30	36	42	46
Sup. cm 16	n.	2	2	2	2	2	3	3	3	3

Cod. 313A04

FIN	cm	120	140	160	180	200	220	250	300	340
A125 - A225 - A325 - A425		236	244	252	260	268	312	324	344	360
A167 - A267 - A367 - A467		253	261	269	276	284	336	348	368	384
Scor. Cod 1000	n.	16	20	22	24	28	30	36	42	46
Sup. cm 16	n.	2	2	2	2	2	3	3	3	3

Cod. 313T45

FIN	cm	120	140	160	180	200	220	250	300	340
A125 - A225 - A325 - A425		103	111	119	127	135	154	166	186	202
A167 - A267 - A367 - A467		107	115	123	130	138	158	170	190	205
Scor. Cod 1000	n.	16	20	22	24	28	30	36	42	46
Sup.	n.	2	2	2	2	2	3	3	3	3

Cod. 313T04

FIN	cm	120	140	160	180	200	220	250	300	340
A125 - A225 - A325 - A425		187	195	203	211	219	239	251	270	286
A167 - A267 - A367 - A467		187	195	203	211	219	239	251	270	286
Scor. Cod 1000	n.	16	20	22	24	28	30	36	42	46
Sup.	n.	2	2	2	2	2	3	3	3	3

Maggiorazione movimento a corda - Surcharge for corded systems - Supplément pour tirage
Zuschlag für Schnurbedienung - Suplemento por cuerda - Dodatkowo koszt mechanizmu

cm	120	140	160	180	200	220	250	300	340
	72	72	72	72	77	77	77	77	77



FRANCA

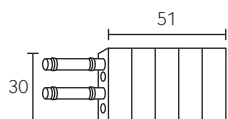

313004

Terminale
Finial
Embout

Endstück
Terminal
Końcówka

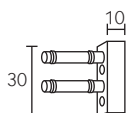

313045

Tappo
Endcap
Bouchon

Endkappe
Tapón
Zatyczka

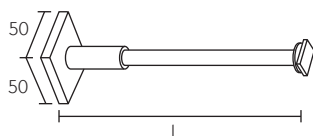

3133--

Supporto
Bracket
Support

Träger
Soporte
Wspornik



126

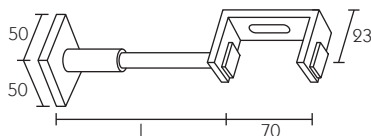

3134--

Supporto doppio
Double bracket
Support double

Doppelträger
Soporte doble
Wspornik podwójny

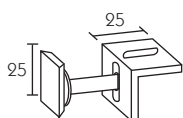

313598

Supporto a soffitto
Ceiling bracket
Support à plafond
Deckenträger
Soporte a techo
Wspornik do sufitu

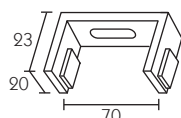

313587

Supporto doppio a soffitto
Double ceiling bracket
Support à plafond double
Decken-Doppelträger
Soporte doble a techo
Wspornik podwójny do sufitu

Cod.	313004SX / DX
FIN	
A125 - A225 - A325 - A425	58,50
A167 - A267 - A367 - A467	58,50

Cod.	313045SX / DX
FIN	
25	16,40
67	18,10

Cod.		313318	313328
FIN	l - mm	160	210
25		35,90	38,40
67		44,00	48,00

Cod.		313437	313447
FIN	l - mm	160	210
25		55,50	58,60
67		59,70	62,80

Cod.		313598	313587
FIN			
25		11,40	20,60
67		11,40	24,80

Components

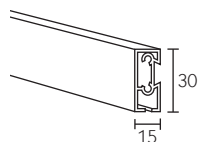

313300

Profilo
Profile
Profil
Profil
Perfil
Profil

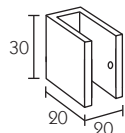

313003

Rosetta a muro
Recess bracket
Naissance murale
Wandlager
Soporte lateral
Podkładka do muru



1000

Scorrevole
Runner
Glisseur



1001

Gleiter
Corredera
Ślizgacze

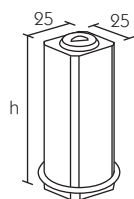

5630--

Fiocco piatto
Flat weight
Contrepoids plat

Schnurbeschwerer
Contrapeso plano
Obciążnik płaski

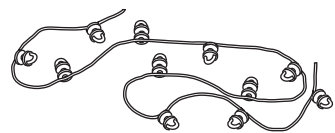

1000--

Scorrevoli
Runners
Glisseurs

Gleiter
Correderas
Ślizgacze

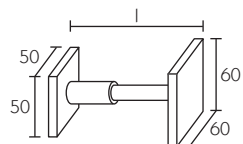

5130--

Fermatenda
Holdback
Porte-embrasse

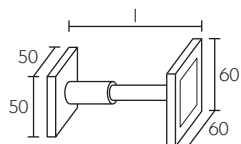

Fermatenda
Holdback
Porte-embrasse

Cod.	313300	313003SX / DX
FIN		
25		21,80
67		23,90
A1 - A2 - A3 - A4	38,60	

Cod.	1000	1001
FIN		
	0,08	0,61

Cod.	563007	563008
FIN	h - mm	100
25	23,50	26,00
67	26,00	31,00

Cod.	1000P6*	1000P8**
FIN		
Euro/mt	6,74	6,74

* Scorrevoli passo 60 mm - Runners each 60 mm - Glisseurs tous les 60 mm - Gleiter je 60 mm - Correderas cada 60 mm - Ślizgi co 60 mm
** Scorrevoli passo 80 mm - Runners each 80 mm - Glisseurs tous les 80 mm - Gleiter je 80 mm - Correderas cada 80 mm - Ślizgi co 80 mm

Cod.	513091	513092	513093
FIN	l - mm	150	200
25	53,00	57,00	61,00
67	58,30	62,80	67,30
A125 - A225 - A325 - A425	67,00	71,00	75,00
A167 - A267 - A367 - A467	72,30	76,80	81,30



ALUMINIUM COLLECTION

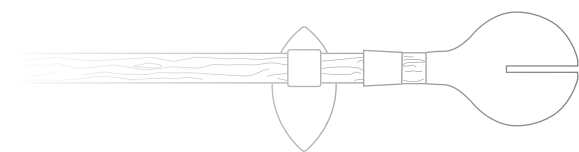

IRIS

FINITURE - FINISHES - FINITIONS - FERTIGUNGEN - ACABADOS - WYKOŃCZENIA

18	A	M
89	T	N
	W	





Fin. 18A

Nero base - Ciliegio
 Basic black - Cherry
 Noir base - Merisier

Grundschwarz - Kirschbaum
 Negro base - Cerezo
 Czarny podstawowy - Wiśnia



Fin. A



Fin. T



Fin. W

IRIS

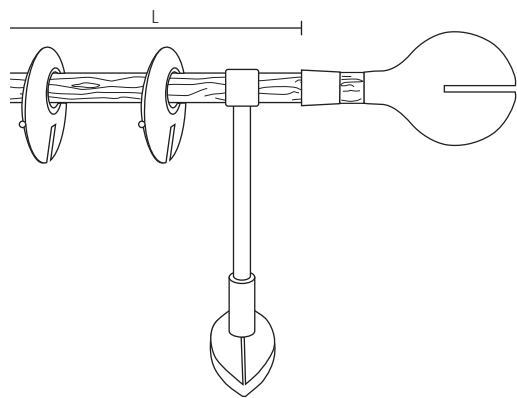

Scorritenda completo a parete
Complete curtain set
Tringle complète pose murale
Komplette Wandgarnitur
Conjunto completo a pared
Karnisz kompletny montaż do ściany

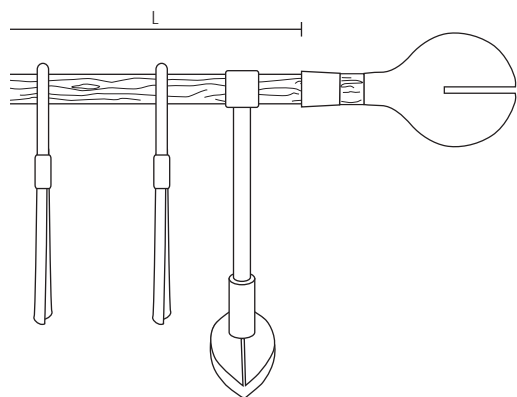

Scorritenda completo a parete
Complete curtain set
Tringle complète pose murale
Komplette Wandgarnitur
Conjunto completo a pared
Karnisz kompletny montaż do ściany

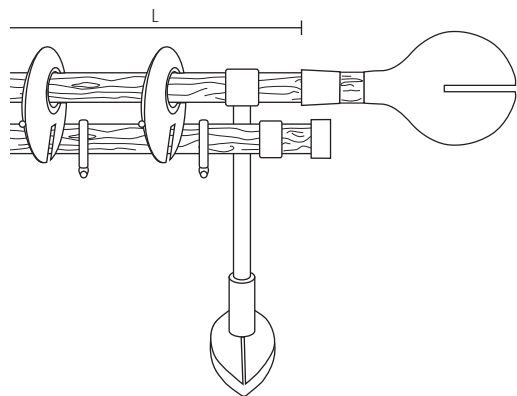

Scorritenda completo doppio a parete
Complete double curtain set
Tringle complète double pose murale
Komplette Doppelgarnitur
Conjunto completo doble a pared
Karnisz podwójny kompletny montaż do ściany

FIN. = Finitura - Finish - Finition - Fertigung - Acabado - Wykonczenie

An. = Anelli - Rings - Anneaux - Ringe - Anillas - Kółka

Sup. = Supporti - Brackets - Supports - Träger - Soportes - Wsporniki

Cod. 203A63

FIN	cm	120	140	160	180	200	220	250	300	340
18 A - T - W		288	325	334	372	409	447	489	568	615
89 A - T - W		302	343	352	393	435	472	517	604	654
An. Cod. 525008	n.	8	10	10	12	14	14	16	20	22
Sup. cm 16	n.	2	2	2	2	2	3	3	3	3

Cod. 203B63

FIN	cm	120	140	160	180	200	220	250	300	340
18 A - T - W		289	327	336	373	411	449	491	570	617
89 A - T - W		303	345	354	395	436	474	520	606	656
An. Cod. 525008	n.	8	10	10	12	14	14	16	20	22
Sup. cm 24	n.	2	2	2	2	2	3	3	3	3

Cod. 203E63

FIN	cm	120	140	160	180	200	220	250	300	340
18 A - T - W		283	310	337	365	392	447	497	556	611
89 A - T - W		283	310	337	365	392	447	497	556	611
An. Cod. 524041	n.	12	14	16	18	20	22	26	30	34
Sup. cm 16	n.	2	2	2	2	2	3	3	3	3

Cod. 203C63

FIN	cm	120	140	160	180	200	220	250	300	340
18 A - T - W		392	443	464	515	565	619	682	792	864
89 A - T - W		406	461	482	536	590	644	711	828	904
An. Cod. 525008 - 523083	n.	8/12	10/14	10/16	12/18	14/20	14/22	16/26	20/30	22/34
Sup. cm 16	n.	2	2	2	2	2	3	3	3	3



IRIS

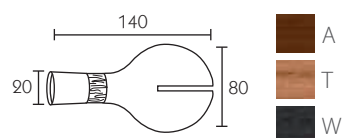

203063

Terminale
Finial
Embout

Endstück
Terminal
Końcówka

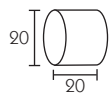

203045

Tappo
Endcap
Bouchon

Endkappe
Tapón
Zatyczka

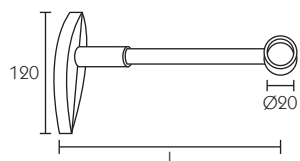

2035--

Supporto
Bracket
Support

Träger
Soporte
Wspornik



132

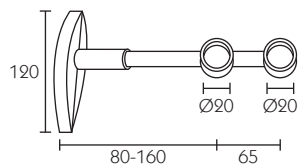

203517

Supporto doppio
Double bracket
Support double

Doppelträger
Soporte doble
Wspornik podwójny

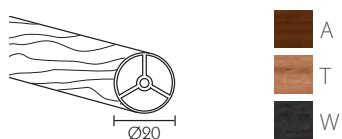

203100

Tubo in alluminio impiallacciato rovere
Aluminium pole oak wood coated
Tube en aluminium plaqué chêne
Alu Rohr ummantelt mit Holz
Tubo en aluminio recubierto en roble
Rura aluminiowa fornirowana dąb

Cod.		203063
FIN	Ø mm	20
18 A - T - W		31,40
89 A - T - W		31,40

Cod.		203045
FIN	Ø mm	20
18		10,00
89		10,00

Cod.		203518	203528
FIN	Ø mm	20	20
	l - mm	160	240
18		28,30	29,00
89		28,30	29,00

Cod.		203517
FIN	Ø mm	20/20
18		32,00
89		32,00

Cod.		203100
FIN	Ø mm	20
A - T - W		44,20

Components

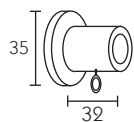

203001

Rosetta a muro
Recess bracket
Naissance murale

Wandlager
Soporte lateral
Podkładka do muru

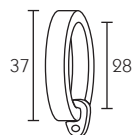

523083

Anello con guarnizione ed occhio in plastica
Ring with inlay and plastic eyelet
Anneau avec joint et oeillet plastique
Ring mit Gleitanlage und Faltenleghaken
Anilla con guarnición y ganchino en plástico
Kółko z wkładką teflonową i uchwytem plastikowym

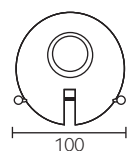

525008

Anello
Ring
Anneau

Ring
Anilla
Kółko

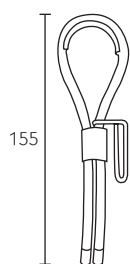

524041

Anello guardolo
Welt ring
Anneau lacet

Lederschlaufen
Anilla cordon
Kółko z rzemyka

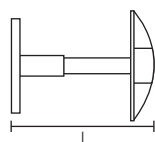

5130--

Fermatenda
Holdback
Porte-embrasse



Raffhalter
Alzapaño
Przytrzymanie firanki

Cod.		203001
FIN	Ø mm	20
18		17,60
89		17,60

Cod.		523083
FIN	Ø mm	20
18		2,00
89		2,00

Cod.		525008
FIN		
18		14,40
89		16,20

Cod.		524041
FIN	Ø mm	20
18 M - N		9,20
89 M - N		9,20

Cod.		513055	513036	513037
FIN	l - mm	100	150	200
18 A - T		46,20	49,80	53,40
89 A - T - W		46,20	49,80	53,40



ALUMINIUM COLLECTION

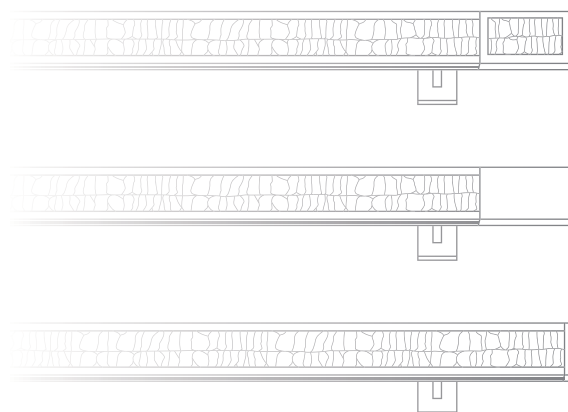

134

JANE

FINITURE - FINISHES - FINITIONS - FERTIGUNGEN - ACABADOS - WYKOŃCZENIA

67	BB	CB	SB
81	BC	CC	SC
	BM	CM	SM
	BN	CN	SN
	BR	CR	SR



Fin. | 67CM

JANE



Fin. 67SB

Alluminio lucido - Struzzo bianco
Bright aluminium - White ostrich
Aluminium poli - Autriche Blanche

Aluminium poliert - Weisser Strauss
Aluminio pulido - Avestruz blanco
Aluminium polerowane - Struś biała



Fin. 81BC

Alluminio satinato opaco - Bufalino marrone
Satin mat aluminium - Brown buff
Aluminium satiné mat - Buffle marron

Aluminium satiniert matt - Brauner Büffel
Aluminio satinado mate - Bufalino marrón
Aluminium satynowy matowy - Cielęca brązowa

JANE

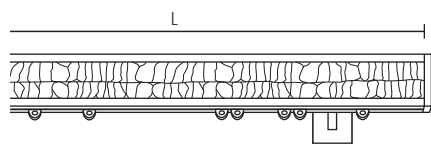

Scorritenda completo a parete
Complete curtain set
Tringle complète pose murale
Komplette Wandgarnitur
Conjunto completo a pared
Karnisz kompletny montaż do ściany

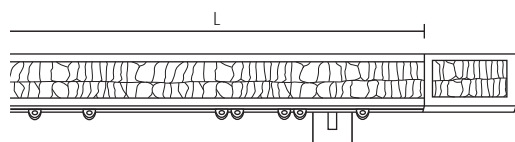

Scorritenda completo a parete
Complete curtain set
Tringle complète pose murale
Komplette Wandgarnitur
Conjunto completo a pared
Karnisz kompletny montaż do ściany

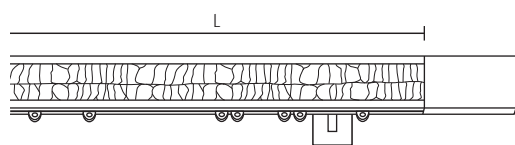

Scorritenda completo a parete
Complete curtain set
Tringle complète pose murale
Komplette Wandgarnitur
Conjunto completo a pared
Karnisz kompletny montaż do ściany

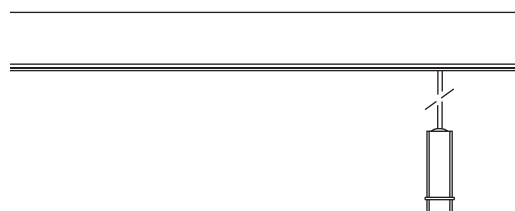

FIN. = Finitura - Finish - Finition - Fertigung - Acabado - Wykonczenie
Scor. = Scorrevoli - Runners - Glisseurs - Gleiter - Correderas - Ślizgacze
Sup. = Supporti - Brackets - Supports - Träger - Soportes - Wsporniki

Cod. 513S02A

FIN	cm	120	140	160	180	200	220	250	300	340
67 BB - BC - BM - BN - BR		254	269	284	298	313	327	415	451	479
67 CB - CC - CM - CN - CR		254	269	284	298	313	327	415	451	479
67 SB - SC - SM - SN - SR		254	269	284	298	313	327	415	451	479
81 BB - BC - BM - BN - BR		230	245	258	271	286	299	379	413	439
81 CB - CC - CM - CN - CR		230	245	258	271	286	299	379	413	439
81 SB - SC - SM - SN - SR		230	245	258	271	286	299	379	413	439
Scor. Cod. 1012	n.	16	20	22	24	28	30	36	42	46
Sup. cm 9	n.	2	2	2	2	2	2	3	3	3

Cod. 513S02B

FIN	cm	120	140	160	180	200	220	250	300	340
67 BB - BC - BM - BN - BR		308	324	338	352	367	381	469	505	533
67 CB - CC - CM - CN - CR		308	324	338	352	367	381	469	505	533
67 SB - SC - SM - SN - SR		308	324	338	352	367	381	469	505	533
81 BB - BC - BM - BN - BR		283	297	310	324	338	351	432	465	491
81 CB - CC - CM - CN - CR		283	297	310	324	338	351	432	465	491
81 SB - SC - SM - SN - SR		283	297	310	324	338	351	432	465	491
Scor. Cod. 1012	n.	16	20	22	24	28	30	36	42	46
Sup. cm 9	n.	2	2	2	2	2	2	3	3	3

Cod. 513S02C

FIN	cm	120	140	160	180	200	220	250	300	340
67 BB - BC - BM - BN - BR		300	315	329	343	359	373	460	496	524
67 CB - CC - CM - CN - CR		300	315	329	343	359	373	460	496	524
67 SB - SC - SM - SN - SR		300	315	329	343	359	373	460	496	524
81 BB - BC - BM - BN - BR		278	292	305	318	333	346	426	460	486
81 CB - CC - CM - CN - CR		278	292	305	318	333	346	426	460	486
81 SB - SC - SM - SN - SR		278	292	305	318	333	346	426	460	486
Scor. Cod. 1012	n.	16	20	22	24	28	30	36	42	46
Sup. cm 9	n.	2	2	2	2	2	2	3	3	3

Maggiorazione movimento a corda - Surcharge for corded systems - Supplément pour tirage
Zuschlag für Schnurbedienung - Suplemento por cuerda - Dodatkowo koszt mechanizmu

cm	120	140	160	180	200	220	250	300	340
	72	72	72	72	77	77	77	77	77



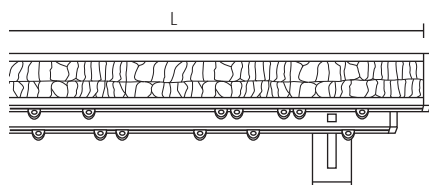

Scorritenda completo doppio a parete
Complete double curtain set
Tringle complète double pose murale
Komplette Doppelgarnitur
Conjunto completo doble a pared
Karnisz podwójny kompletny montaż do ściany

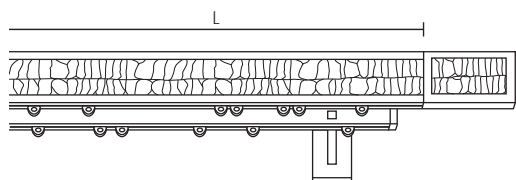

Scorritenda completo doppio a parete
Complete double curtain set
Tringle complète double pose murale
Komplette Doppelgarnitur
Conjunto completo doble a pared
Karnisz podwójny kompletny montaż do ściany

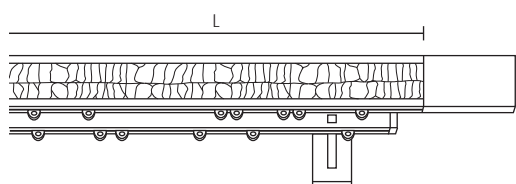

Scorritenda completo doppio a parete
Complete double curtain set
Tringle complète double pose murale
Komplette Doppelgarnitur
Conjunto completo doble a pared
Karnisz podwójny kompletny montaż do ściany

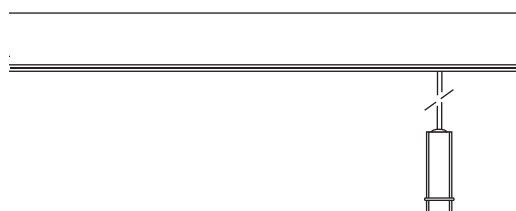

FIN. = Finitura - Finish - Finition - Fertigung - Acabado - Wykonczenie
Scor. = Scorrevoli - Runners - Glisseurs - Gleiter - Correderas - Ślizgacze
Sup. = Supporti - Brackets - Supports - Träger - Soportes - Wsporniki

Cod. 513U02A

FIN	cm	120	140	160	180	200	220	250	300	340
67 BB - BC - BM - BN - BR		350	375	396	417	441	462	574	628	670
67 CB - CC - CM - CN - CR		350	375	396	417	441	462	574	628	670
67 SB - SC - SM - SN - SR		350	375	396	417	441	462	574	628	670
81 BB - BC - BM - BN - BR		321	343	362	381	403	421	526	575	612
81 CB - CC - CM - CN - CR		321	343	362	381	403	421	526	575	612
81 SB - SC - SM - SN - SR		321	343	362	381	403	421	526	575	612
Scor. Cod. 1012	n.	16/16	20/20	22/22	24/24	28/28	30/30	36/36	42/42	46/46
Sup. cm 8	n.	2	2	2	2	2	2	3	3	3

Cod. 513U02B

FIN	cm	120	140	160	180	200	220	250	300	340
67 BB - BC - BM - BN - BR		405	429	450	471	495	516	628	682	724
67 CB - CC - CM - CN - CR		405	429	450	471	495	516	628	682	724
67 SB - SC - SM - SN - SR		405	429	450	471	495	516	628	682	724
81 BB - BC - BM - BN - BR		374	396	414	433	455	474	579	627	664
81 CB - CC - CM - CN - CR		374	396	414	433	455	474	579	627	664
81 SB - SC - SM - SN - SR		374	396	414	433	455	474	579	627	664
Scor. Cod. 1012	n.	16/16	20/20	22/22	24/24	28/28	30/30	36/36	42/42	46/46
Sup. cm 8	n.	2	2	2	2	2	2	3	3	3

Cod. 513U02C

FIN	cm	120	140	160	180	200	220	250	300	340
67 BB - BC - BM - BN - BR		396	420	441	462	487	508	619	674	716
67 CB - CC - CM - CN - CR		396	420	441	462	487	508	619	674	716
67 SB - SC - SM - SN - SR		396	420	441	462	487	508	619	674	716
81 BB - BC - BM - BN - BR		368	390	409	428	450	469	573	622	659
81 CB - CC - CM - CN - CR		368	390	409	428	450	469	573	622	659
81 SB - SC - SM - SN - SR		368	390	409	428	450	469	573	622	659
Scor. Cod. 1012	n.	16/16	20/20	22/22	24/24	28/28	30/30	36/36	42/42	46/46
Sup. cm 8	n.	2	2	2	2	2	2	3	3	3

Maggiorazione movimento a corda - Surcharge for corded systems - Supplément pour tirage
Zuschlag für Schnurbedienung - Suplemento por cuerda - Dodatkowo koszt mechanizmu

cm	120	140	160	180	200	220	250	300	340
	72	72	72	72	77	77	77	77	77

Components

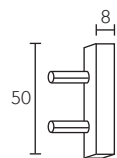

513041A

Terminale
Fial
Embout

Endstück
Terminal
Końcówka

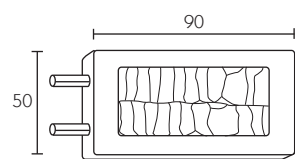

513041B

Terminale
Fial
Embout

Endstück
Terminal
Końcówka

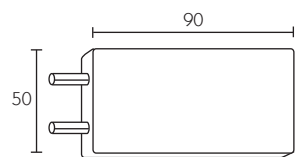

513041C

Terminale
Fial
Embout

Endstück
Terminal
Końcówka

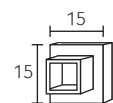

513045

Tappo
Endcap
Bouchon

Endkappe
Tapón
Zatyczka

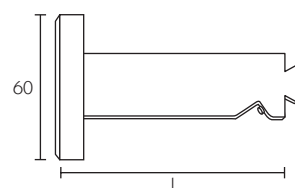

5132--

Supporto
Bracket
Support

Träger
Soporte
Wspornik

Cod.	513041A		
FIN			
67		19,30	
81		16,00	

Cod.	513041B		
FIN			
67 BB - BC - BM - BN - BR		46,40	
67 CB - CC - CM - CN - CR		46,40	
67 SB - SC - SM - SN - SR		46,40	
81 BB - BC - BM - BN - BR		42,20	
81 CB - CC - CM - CN - CR		42,20	
81 SB - SC - SM - SN - SR		42,20	

Cod.	513041C		
FIN			
67		42,20	
81		39,60	

Cod.	513045		
FIN			
67		14,20	
81		13,30	

Cod.		513218	513228	513238
FIN	l - mm	90	160	210
67		63,90	68,10	75,50
81		58,40	64,10	71,90



JANE

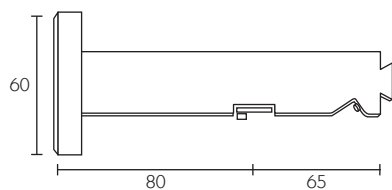

513217

Supporto doppio
Double bracket
Support double

Doppelträger
Soporte doble
Wspornik podwójny

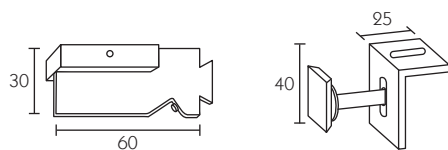

513518

Support a soffitto
Ceiling bracket
Support à plafond

513598

Deckenträger
Soporte a techo
Wspornik do sufitu

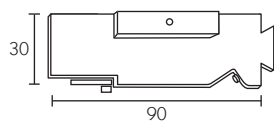

513517

Supporto doppio a soffitto
Double ceiling bracket
Support à plafond double
Decken-Doppelträger
Soporte doble a techo
Wspornik podwójny do sufitu



140

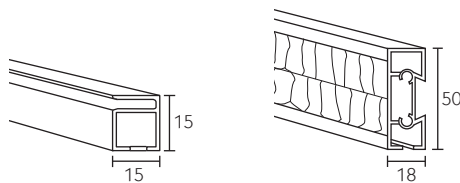

153200

Profilo
Profile
Profil

513100

Profil
Perfil
Profil

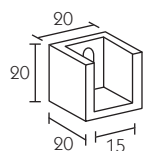

153001

Rosetta a muro
Recess bracket
Naissance murale

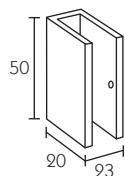

513125

Wandlager
Soporte lateral
Podkładka do muru

Cod.	513217
FIN	
67	75,50
81	71,90

Cod.	513518	513598
FIN		
67	62,80	11,40
81	58,40	11,40

Cod.	513517
FIN	
67	68,10
81	64,10

Cod.	153200	513100
FIN		
67	26,80	
81	20,40	
67 BB - BC - BM - BN - BR		62,20
67 CB - CC - CM - CN - CR		62,20
67 SB - SC - SM - SN - SR		62,20
81 BB - BC - BM - BN - BR		57,30
81 CB - CC - CM - CN - CR		57,30
81 SB - SC - SM - SN - SR		57,30

Cod.	153001SX / DX	513125SX / DX
FIN		
67	22,50	25,50
81	18,40	21,00

Components

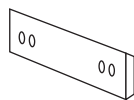

568030

Giunzione
Junction
Jonction

Verbinder
Enchufe
Łącznik



1012

Scorrevole
Runner
Glisseur



1065

Gleiter
Corredera
Ślizgacze

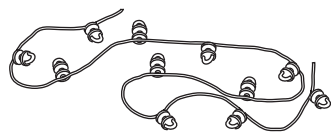

1065--

Scorrevoli
Runners
Glisseurs

Gleiter
Correderas
Ślizgacze

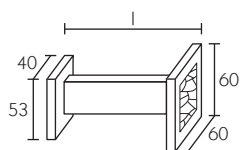

5130--

Fermatenda
Holdback
Porte-embrasse

Raffhalter
Alzapaño
Przytrzymanie franki

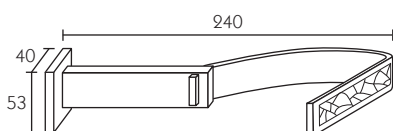

513058

Fermatenda bracciale
Tieback
Porte-embrasse-patère

Umfassender Raffhalter
Alzapaño
Przytrzymanie firany

Cod.	568030	
FIN	19,20	

Cod.	1012	1065
FIN	0,80	0,08

Cod.	1065P6*	10658**
FIN		
Euro/mt	6,74	6,74

* Scorrevoli passo 60 mm - Runners each 60 mm - Glisseurs tous les 60 mm - Gleiter je 60 mm - Correderas cada 60 mm - Ślizgi co 60 mm
** Scorrevoli passo 80 mm - Runners each 80 mm - Glisseurs tous les 80 mm - Gleiter je 80 mm - Correderas cada 80 mm - Ślizgi co 80 mm

Cod.	513094	513095	513096
FIN	100	150	200
67 BB - BC - BM - BN - BR	96,30	101,90	107,50
67 CB - CC - CM - CN - CR	96,30	101,90	107,50
67 SB - SC - SM - SN - SR	96,30	101,90	107,50
81 BB - BC - BM - BN - BR	81,00	85,50	90,00
81 CB - CC - CM - CN - CR	81,00	85,50	90,00
81 SB - SC - SM - SN - SR	81,00	85,50	90,00

Cod.	513058
FIN	
67 BB - BC - BM - BN - BR	125,90
67 CB - CC - CM - CN - CR	125,90
67 SB - SC - SM - SN - SR	125,90
81 BB - BC - BM - BN - BR	114,60
81 CB - CC - CM - CN - CR	114,60
81 SB - SC - SM - SN - SR	114,60



ALUMINIUM COLLECTION

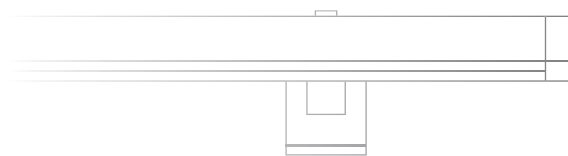

142

KETTY

FINITURE - FINISHES - FINITIONS - FERTIGUNGEN - ACABADOS - WYKOŃCZENIA

25	125	BNL	A2	A225	A267
67	267	2BNL	A3	A325	A367
		6BNL			





Fin. A225

Tortora - Alluminio colore acciaio satinato
Dove-colored - Anodized aluminium steel color
Tourterelle - Aluminium anodisé coloris acier

Turteltaubefarbe - Aluminium eloxiert Stahl Farbe
Tórtola - Aluminio anodizado color acero
Szaro-orzechowy - Aluminium w kolorze stali matowe



Fin. 125

Alluminio colore acciaio satinato - Alluminio lucido
Anodized aluminium steel color - Bright aluminium
Aluminium anodisé coloris acier - Aluminium poli

Aluminium eloxiert Stahl Farbe - Aluminium poliert
Aluminio anodizado color acero - Aluminio pulido
Aluminium w kolorze stali matowe - Aluminium polerowane

KETTY

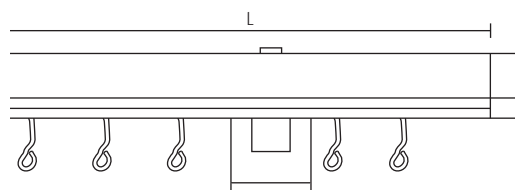

Scorritenda completo a parete
Complete curtain set
Tringle complète pose murale
Komplette Wandgarnitur
Conjunto completo a pared
Karnisz kompletny montaż do ściany

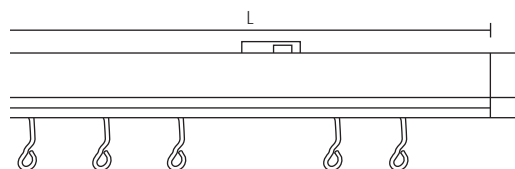

Scorritenda completo a soffitto
Complete curtain set with ceiling bracket
Tringle complète à plafond
Komplette Deckengarnitur
Conjunto completo a techo
Karnisz kompletny do sufitu

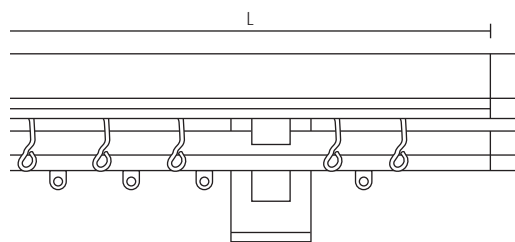

Scorritenda completo doppio a parete
Complete double curtain set
Tringle complète double pose murale
Komplette Doppelgarnitur
Conjunto completo doble a pared
Karnisz podwójny kompletny montaż do ściany

FIN. = Finitura - Finish - Finition - Fertigung - Acabado - Wykonczenie
Scor. = Scorrevoli - Runners - Glisseurs - Gleiter - Correderas - Ślizgacze
Sup. = Supporti - Brackets - Supports - Träger - Soportes - Wsporniki

Cod. 443K02

FIN	cm	160	180	200	220	250	300	340
25		257	272	287	350	374	409	439
67		288	304	321	390	417	455	488
125		277	292	307	374	399	434	464
267		269	285	301	365	392	431	463
2BNL		269	285	301	365	392	431	463
6BNL		288	304	321	390	417	455	488
A225 - A325		257	272	287	350	374	409	439
A267 - A367		277	292	307	374	399	434	464
Scor	n.	16	18	20	22	26	30	34
Sup. cm 9,5	n.	2	2	2	3	3	3	3

Cod. 443J02

FIN	cm	160	180	200	220	250	300	340
25		269	284	299	368	393	428	457
67		301	317	333	408	435	474	506
125		289	304	319	393	418	452	482
267		281	297	313	384	411	449	482
2BNL		281	297	313	384	411	449	482
6BNL		301	317	333	408	435	474	506
A225 - A325		269	284	299	368	393	428	457
A267 - A367		289	304	319	393	418	452	482
Scor	n.	16	18	20	22	26	30	34
Sup. cm 16	n.	2	2	2	3	3	3	3

Cod. 443Z02

FIN	cm	160	180	200	220	250	300	340
25		166	181	196	213	238	273	303
67		188	204	220	239	266	304	337
125		176	191	206	223	248	283	313
267		178	194	210	229	256	294	327
2BNL		178	194	210	229	256	294	327
6BNL		188	204	220	239	266	304	337
A225 - A325		166	181	196	213	238	273	303
A267 - A367		176	191	206	223	248	283	313
Scor	n.	16	18	20	22	26	30	34
Sup.	n.	2	2	2	3	3	3	3

Cod. 443W02

FIN	cm	160	180	200	220	250	300	340
25		358	379	401	481	517	566	608
67		402	425	450	538	578	634	681
125		380	401	423	508	544	594	635
267		380	403	428	511	550	607	654
2BNL		380	403	428	511	550	607	654
6BNL		402	425	450	538	578	634	681
A225 - A325		358	379	401	481	517	566	608
A267 - A367		380	401	423	508	544	594	635
Scor	n.	16/22	18/24	20/28	22/30	26/36	30/42	34/46
Sup. cm 9,5	n.	2	2	2	3	3	3	3



KETTY

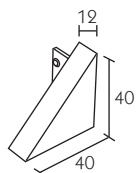

443002

Terminale
Finial
Embout

Endstück
Terminal
Końcówka

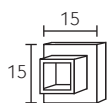

513045

Tappo
Endcap
Bouchon

Endkappe
Tapón
Zatyczka

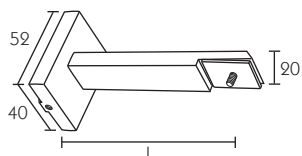

4431--

Supporto
Bracket
Support

Träger
Soporte
Wspornik

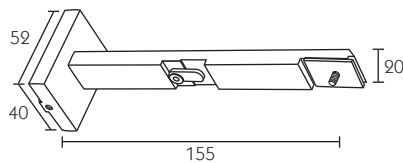

443117

Supporto doppio
Double bracket
Support double

Doppelträger
Soporte doble
Wspornik podwójny



443298

Supporto a soffitto
Ceiling bracket
Support à plafond

Deckenträger
Soporte a techo
Wspornik do sufitu

Cod.	443002
FIN	
25	21,20
67	26,10
BNL	26,10
A2 - A3	21,20

Cod.	513045
FIN	
25	14,20
67	14,20
BNL	14,20
A2 - A3	14,20

Cod.		443109	443119	443129
FIN	l - mm	95	160	210
25		47,70	53,80	60,00
67		52,60	58,80	65,90

Cod.	443117
FIN	mm
25	59,00
67	64,90

Cod.	443298
FIN	
	2,30



Components

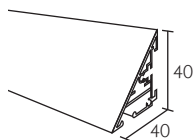

453100

Profilo
Profile
Profil

Profil
Perfil
Profil

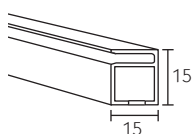

153200

Profilo
Profile
Profil
Profil
Perfil
Profil

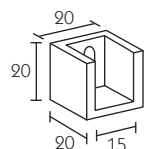

153001

Rosetta a muro
Recess bracket
Naissance murale
Wandlager
Soporte lateral
Podkładka do muru



524056

Scorrevole
Runner
Glisseurs



1012

Gleiter
Corredera
Slizgacze

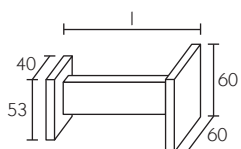

5130--

Ferमतenda
Holdback
Porte-embrasse

Raffhalter
Alzapaño
Przytrzymanie firanki

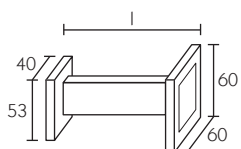

5130--

Ferमतenda
Holdback
Porte-embrasse

Raffhalter
Alzapaño
Przytrzymanie firanki

Cod.	453100
FIN	
25	50,10
67	57,20
BNL	57,20
A2 - A3	50,10

Cod.	153200	153001SX / DX
FIN		
25	20,40	20,40
67	26,80	22,50
BNL	26,80	22,50
A2 - A3	20,40	

Cod.	524056	1012
FIN		
98	2,45	0,80

Cod.		513031	513032	513033
FIN	mm	100	150	200
25		76,70	81,70	86,70
67		84,30	89,90	95,50
BNL		84,30	89,90	95,50
A2 - A3		76,70	81,70	86,70

Cod.		513094	513095	513096
FIN	I - mm	100	150	200
2BNL		90,70	95,70	100,70
6BNL		98,30	103,90	109,50
A225 - A325		90,70	95,70	100,70
A267 - A367		98,30	103,90	109,50



ALUMINIUM COLLECTION

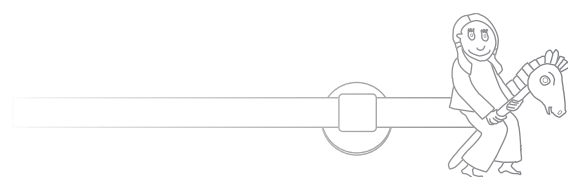
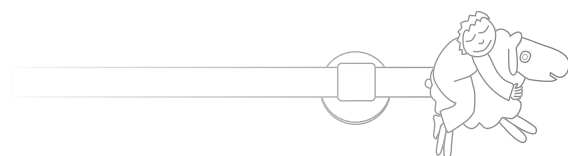
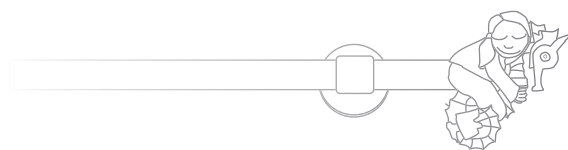

LILI & LEO

FINITURE - FINISHES - FINITIONS - FERTIGUNGEN - ACABADOS - WYKOŃCZENIA

831	835
832	836
833	837
834	



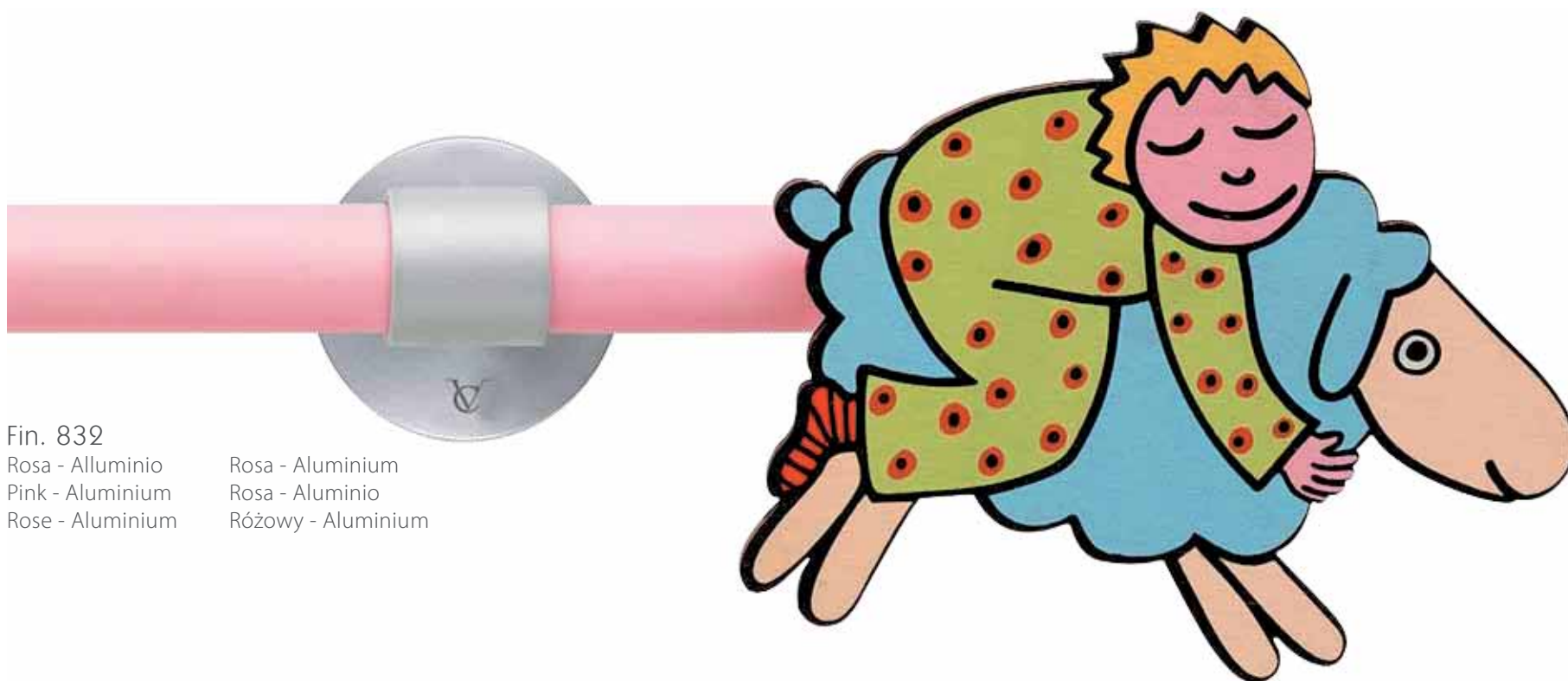

Fin. 832

Rosa - Alluminio
 Pink - Aluminium
 Rose - Aluminium

Rosa - Aluminium
 Rosa - Aluminio
 Różowy - Aluminium

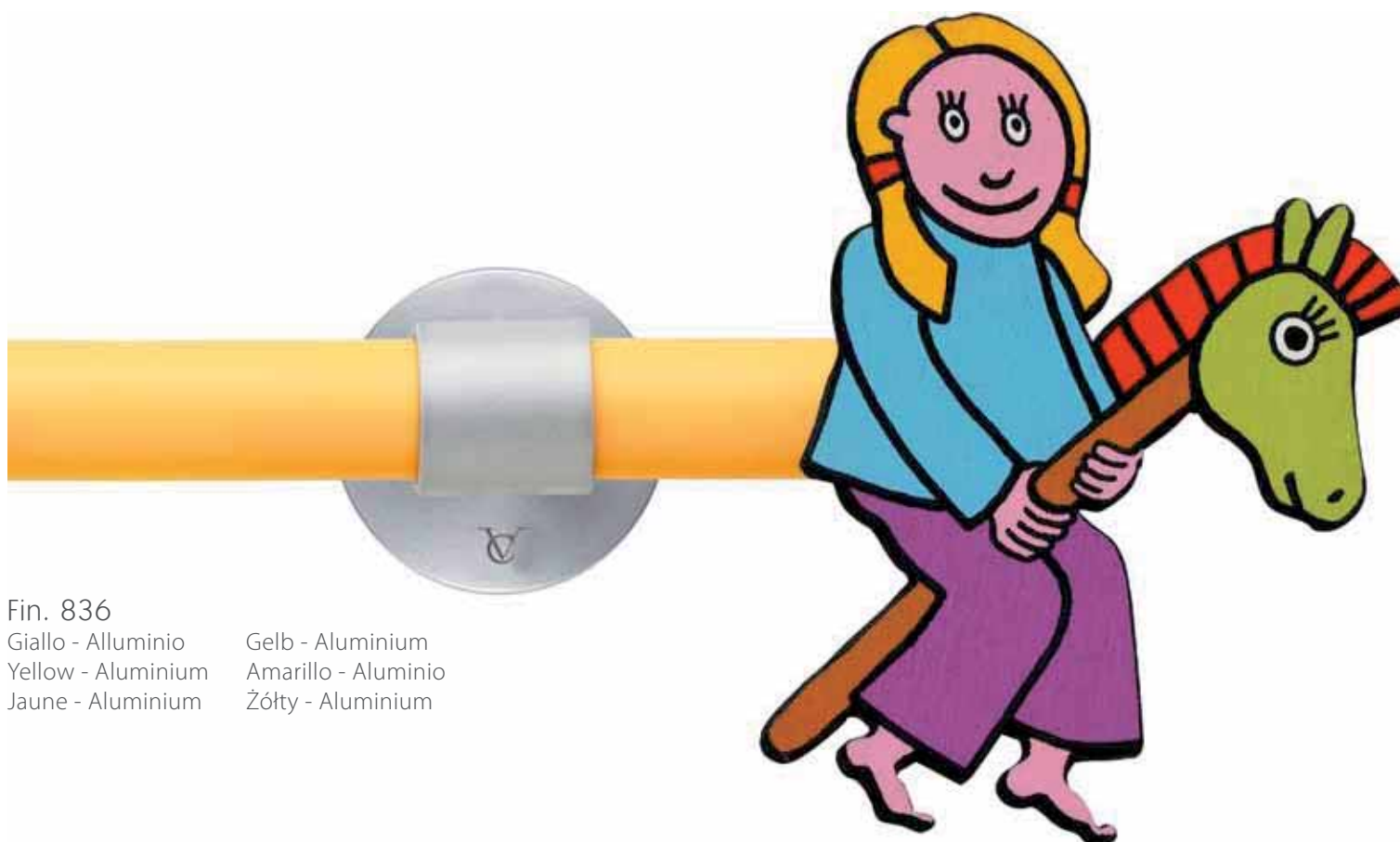

Fin. 836

Giallo - Alluminio
 Yellow - Aluminium
 Jaune - Aluminium

Gelb - Aluminium
 Amarillo - Aluminio
 Żółty - Aluminium

LILI & LEO

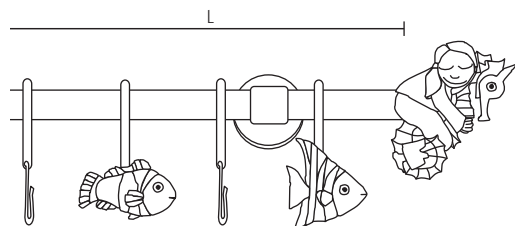

Scorritenda completo a parete
Complete curtain set
Tringle complète pose murale
Komplette Wandgarnitur
Conjunto completo a pared
Karnisz kompletny montaż do ściany

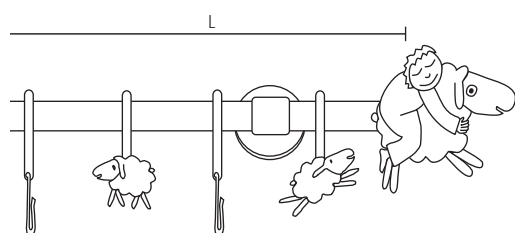

Scorritenda completo a parete
Complete curtain set
Tringle complète pose murale
Komplette Wandgarnitur
Conjunto completo a pared
Karnisz kompletny montaż do ściany

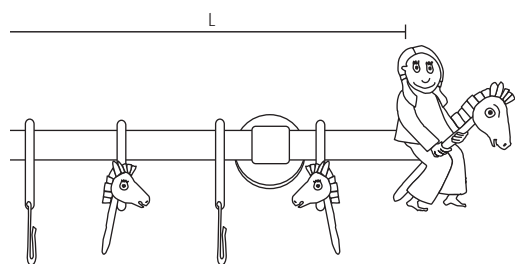

Scorritenda completo a parete
Complete curtain set
Tringle complète pose murale
Komplette Wandgarnitur
Conjunto completo a pared
Karnisz kompletny montaż do ściany

FIN. = Finitura - Finish - Finition - Fertigung - Acabado - Wykonczenie
An. = Anelli - Rings - Anneaux - Ringe - Anillas - Kółka
Sup. = Supporti - Brackets - Supports - Träger - Soportes - Wsporniki

Cod. 207A74F

FIN	cm	120	140	160	180	200	250	300	340
831 - 832 - 833 - 834		172	186	201	215	229	298	328	357
835 - 836 - 837		172	186	201	215	229	298	328	357
An.*	n.	6/6	7/7	8/8	9/9	10/10	13/13	15/15	17/17
Sup. cm 16	n.	2	2	2	2	2	3	3	3

* Gli anelli con e senza personaggi sono alternati - The rings with and without character are alternate - Les anneaux avec et sans personnage sont alternatifs
Ringe ohne oder mit Figur sind abwechselnd - Las anillas con y sin figuritas son alternadas - Kółka z i bez figurek są przemienne

Cod. 207A74P

FIN	cm	120	140	160	180	200	250	300	340
831 - 832 - 833 - 834		172	186	201	215	229	298	328	357
835 - 836 - 837		172	186	201	215	229	298	328	357
An.*	n.	6/6	7/7	8/8	9/9	10/10	13/13	15/15	17/17
Sup. cm 16	n.	2	2	2	2	2	3	3	3

* Gli anelli con e senza personaggi sono alternati - The rings with and without character are alternate - Les anneaux avec et sans personnage sont alternatifs
Ringe ohne oder mit Figur sind abwechselnd - Las anillas con y sin figuritas son alternadas - Kółka z i bez figurek są przemienne

Cod. 207A74C

FIN	cm	120	140	160	180	200	250	300	340
831 - 832 - 833 - 834		172	186	201	215	229	298	328	357
835 - 836 - 837		172	186	201	215	229	298	328	357
An.*	n.	6/6	7/7	8/8	9/9	10/10	13/13	15/15	17/17
Sup. cm 16	n.	2	2	2	2	2	3	3	3

* Gli anelli con e senza personaggi sono alternati - The rings with and without character are alternate - Les anneaux avec et sans personnage sont alternatifs
Ringe ohne oder mit Figur sind abwechselnd - Las anillas con y sin figuritas son alternadas - Kółka z i bez figurek są przemienne



LILI & LEO

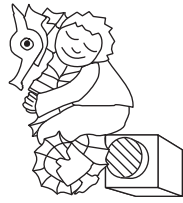

207074FSX
Terminale
Finial
Embout

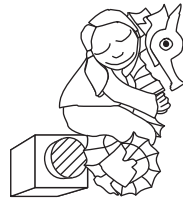

207074FDX
Endstück
Terminal
Końcówka



207074PSX
Terminale
Finial
Embout



207074PDX
Endstück
Terminal
Końcówka



152

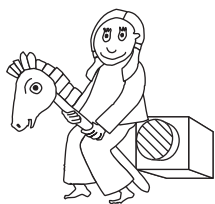

207074CSX
Terminale
Finial
Embout

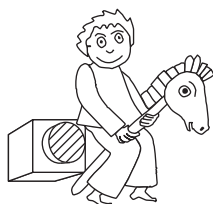

207074CDX
Endstück
Terminal
Końcówka

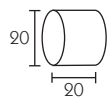

209045
Tappo
Endcap
Bouchon

Endkappe
Tapón
Zatyczka

Cod.	207074FSX / DX	
FIN		
89		15,20

Cod.	207074PSX / DX	
FIN		
89		15,20

Cod.	207074CSX / DX	
FIN		
89		15,20

Cod.	209045	
FIN	Ø mm	20
89		7,80

Components

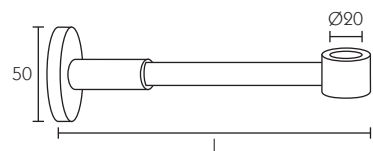

2095--
Supporto
Bracket
Support

Träger
Soporte
Wspornik

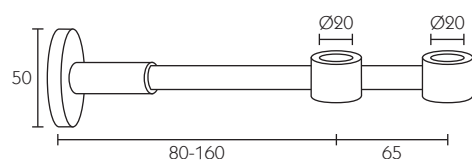

209517
Supporto doppio
Double bracket
Support double

Doppelträger
Soporte doble
Wspornik podwójny

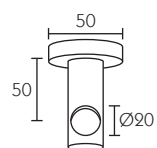

205298
Supporto a soffitto
Ceiling bracket
Support à plafond

Deckenträger
Soporte a techo
Wspornik do sufitu

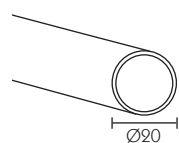

209100
Tubo
Tube
Tube
Rohr
Tubo
Rura

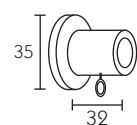

203001
Rosetta a muro
Recess bracket
Naissance murale
Wandlager
Soporte lateral
Podkładka do muru

Cod.		209518	209528
FIN	Ø mm		
89	l - mm	160	240
		28,30	29,00

Cod.		209517
FIN	Ø mm	20
89		32,00

Cod.		205298
FIN	Ø mm	20
89		25,60

Cod.		209100	203001
FIN	Ø mm	20	20
89			15,00
131 - 132 - 133 - 134		24,00	
135 - 136 - 137		24,00	



LILI & LEO

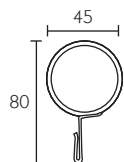

529075
Anello
Ring
Anneau

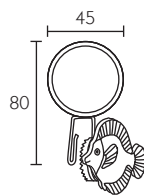

529074F
Ring
Anilla
Kólko

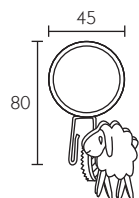

529074P
Anello
Ring
Anneau

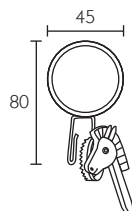

529074C
Ring
Anilla
Kólko



154

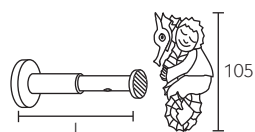

5170--FSX
Fermatenda
Holdback
Porte-embrasse

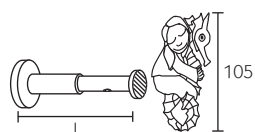

5170--FDX
Raffhalter
Alzapaño
Przytrzymanie firanki

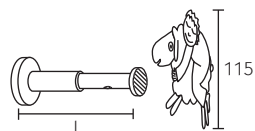

5170--PSX
Fermatenda
Holdback
Porte-embrasse

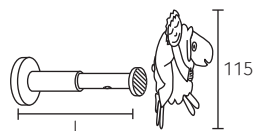

5170--PDX
Raffhalter
Alzapaño
Przytrzymanie firanki

Cod.	529075	529074F
FIN		
89	2,50	6,90

Cod.	529074P	529074C
FIN		
89	6,90	6,90

Cod.	517017FSX / DX	517018FSX / DX	517019FSX / DX
FIN	100	150	200
89	21,20	21,90	22,60

Cod.	517017PSX / DX	517018PSX / DX	517019PSX / DX
FIN	100	150	200
89	21,20	21,90	22,60

Components

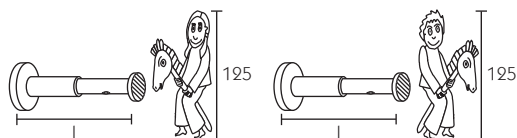

5170--CSX
Fermatenda
Holdback
Porte-embrasse

5170--CDX
Raffhalter
Alzapaño
Przytrzymanie firanki



517111PSX
Fermatenda
Holdback
Porte-embrasse

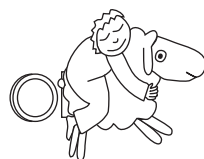

517111PDX
Raffhalter
Alzapaño
Przytrzymanie firanki

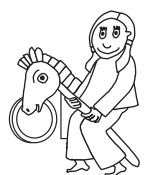

517111CSX
Fermatenda
Holdback
Porte-embrasse



517111CDX
Raffhalter
Alzapaño
Przytrzymanie firanki

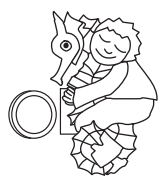

517111FSX
Fermatenda
Holdback
Porte-embrasse



517111FDX
Raffhalter
Alzapaño
Przytrzymanie firanki



CV20--B
Bordo decorato
Sticky border
Bord décoré

Brett dekoriert
Borde decorado
Manca traduzione

Cod.		517017CSX /DX	517018CSX /DX	517019CSX /DX
FIN	l - mm	100	150	200
89		21,20	21,90	22,60

Cod.	517111PSX / DX
FIN	
89	36,80

Cod.	517111CSX / DX
FIN	
89	36,80

Cod.	517111FSX / DX
FIN	
89	36,80

Cod.		CV2001B	CV2002B	CV2003B	CV2004B	CV2005B	CV2006B	CV2007B
FIN	mt 10							
Yellow		29,80						
Light Blue			29,80					
Orange				29,80				
Cream					29,80			
Pink						29,80		
Violet							29,80	
Green								29,80



ALUMINIUM COLLECTION



156

LUCILLA

FINITURE - FINISHES - FINITIONS - FERTIGUNGEN - ACABADOS - WYKOŃCZENIA

03 BNL



LUCILLA



Fin. 03
Cromo
Chrome
Chromé

Messing verchromt
Cromo
Chromowany



Fin. BNL
Laccato bianco
Lacquered white
Blanc laqué

Lackiert Weiss
Blanco lacado
Lakierowane białe

LUCILLA

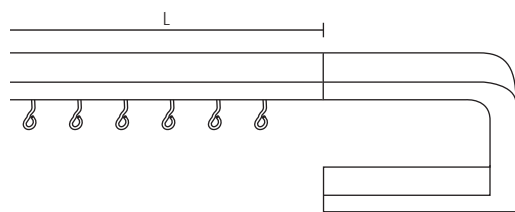

Scorritenda completo a parete
Complete curtain set
Tringle complète pose murale
Komplette Wandgarnitur
Conjunto completo a pared
Karnisz kompletny montaż do ściany

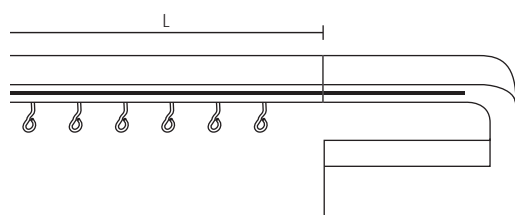

Scorritenda completo con sistema illuminante
Complete curtain set with lighting system
Tringle complète avec système d'éclairage
Komplette Garnitur mit Beleuchtung
Conjunto completo con sistema de iluminación
Karnisz kompletny z oświetleniem system

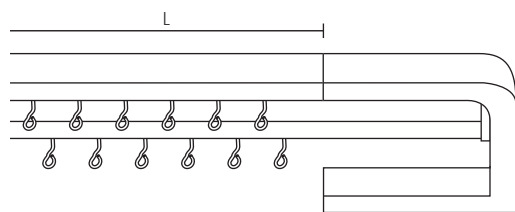

Scorritenda completo doppio a parete
Complete double curtain set
Tringle complète double pose murale
Komplette Doppelgarnitur
Conjunto completo doble a pared
Karnisz podwójny kompletny montaż do ściany

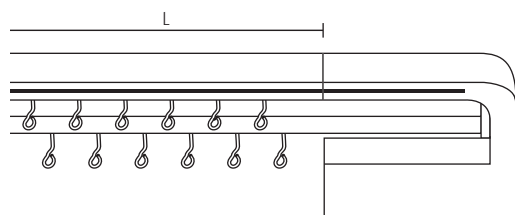

Scorritenda completo doppio con sistema illuminante
Complete double curtain set with lighting system
Tringle complète double avec système d'éclairage
Komplette doppelgarnitur mit Beleuchtung
Conjunto completo doble con sistema de iluminación
Karnisz kompletny podwójny z oświetleniem system

FIN. = Finitura - Finish - Finition - Fertigung - Acabado - Wykonczenie
Scor. = Scorrevoli - Runners - Glisseurs - Gleiter - Correderas - Ślizgacze
Sup. = Supporti - Brackets - Supports - Träger - Soportes - Wsporniki

Cod. 223A18

FIN	cm	120	140	160	180	200	220	250	300	340
03		374	392	409	426	514	532	560	601	636
BNL		332	348	364	380	457	472	499	536	567
Scor.	n.	22	24	26	28	30	32	36	40	44
Sup. cm 10	n.	2	2	2	2	3	3	3	3	3

Cod. 223L18

FIN	cm	120	140	160	180	200	220	250	300	340
03		1.763	1.821	1.879	1.937	1.995	2.123	2.212	2.354	2.470
BNL		1.721	1.777	1.834	1.890	1.946	2.063	2.150	2.288	2.401
Scor.	n.	22	24	26	28	30	32	36	40	44
Sup. cm 10	n.	2	2	2	2	3	3	3	3	3

Cod. 223C18

FIN	cm	120	140	160	180	200	220	250	300	340
03		558	593	627	662	783	822	880	962	1.027
BNL		496	528	560	591	697	734	786	860	918
Scor.	n.	36	40	44	48	52	58	66	74	80
Sup. cm 8	n.	2	2	2	2	3	3	3	3	3

Cod. 223N18

FIN	cm	120	140	160	180	200	220	250	300	340
03		1.946	2.022	2.097	2.172	2.333	2.413	2.531	2.715	2.860
BNL		1.885	1.957	2.029	2.101	2.248	2.325	2.438	2.613	2.752
Scor.	n.	36	40	44	48	52	58	66	74	80
Sup. cm 8	n.	2	2	2	2	3	3	3	3	3



LUCILLA

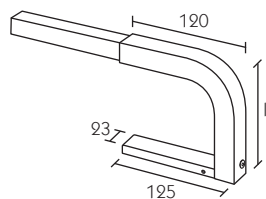

2230--

Supporto
Bracket
Support

Träger
Soporte
Wspornik

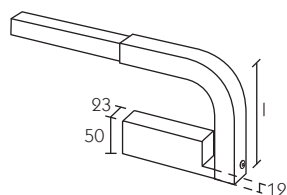

2230--

Supporto Lux
Lux bracket
Support Lux

Träger Lux
Soporte lux
Wspornik Lux

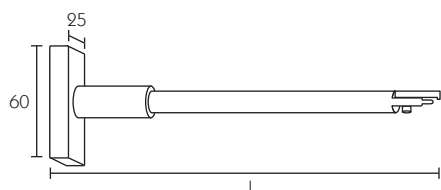

2231--

Supporto intermedio
Central bracket
Support intermédiaire

Mittelträger
Soporte intermedio
Wspornik środkowy



160

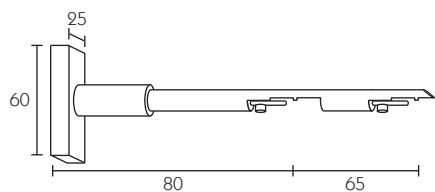

223139

Supporto intermedio doppio
Double central bracket
Support intermédiaire double
Mitteldoppelträger
Soporte intermedio doble
Wspornik środkowy podwójny

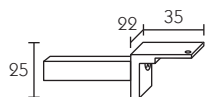

223015

Aggancio laterale
Hook for double system
Accroche pour système double
Hilfskopplung
Gancho para sistema doble
Łącznik boczny

Cod.		223018SX / DX	223028SX / DX	223038SX / DX
FIN	l - mm	100	160	220
03		122,50	132,60	142,70
BNL		106,50	115,30	124,10

Cod.		223019SX / DX	223029SX / DX	223039SX / DX
FIN	l - mm	100	160	220
03		128,60	139,20	149,90
BNL		111,90	121,10	130,30

Cod.		223118	223128	223138
FIN	l - mm	100	160	220
03		70,20	74,70	80,30
BNL		61,10	65,00	69,80

Cod.		223139
FIN	mm	80
03		85,40
BNL		74,30

Cod.		223015SX / DX
FIN	mm	100
03		20,60
BNL		17,90

Components

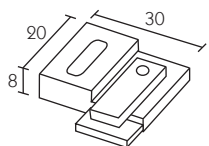

223999

Supporto soffitto
Ceiling bracket
Support à plafond

Deckenträger
Soporte a techo
Wspornik do sufitu

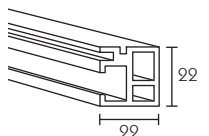

223100

Profilo
Profile
Profile
Profil
Profil
Perfil
Profil

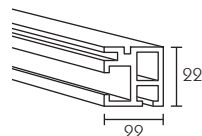

223300

Profilo Lux
Profile for Lux system
Profil pour système Lux
Profil Lux
Perfil para sistema Lux
Profil Lux

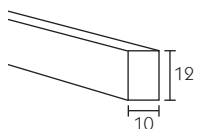

564012

Giunzione
Junction
Jonction
Verbinder
Enchufe
Łącznik

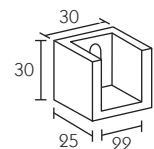

223001

Rosetta
Recess bracket
Naissance murale
Wandlager
Soporte lateral
Podkładka

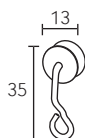

524056

Scorrevoile
Runner
Glisseur

Gleiter
Corredera
Slizgacze

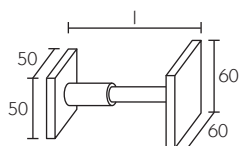

5130--

Fermatenda
Holdback
Porte-embrasse

Raffhalter
Alzapaño
Przytrzymanie firanki

Cod.	223999	
FIN		
89	26,00	

Cod.	223100	223300
FIN		
03	62,70	62,70
BNL	54,50	54,50

Cod.	564012	223001SX / DX
FIN		
03		27,00
BNL	13,50	23,20

Cod.	524056	
FIN		
98	2,45	

Cod.		513091	513092	513093
FIN	l - mm	90	160	210
03		64,20	69,10	74,00
BNL		58,30	62,80	67,30



ALUMINIUM COLLECTION



162

LUCILLA EASY

FINITURE - FINISHES - FINITIONS - FERTIGUNGEN - ACABADOS - WYKOŃCZENIA

03	325	BNL	A1	A103	A125
25	367	2BNL	A2	A203	A225
67		3BNL	A3	A303	A325
			A4	A403	A425



LUCILLA EASY



Fin. 03
Cromo
Chrome
Chromé
Messing verchromt
Cromo
Chromowany



Fin. 3BNL
Laccato bianco - Cromo
Lacquered white - Chrome
Blanc laqué - Chromé
Lackiert Weiss - Messing verchromt
Blanco lacado - Cromo
Lakierowane białe - Chromowany



Fin. A225
Tortora - Alluminio colore acciaio satinato
Dove-colored - Anodized aluminium steel color
Tourterelle - Aluminium anodisé coloris acier
Turteltaubefarbe - Aluminium eloxiert Stahl Farbe
Tórtola - Aluminio anodizado color acero
Szaro-orzechowy - Aluminium w kolorze stali matowe

LUCILLA EASY

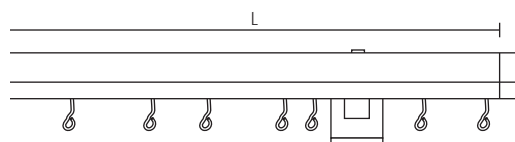

Scorritenda completo a parete
Complete curtain set
Tringle complète pose murale
Komplette Wandgarnitur
Conjunto completo a pared
Karnisz kompletny montaż do ściany

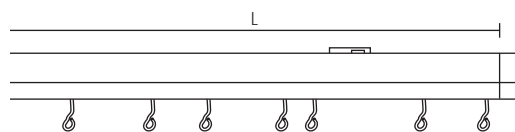

Scorritenda completo a soffitto
Complete curtain set with ceiling bracket
Tringle complète à plafond
Komplette Deckengarnitur
Conjunto completo a techo
Karnisz kompletny do sufitu

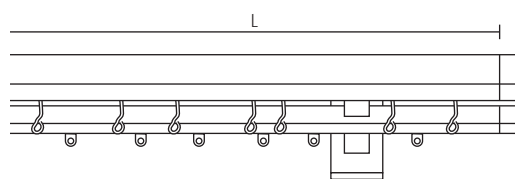

Scorritenda completo doppio a parete
Complete double curtain set
Tringle complète double pose murale
Komplette Doppelgarnitur
Conjunto completo doble a pared
Karnisz podwójny kompletny montaż do ściany

FIN. = Finitura - Finish - Finition - Fertigung - Acabado - Wykonczenie
Scor. = Scorrevoli - Runners - Glisseurs - Gleiter - Correderas - Ślizgacze
Sup. = Supporti - Brackets - Supports - Träger - Soportes - Wsporniki

Cod. 223K18

FIN	cm	120	140	160	180	200	220	250	300	340
03		261	279	296	314	331	409	438	479	514
25 - A125 - A225 - A325 - A425		218	232	247	261	276	341	365	399	428
325 - A103 - A203 - A303 - A403		244	259	273	288	302	377	402	436	465
367		235	252	270	287	305	373	401	442	477
2BNL		225	241	257	272	288	355	381	418	449
3BNL		251	267	283	299	315	391	417	454	486
Scor. Cod. 524056	n.	12	14	16	18	20	22	26	30	34
Sup. cm 9	n.	2	2	2	2	2	3	3	3	3

Cod. 223J18

FIN	cm	120	140	160	180	200	220	250	300	340
03		277	295	312	330	347	433	462	503	538
25 - A125 - A225 - A325 - A425		231	246	260	275	289	361	386	420	449
325 - A103 - A203 - A303 - A403		260	275	289	304	318	402	426	460	489
367		248	266	283	301	318	393	422	463	498
2BNL		239	254	270	286	302	375	401	438	470
3BNL		268	283	299	315	331	415	442	479	510
Scor. Cod. 524056	n.	14	16	18	20	22	26	30	34	34
Sup. cm 16	n.	2	2	2	2	2	3	3	3	3

Cod. 223V18

FIN	cm	120	140	160	180	200	220	250	300	340
03		294	311	329	346	363	458	486	528	562
25 - A125 - A225 - A325 - A425		245	259	274	288	303	381	406	440	469
325 - A103 - A203 - A303 - A403		276	291	305	320	335	426	450	484	513
367		262	279	297	314	332	413	442	483	518
2BNL		252	268	284	299	315	395	421	458	490
3BNL		284	300	315	331	347	440	466	503	535
Scor. Cod. 524056	n.	12	14	16	18	20	22	26	30	34
Sup. cm 21	n.	2	2	2	2	2	3	3	3	3

Cod. 223Z18

FIN	cm	120	140	160	180	200	220	250	300	340
03		192	209	227	244	262	305	334	375	410
25 - A125 - A225 - A325 - A425		169	183	198	212	227	267	292	326	355
325 - A103 - A203 - A303 - A403		175	189	204	218	233	273	298	332	361
367		186	203	221	238	256	299	328	369	404
2BNL		176	192	208	223	239	281	307	344	376
3BNL		182	198	214	229	245	287	313	350	382
Scor. Cod. 524056	n.	12	14	16	18	20	22	26	30	34
Sup.	n.	2	2	2	2	2	3	3	3	3

Cod. 223W18

FIN	cm	120	140	160	180	200	220	250	300	340
03		386	412	437	461	487	598	639	699	748
25 - A125 - A225 - A325 - A425		325	347	367	388	409	501	536	585	626
325 - A103 - A203 - A303 - A403		361	383	403	424	445	552	587	636	677
367		350	376	401	425	451	547	588	648	697
2BNL		340	365	387	410	435	529	568	623	669
3BNL		376	401	423	446	471	580	619	674	720
Scor. Cod. 524056	n.	12/16	14/20	16/22	18/24	20/28	22/30	26/36	30/42	34/46
Sup. cm 9	n.	2	2	2	2	2	3	3	3	3



LUCILLA EASY

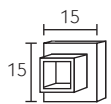

513045
Tappo
Endcap
Bouchon

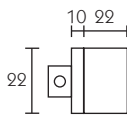

223045
Endkappe
Tapón
Zatyczka

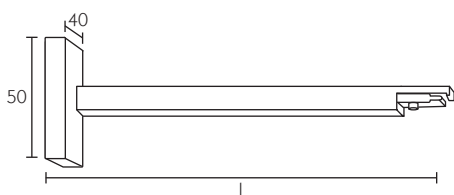

2233--
Supporto
Bracket
Support

Träger
Soporte
Wspornik

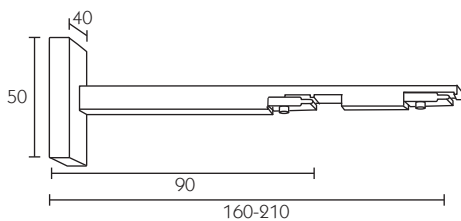

223317
Supporto doppio
Double bracket
Support double

Doppelträger
Soporte doble
Wspornik podwójny

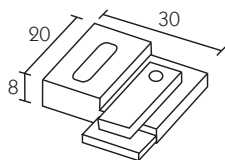

223999
Supporto a soffitto
Ceiling bracket
Support à plafond

Deckenträger
Soporte a techo
Wspornik do sufitu

Cod.	513045	223045
FIN		
03		17,60
25	14,20	14,60
67	14,20	

Cod.		223318	223328	223338
FIN	l - mm	90	160	210
03		60,70	68,80	76,90
25		50,50	57,30	64,00

Cod.		223317
FIN	l - mm	90
03		86,50
25		71,50

Cod.	223999
FIN	
89	26,00



166

Components

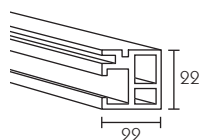

223100
 Profilo
 Profile
 Profil
 Profil
 Perfil
 Profil

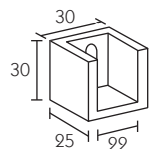

223001
 Rosetta
 Recess bracket
 Naissance murale
 Wandlager
 Soporte lateral
 Podkładka

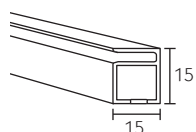

153200
 Profilo
 Profile
 Profil
 Profil
 Perfil
 Profil

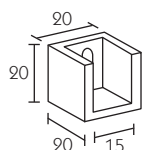

153001
 Rosetta a muro
 Recess bracket
 Naissance murale
 Wandlager
 Soporte lateral
 Podkładka do muru

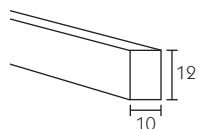

564012
 Giunzione
 Junction
 Jonction

Verbinder
 Enchufe
 Łącznik



524056
 Scorrevole
 Runner
 Glisseur



1012
 Gleiter
 Corredera
 Slizgacze

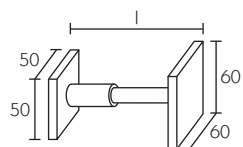

5130--
 Fermatenda
 Holdback
 Porte-embrasse

Raffhalter
 Alzapaño
 Przytrzymanie firanki

Cod.	223100	223001SX / DX
FIN		
03	62,70	27,00
25	48,30	22,00
BNL	54,50	
A1 - A2 - A3 - A4	48,30	

Cod.	153200	153001SX / DX
FIN		
03		24,50
25	20,40	20,40
67	26,80	22,50
BNL	26,80	22,50
A1 - A2 - A3 - A4	20,40	

Cod.	564012
FIN	13,50

Cod.	524056	1012
FIN		
98	2,45	0,80

Cod.		513091	513092	513093
FIN	l - mm	100	150	200
03		64,20	69,10	74,00
25		53,00	57,00	61,00
67		58,30	62,80	67,30



ALUMINIUM COLLECTION



MARCELLA

FINITURE - FINISHES - FINITIONS - FERTIGUNGEN - ACABADOS - WYKOŃCZENIA

25	BNL	A	MB
67	2BNL	B	MG
99	6BNL	W	MR



MARCELLA



Fin. 25

Alluminio colore acciaio satinato
Anodized aluminium steel color
Aluminium anodisé coloris acier

Aluminium eloxiert Stahl Farbe
Aluminio anodizado color acero
Aluminium w kolorze stali matowe



Fin. 25A

Alluminio colore acciaio satinato - Ciliegio
Anodized aluminium steel color - Cherry
Aluminium anodisé coloris acier - Merisier

Aluminium eloxiert Stahl Farbe - Kirschbaum
Aluminio anodizado color acero - Cerezo
Aluminium w kolorze stali matowe - Wiśnia



Fin. B



Fin. W



Fin. MB



Fin. MG



Fin. MR



Strass

MARCELLA

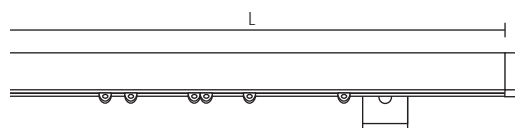

Scorritenda completo a parete
Complete curtain set
Tringle complète pose murale
Komplette Wandgarnitur
Conjunto completo a pared
Karnisz kompletny montaż do ściany

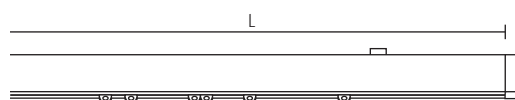

Scorritenda completo a soffitto
Complete curtain set with ceiling bracket
Tringle complète à plafond
Komplette Deckengarnitur
Conjunto completo a techo
Karnisz kompletny do sufitu

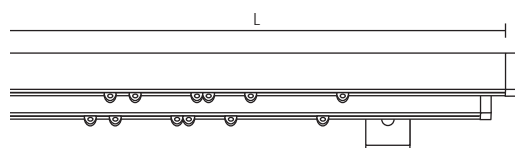

Scorritenda completo doppio a parete
Complete double curtain set
Tringle complète double pose murale
Komplette Doppelgarnitur
Conjunto completo doble a pared
Karnisz podwójny kompletny montaż do ściany

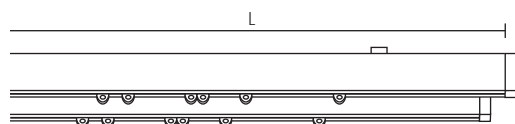

Scorritenda completo doppio a soffitto
Complete double curtain set with ceiling bracket
Tringle complète double à plafond
Komplette Decken-Doppelgarnitur
Conjunto completo doble a techo
Karnisz kompletny podwójny do sufitu

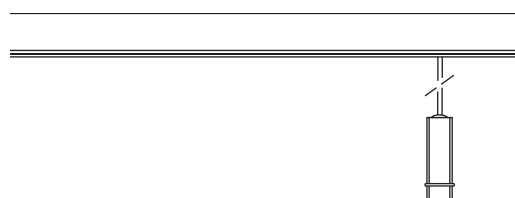

FIN. = Finitura - Finish - Finition - Fertigung - Acabado - Wykonczenie
Scor. = Scorrevoli - Runners - Glisseurs - Gleiter - Correderas - Ślizgacze
Sup. = Supporti - Brackets - Supports - Träger - Soportes - Wsporniki

Cod. 313A45

FIN	cm	120	140	160	180	200	220	250	300	340
25		152	160	168	176	184	228	240	260	275
67		176	185	194	203	211	264	277	299	316
99		195	205	215	225	236	293	308	334	354
25 + wood		148	155	162	170	177	220	231	249	263
67 + wood		167	175	182	189	196	248	259	277	291
2BNL		157	166	174	183	192	236	250	271	289
6BNL		176	185	194	203	211	264	277	299	316
Scor. Cod. 1000	n.	16	20	22	24	28	30	36	42	46
Sup. cm 16	n.	2	2	2	2	2	3	3	3	3

Cod. 313T45

FIN	cm	120	140	160	180	200	220	250	300	340
25		103	111	119	127	135	154	166	186	202
67		111	120	129	137	146	166	180	201	219
99		124	134	144	155	165	187	202	228	248
25 + wood		99	106	113	121	128	146	157	175	190
67 + wood		102	110	117	124	131	150	161	179	193
2BNL		108	117	125	134	143	163	176	198	215
6BNL		111	120	129	137	146	166	180	201	219
Scor. Cod. 1000	n.	16	20	22	24	28	30	36	42	46
Sup.	n.	2	2	2	2	2	3	3	3	3

Cod. 313B45

FIN	cm	120	140	160	180	200	220	250	300	340
25		272	288	304	319	335	407	431	470	502
67		296	314	331	349	366	443	470	513	548
99		346	367	388	408	429	521	552	603	644
25 + wood		263	278	292	306	321	391	413	449	477
67 + wood		278	293	307	322	336	410	432	468	497
2BNL		281	299	316	333	351	424	450	494	528
6BNL		296	314	331	349	366	443	470	513	548
Scor. Cod. 1000	n.	16/16	20/20	22/22	24/24	28/28	30/30	36/36	42/42	46/46
Sup. cm 16	n.	2	2	2	2	2	3	3	3	3

Cod. 313W45

FIN	cm	120	140	160	180	200	220	250	300	340
25		202	218	234	250	266	302	326	366	397
67		227	244	262	279	296	339	365	409	443
99		256	277	297	317	338	385	416	468	508
25 + wood		193	208	222	237	251	286	308	344	373
67 + wood		209	223	238	252	266	306	328	364	392
2BNL		211	229	246	264	281	319	346	389	424
6BNL		227	244	262	279	296	339	365	409	443
Scor. Cod. 1000	n.	16/16	20/20	22/22	24/24	28/28	30/30	36/36	42/42	46/46
Sup.	n.	2	2	2	2	2	3	3	3	3

Maggiorazione movimento a corda - Surcharge for corded systems - Supplément pour tirage
Zuschlag für Schnurbedienung - Suplemento por cuerda - Dodatkowo koszt mechanizmu

cm	120	140	160	180	200	220	250	300	340
	72	72	72	72	77	77	77	77	77



MARCELLA

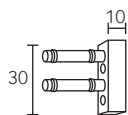

313045
Terminale
Finial
Embout

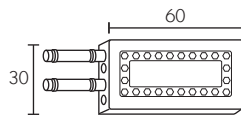

303003
Endstück
Terminal
Końcówka

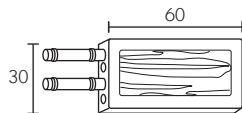

303004
Terminale
Finial
Embout

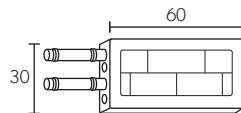

303074
Endstück
Terminal
Końcówka

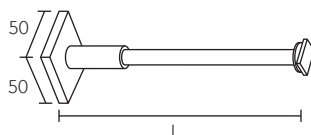

3133--
Supporto
Bracket
Support

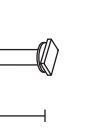

Träger
Soporte
Wspornik

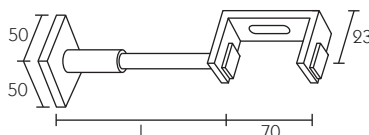

3134--
Supporto doppio
Double bracket
Support double

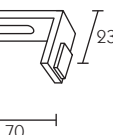

Doppelträger
Soporte doble
Wspornik podwójny

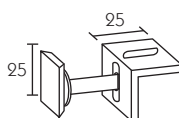

313598
Supporto a soffitto
Ceiling bracket
Support à plafond
Deckenträger
Soporte a techo
Wspornik do sufitu

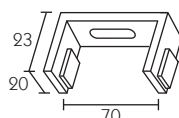

313587
Supporto doppio a soffitto
Double ceiling bracket
Support à plafond double
Decken-Doppelträger
Soporte doble a techo
Wspornik podwójny do sufitu

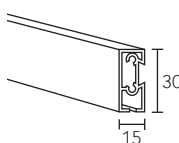

313300
Profilo
Profile
Profil
Profil
Perfil
Profil

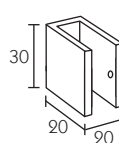

313003
Rosetta a muro
Recess bracket
Naissance murale
Wandlager
Soporte lateral
Podkładka do muru

Cod.	313045SX / DX	303003SX / DX
FIN		
25	16,40	33,00
67	18,10	36,00
99	19,80	39,00

Cod.	303004SX / DX	303074SX / DX
FIN		
25 + wood	31,00	
67 + wood	31,00	
99 + wood	37,00	
25 + pearl		60,00
67 + pearl		60,00
99 + pearl		66,00

Cod.	313318	313328
FIN	l - mm	210
25	35,90	38,40
67	44,00	48,00
99	46,70	50,00

Cod.	313437	313447
FIN	l - mm	210
25	55,50	58,60
67	59,70	62,80
99	72,10	76,20

Cod.	313598	313587
FIN		
25	11,40	20,60
67	11,40	24,80
99	11,40	26,80

Cod.	313300	313003SX / DX
FIN		
25	38,60	21,80
67	42,50	23,90
99	50,20	28,50
A - B - W	35,00	
BNL	42,50	23,90



Components

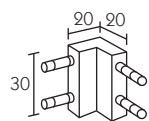

313312
Angolare
Angle
Angle
Ecke
Ângulo
Narozny

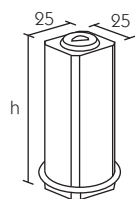

5630--
Fiocco piatto
Flat weight
Contrepoids plat
Schnurbeswerer
Contrapeso plano
Obciążnik płaski



1000
Scorrevole
Runner
Glisseur



1001
Gleiter
Corredera
Ślizgacze

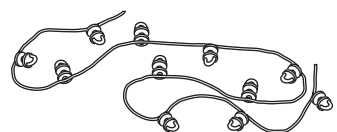

1000P-
Scorrevoli
Runners
Glisseurs

Gleiter
Correderas
Ślizgacze

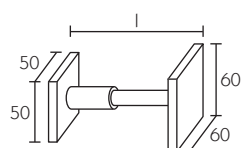

5130-
Fermatenda
Holdback
Porte-embrasse

Raffhalter
Alzapaño
Przytrzymanie firanki

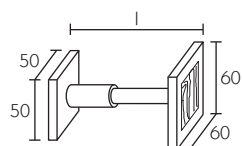

5130-
Fermatenda
Holdback
Porte-embrasse

Raffhalter
Alzapaño
Przytrzymanie firanki

Cod.		313312SX / DX	563007	563008
FIN	h - mm		80	100
25		33,00	23,50	26,00
67		36,00	26,00	31,00
99		39,00	30,00	34,00

Cod.		1000	1001
FIN		0,08	0,61

Cod.		1000P6*	1000P8**
FIN			
Euro/mt		6,74	6,74

* Scorrevoli passo 60 mm - Runners each 60 mm - Glisseurs tous les 60 mm - Gleiter je 60 mm - Correderas cada 60 mm - Ślizgi co 60 mm
** Scorrevoli passo 80 mm - Runners each 80 mm - Glisseurs tous les 80 mm - Gleiter je 80 mm - Correderas cada 80 mm - Ślizgi co 80 mm

Cod.		513091	513092	513093
FIN	l - mm	100	150	200
25		53,00	57,00	61,00
67		58,30	62,80	67,30
99		79,50	84,70	89,90
BNL		58,30	62,80	67,30

Cod.		513081	513082	513083
FIN	l - mm	100	150	200
25 + wood		67,00	71,00	75,00
25 + strass		78,00	82,00	86,00
25 + pearl		88,00	92,00	96,00
67 + wood		72,30	76,80	81,30
67 + strass		83,30	87,80	92,30
67 + pearl		93,30	97,80	102,30
99 + wood		93,50	98,70	103,90
99 + strass		104,50	109,70	114,90
99 + pearl		114,50	119,70	124,90



ALUMINIUM COLLECTION



NADIA

FINITURE - FINISHES - FINITIONS - FERTIGUNGEN - ACABADOS - WYKOŃCZENIA

25	258	A125	A167
67	678	A225	A267
85		A325	A367
		A425	A467





Fin. A167

Avorio - Alluminio lucido
Ivory - Bright aluminium
Ivoire - Aluminium poli

Elfenbein - Aluminium poliert
Marfil - Aluminio pulido
Kość słoniowa - Aluminium polerowane



Fin. 25

Alluminio colore acciaio satinato
Anodized aluminium steel color
Aluminium anodisé coloris acier

Aluminium eloxiert Stahl Farbe
Aluminio anodizado color acero
Aluminium w kolorze stali matowe

NADIA

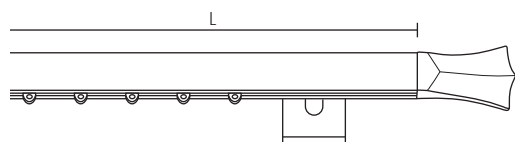

Scorritenda completo a parete
Complete curtain set
Tringle complète pose murale
Komplette Wandgarnitur
Conjunto completo a pared
Karnisz kompletny montaż do ściany

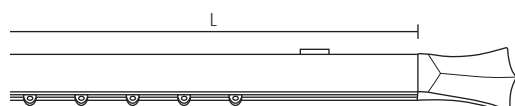

Scorritenda completo a soffitto
Complete curtain set with ceiling bracket
Tringle complète à plafond
Komplette Deckengarnitur
Conjunto completo a techo
Karnisz kompletny do sufitu

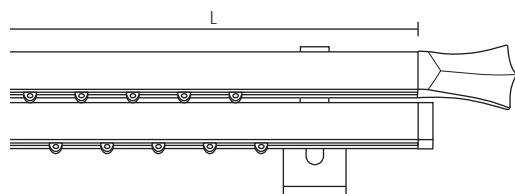

Scorritenda completo doppio a parete
Complete double curtain set
Tringle complète double pose murale
Komplette Doppelgarnitur
Conjunto completo doble a pared
Karnisz podwójny kompletny montaż do ściany

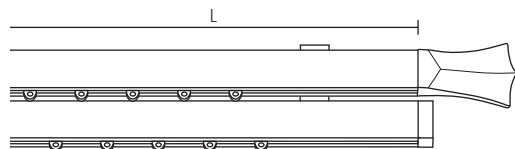

Scorritenda completo doppio a soffitto
Complete double curtain set with ceiling bracket
Tringle complète double à plafond
Komplette Decken-Doppelgarnitur
Conjunto completo doble a techo
Karnisz kompletny podwójny do sufitu

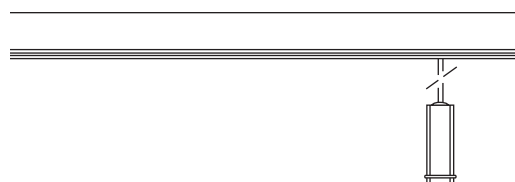

FIN. = Finitura - Finish - Finition - Fertigung - Acabado - Wykonczenie
Scor. = Scorrevoli - Runners - Glisseurs - Gleiter - Correderas - Ślizgacze
Sup. = Supporti - Brackets - Supports - Träger - Soportes - Wsporniki

Cod. 313A25		∅ 30 mm								
FIN	cm	120	140	160	180	200	220	250	300	340
25		194	202	210	218	226	270	282	302	318
67		230	239	248	256	265	318	331	353	370
258		190	197	205	212	219	262	273	291	305
678		221	229	236	243	250	301	312	330	345
A125 - A225 - A325		190	197	205	212	219	262	273	291	305
A167 - A267 - A367		221	229	236	243	250	301	312	330	345
Scor. Cod. 1000	n.	16	20	22	24	28	30	36	42	46
Sup. cm 16	n.	2	2	2	2	2	3	3	3	3

Cod. 313T25		∅ 30 mm								
FIN	cm	120	140	160	180	200	220	250	300	340
25		145	153	161	169	177	197	209	228	244
67		165	174	183	191	200	220	233	255	272
258		141	148	156	163	170	189	200	218	232
678		156	163	171	178	185	204	215	233	247
A125 - A225 - A325		141	148	156	163	170	189	200	218	232
A167 - A267 - A367		156	163	171	178	185	204	215	233	247
Scor. Cod. 1000	n.	16	20	22	24	28	30	36	42	46
Sup.	n.	2	2	2	2	2	3	3	3	3

Cod. 313B25		∅ 30 mm								
FIN	cm	120	140	160	180	200	220	250	300	340
25		314	330	346	362	378	449	473	513	544
67		350	368	385	402	420	497	524	567	602
258		305	320	334	349	363	433	455	491	520
678		332	347	361	375	390	464	486	522	551
A125 - A225 - A325		305	320	334	349	363	433	455	491	520
A167 - A267 - A367		332	347	361	375	390	464	486	522	551
Scor. Cod. 1000	n.	16/16	20/20	22/22	24/24	28/28	30/30	36/36	42/42	46/46
Sup. cm 16	n.	2	2	2	2	2	3	3	3	3

Cod. 313W25		∅ 30 mm								
FIN	cm	120	140	160	180	200	220	250	300	340
25		244	260	276	292	308	344	368	408	439
67		280	298	315	333	350	392	419	462	497
258		236	250	265	279	293	328	350	386	415
678		262	277	291	306	320	359	381	417	446
A125 - A225 - A325		236	250	265	279	293	328	350	386	415
A167 - A267 - A367		262	277	291	306	320	359	381	417	446
Scor. Cod. 1000	n.	16/16	20/20	22/22	24/24	28/28	30/30	36/36	42/42	46/46
Sup.	n.	2	2	2	2	2	3	3	3	3

Maggiorazione movimento a corda - Surcharge for corded systems - Supplément pour tirage
Zuschlag für Schnurbedienung - Suplemento por cuerda - Dodatkowo koszt mechanizmu

cm	120	140	160	180	200	220	250	300	340
	72	72	72	72	77	77	77	77	77



NADIA

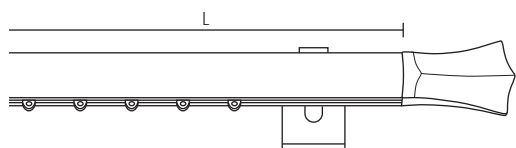

Scorritenda completo a parete
Complete curtain set
Tringle complète pose murale
Komplette Wandgarnitur
Conjunto completo a pared
Karnisz kompletny montaż do ściany

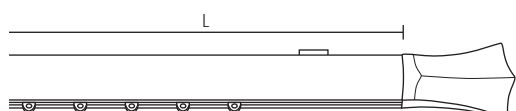

Scorritenda completo a soffitto
Complete curtain set with ceiling bracket
Tringle complète à plafond
Komplette Deckengarnitur
Conjunto completo a techo
Karnisz kompletny do sufitu

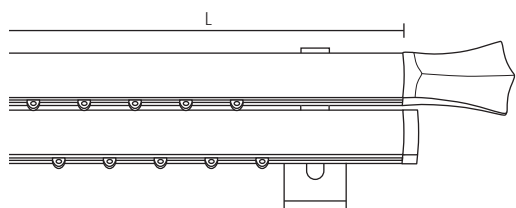

Scorritenda completo doppio a parete
Complete double curtain set
Tringle complète double pose murale
Komplette Doppelgarnitur
Conjunto completo doble a pared
Karnisz podwójny kompletny montaż do ściany

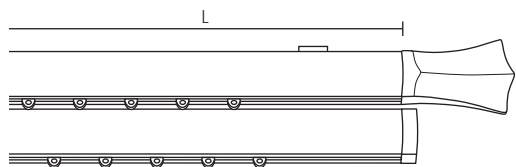

Scorritenda completo doppio a soffitto
Complete double curtain set with ceiling bracket
Tringle complète double à plafond
Komplette Decken-Doppelgarnitur
Conjunto completo doble a techo
Karnisz kompletny podwójny do sufitu

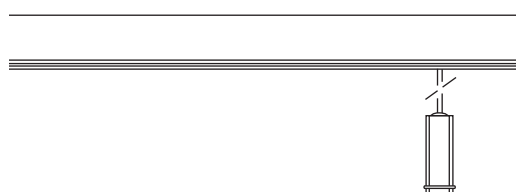

FIN. = Finitura - Finish - Finition - Fertigung - Acabado - Wykonczenie
Scor. = Scorrevoli - Runners - Glisseurs - Gleiter - Correderas - Ślizgacze
Sup. = Supporti - Brackets - Supports - Träger - Soportes - Wsporniki

Cod. 423A25		Ø 40 mm								
FIN	cm	120	140	160	180	200	220	250	300	340
25		213	222	231	239	248	257	306	327	344
67		252	262	271	281	290	300	358	382	401
258		209	217	224	232	240	248	296	315	331
678		242	250	258	266	273	281	337	357	372
A125 - A225 - A325		209	217	224	232	240	248	296	315	331
A167 - A267 - A367		242	250	258	266	273	281	337	357	372
Scor. Cod. 1000	n.	16	20	22	24	28	30	36	42	46
Sup. cm 16	n.	2	2	2	2	2	2	3	3	3

Cod. 423T25		Ø 40 mm								
FIN	cm	120	140	160	180	200	220	250	300	340
25		164	173	182	190	199	208	232	254	271
67		187	197	206	216	225	235	261	284	303
258		160	168	175	183	191	199	222	242	257
678		177	185	193	200	208	216	239	259	274
A125 - A225 - A325		160	168	175	183	191	199	222	242	257
A167 - A267 - A367		177	185	193	200	208	216	239	259	274
Scor. Cod. 1000	n.	16	20	22	24	28	30	36	42	46
Sup.	n.	2	2	2	2	2	2	3	3	3

Cod. 423B25		Ø 40 mm								
FIN	cm	120	140	160	180	200	220	250	300	340
25		343	361	378	395	412	429	511	554	588
67		387	407	426	444	464	483	571	619	656
258		334	349	365	380	396	412	491	530	561
678		367	383	398	414	430	445	529	568	599
A125 - A225 - A325		334	349	365	380	396	412	491	530	561
A167 - A267 - A367		367	383	398	414	430	445	529	568	599
Scor. Cod. 1000	n.	16/16	20/20	22/22	24/24	28/28	30/30	36/36	42/42	46/46
Sup. cm 16	n.	2	2	2	2	2	2	3	3	3

Cod. 423W25		Ø 40 mm								
FIN	cm	120	140	160	180	200	220	250	300	340
25		273	291	308	325	342	360	406	449	484
67		318	337	356	375	394	413	466	514	552
258		264	280	295	311	326	342	386	425	456
678		297	313	329	344	360	375	424	463	494
A125 - A225 - A325		264	280	295	311	326	342	386	425	456
A167 - A267 - A367		297	313	329	344	360	375	424	463	494
Scor. Cod. 1000	n.	16/16	20/20	22/22	24/24	28/28	30/30	36/36	42/42	46/46
Sup.	n.	2	2	2	2	2	2	3	3	3

Maggiorazione movimento a corda - Surcharge for corded systems - Supplément pour tirage
Zuschlag für Schnurbedienung - Suplemento por cuerda - Dodatkowo koszt mechanizmu

cm	120	140	160	180	200	220	250	300	340
	72	72	72	72	77	77	77	77	77



Components

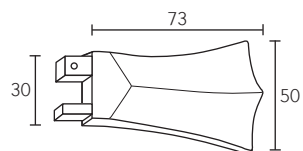

313025

Terminale
Fial
Embout

Endstück
Terminal
Końcówka

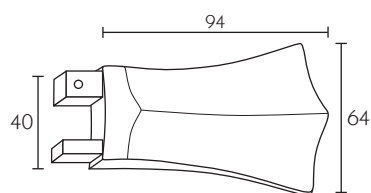

423025

Terminale
Fial
Embout

Endstück
Terminal
Końcówka

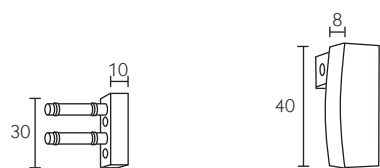

313045

Tappo
Endcap
Bouchon

423101

Endkappe
Tapón
Zatyczka

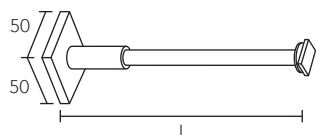

3133--

Supporto
Bracket
Support

Träger
Soporte
Wspornik

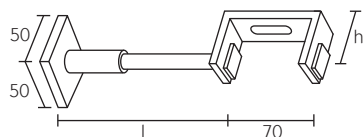

3134--

Supporto doppio
Double bracket
Support double

Doppelträger
Soporte doble
Wspornik podwójny

Cod.	313025SX / DX	
FIN		
25		37,50
67		45,00
85		34,50
A1 - A2 - A3		34,50

Cod.	423025SX / DX	
FIN		
25		45,00
67		53,60
85		41,40
A1 - A2 - A3		41,40

Cod.		313045SX / DX	423101SX / DX
FIN	∅ mm	30	40
25		16,40	19,40
67		18,10	23,30
85		16,40	19,40

Cod.		313318	313328
FIN	l - mm	160	210
25		35,90	38,40
67		44,00	48,00

Cod.		313437	313447	313417	313427
FIN	h - mm	23	23	35	35
FIN	l - mm	160	210	160	210
25		55,50	58,60	55,50	58,60
67		59,70	62,80	59,70	62,80



NADIA

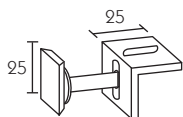

313598

Supporto a soffitto
Ceiling bracket
Support à plafond

Deckenträger
Soporte a techo
Wspornik do sufitu

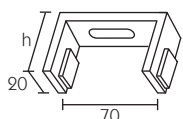

3135--

Supporto doppio a soffitto
Double ceiling bracket
Support à plafond double
Decken-Doppelträger
Soporte doble a techo
Wspornik podwójny do sufitu

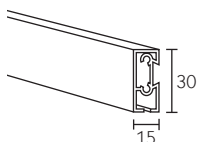

313300

Profilo
Profile
Profil
Profil
Perfil
Profil

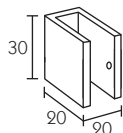

313003

Rosetta a muro
Recess bracket
Naissance murale
Wandlager
Soporte lateral
Podkładka do muru

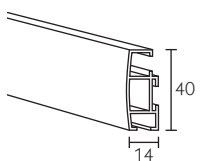

423100

Profilo
Profile
Profil
Profil
Perfil
Profil

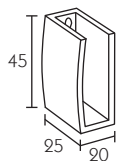

423001

Rosetta a muro
Recess bracket
Naissance murale
Wandlager
Soporte lateral
Podkładka do muru

Cod.	313598
FIN	
25	11,40
67	11,40

Cod.	h - mm	313587	313597
FIN		23	35
25		20,60	20,60
67		24,80	24,80

Cod.	313300	313003SX / DX
FIN		
25	38,60	21,80
67	42,50	23,90
85	35,00	21,80
A1 - A2 - A3	35,00	21,80

Cod.	423100	423001SX / DX
FIN		
25	42,00	28,00
67	46,50	31,00
85	38,00	28,00
A1 - A2 - A3	38,00	28,00



180

Components



1000
Scorrevole
Runner
Glisseur



1001
Gleiter
Corredera
Ślizgacze

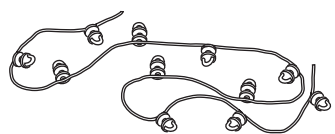

1000--
Scorrevoli
Runners
Glisseurs

Gleiter
Correderas
Ślizgacze

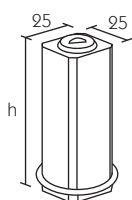

5630--
Fiocco piatto
Flat weight
Contrepoids plat

Schnurbeschwerer
Contrapeso plano
Obciążnik płaski

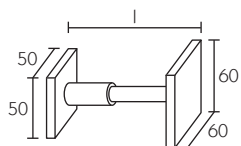

5130--
Fermatenda
Holdback
Porte-embrasse

Raffhalter
Alzapaño
Przytrzymanie firanki

Cod.	1000	1001
FIN	0,08	0,61

Cod.	1000P6*	1000P8**
FIN		
Euro/mt	6,74	6,74

* Scorrevoli passo 60 mm - Runners each 60 mm - Glisseurs tous les 60 mm - Gleiter je 60 mm - Correderas cada 60 mm - Ślizgi co 60 mm
** Scorrevoli passo 80 mm - Runners each 80 mm - Glisseurs tous les 80 mm - Gleiter je 80 mm - Correderas cada 80 mm - Ślizgi co 80 mm

Cod.		563007	563008
FIN	h - mm	80	100
25		23,50	26,00
67		26,00	31,00

Cod.		513091	513092	513093
FIN	l - mm	100	150	200
25		53,00	57,00	61,00
67		58,30	62,80	67,30
BNL		58,30	62,80	67,30



ALUMINIUM COLLECTION



182

NINA

FINITURE - FINISHES - FINITIONS - FERTIGUNGEN - ACABADOS - WYKOŃCZENIA

25	125	A1	A125	A167
67	258	A2	A225	A267
85	267	A3	A325	A367
	678			





Fin. 125

Alluminio colore acciaio satinato - Alluminio lucido
Anodized aluminium steel color - Bright aluminium
Aluminium anodisé coloris acier - Aluminium poli

Aluminium eloxiert Stahl Farbe - Aluminium poliert
Aluminio anodizado color acero - Aluminio pulido
Aluminium w kolorze stali matowe - Aluminium polerowane



Fin. A225

Tortora - Alluminio colore acciaio satinato
Dove-colored - Anodized aluminium steel color
Tourterelle - Aluminium anodisé coloris acier

Turteltaubefarbe - Aluminium eloxiert Stahl Farbe
Tórtola - Aluminio anodizado color acero
Szaro-orzechowy - Aluminium w kolorze stali matowe

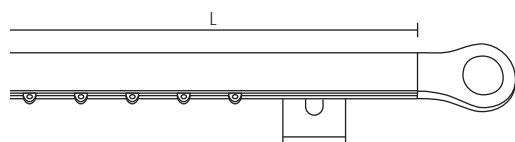

Scorritenda completo a parete
Complete curtain set
Tringle complète pose murale
Komplette Wandgarnitur
Conjunto completo a pared
Karnisz kompletny montaż do ściany

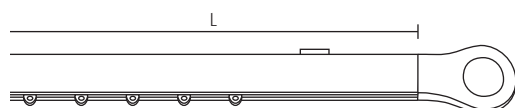

Scorritenda completo a soffitto
Complete curtain set with ceiling bracket
Tringle complète à plafond
Komplette Deckengarnitur
Conjunto completo a techo
Karnisz kompletny do sufitu

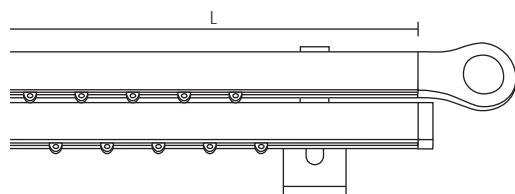

Scorritenda completo doppio a parete
Complete double curtain set
Tringle complète double pose murale
Komplette Doppelgarnitur
Conjunto completo doble a pared
Karnisz podwójny kompletny montaż do ściany

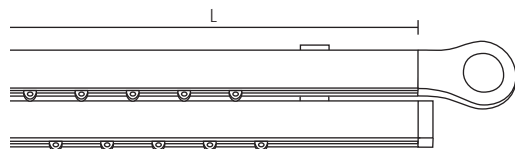

Scorritenda completo doppio a soffitto
Complete double curtain set with ceiling bracket
Tringle complète double à plafond
Komplette Decken-Doppelgarnitur
Conjunto completo doble a techo
Karnisz kompletny podwójny do sufitu

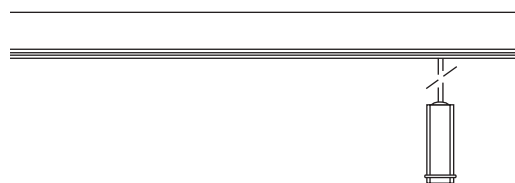

FIN. = Finitura - Finish - Finition - Fertigung - Acabado - Wykonczenie
Scor. = Scorrevoli - Runners - Glisseurs - Gleiter - Correderas - Ślizgacze
Sup. = Supporti - Brackets - Supports - Träger - Soportes - Wsporniki

Cod. 313A26		∅ 30 mm								
FIN	cm	120	140	160	180	200	220	250	300	340
125		208	216	224	231	239	291	303	323	339
258		187	194	202	209	216	259	270	288	302
267		211	220	229	237	246	291	304	326	343
678		203	211	218	225	232	283	294	312	327
A125 - A225 - A325		187	194	202	209	216	259	270	288	302
A167 - A267 - A367		203	211	218	225	232	283	294	312	327
Scor. Cod. 1000	n.	16	20	22	24	28	30	36	42	46
Sup. cm 16	n.	2	2	2	2	2	3	3	3	3

Cod. 313T26		∅ 30 mm								
FIN	cm	120	140	160	180	200	220	250	300	340
125		142	150	158	166	174	194	206	225	241
258		138	145	153	160	167	186	197	215	229
267		162	171	180	188	197	217	230	252	269
678		138	145	153	160	167	186	197	215	229
A125 - A225 - A325		138	145	153	160	167	186	197	215	229
A167 - A267 - A367		138	145	153	160	167	186	197	215	229
Scor. Cod. 1000	n.	16	20	22	24	28	30	36	42	46
Sup.	n.	2	2	2	2	2	3	3	3	3

Cod. 313B26		∅ 30 mm								
FIN	cm	120	140	160	180	200	220	250	300	340
125		323	339	355	370	386	462	486	526	557
258		302	317	331	346	360	430	452	488	517
267		335	353	370	388	405	478	505	548	583
678		314	329	343	357	372	446	468	504	533
A125 - A225 - A325		302	317	331	346	360	430	452	488	517
A167 - A267 - A367		314	329	343	357	372	446	468	504	533
Scor. Cod. 1000	n.	16/16	20/20	22/22	24/24	28/28	30/30	36/36	42/42	46/46
Sup. cm 16	n.	2	2	2	2	2	3	3	3	3

Cod. 313W26		∅ 30 mm								
FIN	cm	120	140	160	180	200	220	250	300	340
125		253	269	285	301	317	357	381	421	452
258		233	247	262	276	290	325	347	383	412
267		266	283	301	318	335	373	400	443	478
678		244	259	273	288	302	341	363	399	428
A125 - A225 - A325		233	247	262	276	290	325	347	383	412
A167 - A267 - A367		244	259	273	288	302	341	363	399	428
Scor. Cod. 1000	n.	16/16	20/20	22/22	24/24	28/28	30/30	36/36	42/42	46/46
Sup.	n.	2	2	2	2	2	3	3	3	3

Maggiorazione movimento a corda - Surcharge for corded systems - Supplément pour tirage
Zuschlag für Schnurbedienung - Suplemento por cuerda - Dodatkowo koszt mechanizmu

cm	120	140	160	180	200	220	250	300	340
	72	72	72	72	77	77	77	77	77

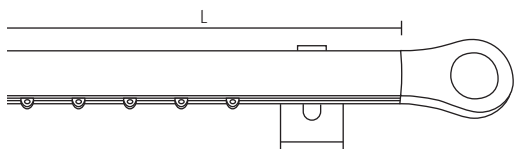

Scorritenda completo a parete
Complete curtain set
Tringle complète pose murale
Komplette Wandgarnitur
Conjunto completo a pared
Karnisz kompletny montaż do ściany

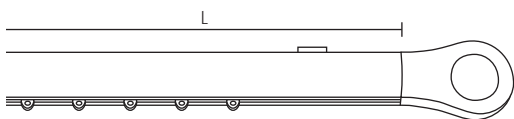

Scorritenda completo a soffitto
Complete curtain set with ceiling bracket
Tringle complète à plafond
Komplette Deckengarnitur
Conjunto completo a techo
Karnisz kompletny do sufitu

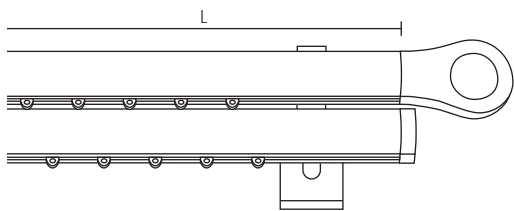

Scorritenda completo doppio a parete
Complete double curtain set
Tringle complète double pose murale
Komplette Doppelgarnitur
Conjunto completo doble a pared
Karnisz podwójny kompletny montaż do ściany

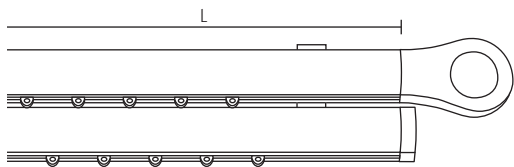

Scorritenda completo doppio a soffitto
Complete double curtain set with ceiling bracket
Tringle complète double à plafond
Komplette Decken-Doppelgarnitur
Conjunto completo doble a techo
Karnisz kompletny podwójny do sufitu

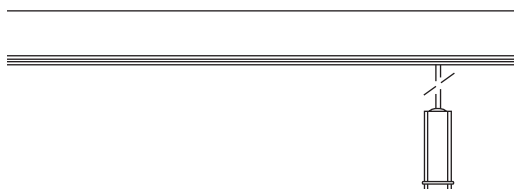

FIN. = Finitura - Finish - Finition - Fertigung - Acabado - Wykonczenie
Scor. = Scorrevoli - Runners - Glisseurs - Gleiter - Correderas - Ślizgacze
Sup. = Supporti - Brackets - Supports - Träger - Soportes - Wsporniki

Cod. 423A26		Ø 40 mm								
FIN	cm	120	140	160	180	200	220	250	300	340
125		222	231	240	248	257	266	323	344	361
258		201	209	217	225	233	241	288	308	323
267		229	239	248	257	267	277	327	351	369
678		218	226	233	241	249	257	313	332	348
A125 - A225 - A325		201	209	217	225	233	241	288	308	323
A167 - A267 - A367		218	226	233	241	249	257	313	332	348
Scor. Cod. 1000	n.	16	20	22	24	28	30	36	42	46
Sup. cm 16	n.	2	2	2	2	2	2	3	3	3

Cod. 423T26		Ø 40 mm								
FIN	cm	120	140	160	180	200	220	250	300	340
125		157	166	175	183	192	200	225	246	263
258		152	160	168	176	184	192	215	234	250
267		180	190	199	208	218	228	253	277	296
678		152	160	168	176	184	192	215	234	250
A125 - A225 - A325		152	160	168	176	184	192	215	234	250
A167 - A267 - A367		152	160	168	176	184	192	215	234	250
Scor. Cod. 1000	n.	16	20	22	24	28	30	36	42	46
Sup.	n.	2	2	2	2	2	2	3	3	3

Cod. 423B26		Ø 40 mm								
FIN	cm	120	140	160	180	200	220	250	300	340
125		352	370	387	404	421	438	524	567	601
258		326	342	358	373	389	405	484	523	554
267		364	383	402	421	440	459	544	591	629
678		343	358	374	389	405	421	504	543	574
A125 - A225 - A325		326	342	358	373	389	405	484	523	554
A167 - A267 - A367		343	358	374	389	405	421	504	543	574
Scor. Cod. 1000	n.	16/16	20/20	22/22	24/24	28/28	30/30	36/36	42/42	46/46
Sup. cm 16	n.	2	2	2	2	2	2	3	3	3

Cod. 423W26		Ø 40 mm								
FIN	cm	120	140	160	180	200	220	250	300	340
125		282	300	317	334	351	369	420	463	497
258		257	272	288	303	319	335	379	418	449
267		294	313	332	351	370	389	439	486	524
678		273	289	304	320	335	351	400	439	470
A125 - A225 - A325		257	272	288	303	319	335	379	418	449
A167 - A267 - A367		273	289	304	320	335	351	400	439	470
Scor. Cod. 1000	n.	16/16	20/20	22/22	24/24	28/28	30/30	36/36	42/42	46/46
Sup.	n.	2	2	2	2	2	2	3	3	3

Maggiorazione movimento a corda - Surcharge for corded systems - Supplément pour tirage
Zuschlag für Schnurbedienung - Suplemento por cuerda - Dodatkowo koszt mechanizmu

cm	120	140	160	180	200	220	250	300	340
	72	72	72	72	77	77	77	77	77

Components

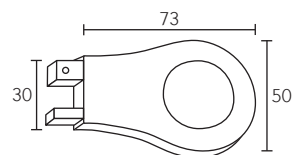

313026
 Terminale Endstück
 Fial Terminal
 Embout Końcówka

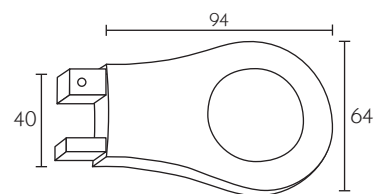

423026
 Terminale Endstück
 Fial Terminal
 Embout Końcówka

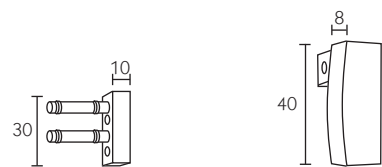

313045 423101
 Tappo Endkappe
 Endcap Tapón
 Bouchon Zatyczka

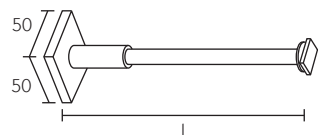

3133--
 Supporto Träger
 Bracket Soporite
 Support Wspornik

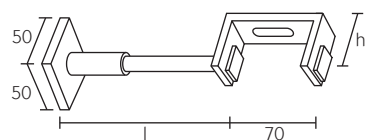

3134--
 Supporto doppio Doppelträger
 Double bracket Soporite doble
 Support double Wspornik podwójny

Cod.	313026SX / DX	
FIN		
125		36,00
258		36,00
267		43,50
678		36,00
A125 - A225 - A325		36,00
A167 - A267 - A367		36,00

Cod.	423026SX / DX	
FIN		
125		41,40
258		41,40
267		50,00
678		41,40
A125 - A225 - A325		41,40
A167 - A267 - A367		41,40

Cod.		313045SX / DX	423101SX / DX
FIN	∅ mm	30	40
25		16,40	19,40
67		18,10	23,30
85		16,40	19,40

Cod.		313318	313328
FIN	l - mm	160	210
25		35,90	38,40
67		44,00	48,00

Cod.		313437	313447	313417	313427
FIN	h - mm	23	23	35	35
FIN	l - mm	160	210	160	210
25		55,50	58,60	55,50	58,60
67		59,70	62,80	59,70	62,80



NINA

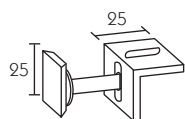

313598

Supporto a soffitto
Ceiling bracket
Support à plafond

Deckenträger
Soporte a techo
Wspornik do sufitu

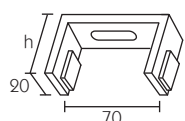

3135--

Supporto doppio a soffitto
Double ceiling bracket
Support à plafond double
Decken-Doppelträger
Soporte doble a techo
Wspornik podwójny do sufitu

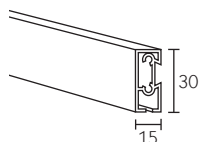

313300

Profilo
Profile
Profil
Profil
Perfil
Profil

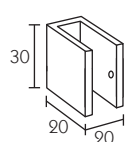

313003

Rosetta a muro
Recess bracket
Naissance murale
Wandlager
Soporte lateral
Podkładka do muru

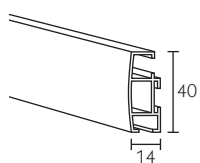

423100

Profilo
Profile
Profil
Profil
Perfil
Profil

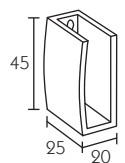

423001

Rosetta a muro
Recess bracket
Naissance murale
Wandlager
Soporte lateral
Podkładka do muru

Cod.	313598
FIN	
25	11,40
67	11,40

Cod.	h - mm	313587	313597
FIN		23	35
25		20,60	20,60
67		24,80	24,80
312		20,60	20,60

Cod.	313300	313003SX / DX
FIN		
25	38,60	21,80
67	42,50	23,90
85	35,00	21,80
A1 - A2 - A3	35,00	21,80

Cod.	423100	423001SX / DX
FIN		
25	42,00	28,00
67	46,50	31,00
85	38,00	28,00
A1 - A2 - A3	38,00	28,00



188

Components



1000
Scorrevole
Runner
Glisseur



1001
Gleiter
Corredera
Ślizgacze

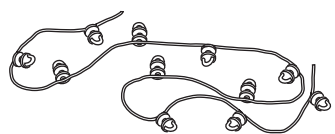

1000--
Scorrevoli
Runners
Glisseurs

Gleiter
Correderas
Ślizgacze

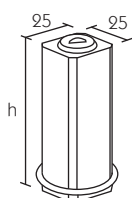

5630--
Fiocco piatto
Flat weight
Contrepoids plat

Schnurbeschwerer
Contrapeso plano
Obciążnik płaski

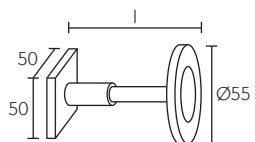

5130--
Fermatenda
Holdback
Porte-embrasse

Raffhalter
Alzapaño
Przytrzymanie firanki

Cod.	1000	1001
FIN	0,08	0,61

Cod.	1000P6*	1000P8**
FIN		
Euro/mt	6,74	6,74

* Scorrevoli passo 60 mm - Runners each 60 mm - Glisseurs tous les 60 mm - Gleiter je 60 mm - Correderas cada 60 mm - Ślizgi co 60 mm
 ** Scorrevoli passo 80 mm - Runners each 80 mm - Glisseurs tous les 80 mm - Gleiter je 80 mm - Correderas cada 80 mm - Ślizgi co 80 mm

Cod.		563007	563008
FIN	h - mm	80	100
25		23,50	26,00
67		26,00	31,00

Cod.		513023	513034	513066
FIN	l - mm	100	150	200
25 - 125 - 258		65,00	69,00	73,00
67 - 267 - 678		71,50	76,00	80,50
A125 - A225 - A325		65,00	69,00	73,00
A167 - A267 - A367		65,00	69,00	73,00



ALUMINIUM COLLECTION

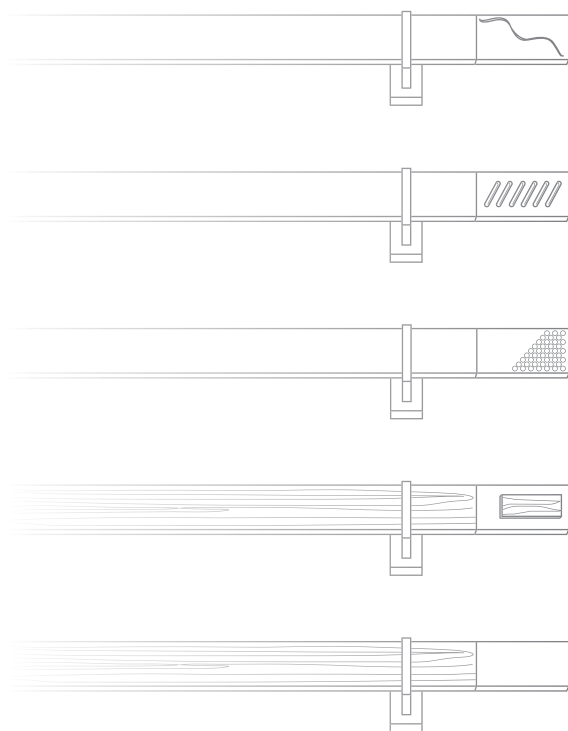

PRISCILLA

FINITURE - FINISHES - FINITIONS - FERTIGUNGEN - ACABADOS - WYKOŃCZENIA

67	181	A
81		B
		DC
		T
		W



PRISCILLA WOOD

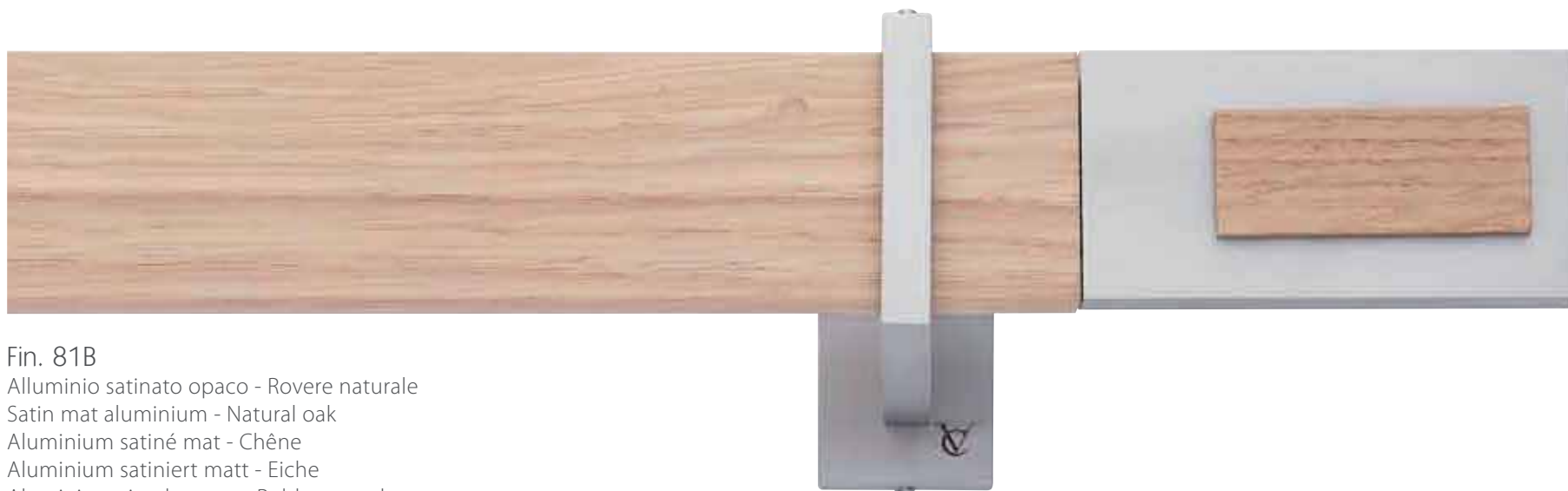

Fin. 81B

Alluminio satinato opaco - Rovere naturale
Satin mat aluminium - Natural oak
Aluminium satiné mat - Chêne
Aluminium satiniert matt - Eiche
Aluminio satinado mate - Roble natural
Aluminium satynowy matowy - Dąb naturalny

PRISCILLA CLASSIC



Fin. 67W

Alluminio lucido - Wengé
Bright aluminium - Wengé
Aluminium poli - Wengé
Aluminium poliert - Wengé
Aluminio pulido - Wengé
Aluminium polerowane - Wengé



Fin. A



Fin. DC

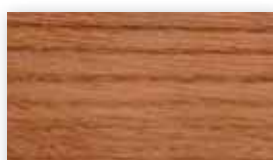

Fin. T

PRISCILLA WAVE

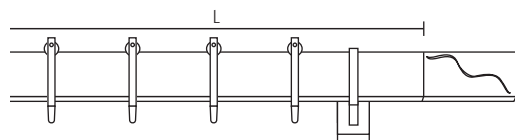

Scorritenda completo a parete
Complete curtain set
Tringle complète pose murale
Komplette Wandgarnitur
Conjunto completo a pared
Karnisz kompletny montaż do ściany

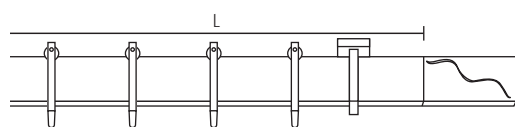

Scorritenda completo a soffitto
Complete curtain set with ceiling bracket
Tringle complète à plafond
Komplette Deckengarnitur
Conjunto completo a techo
Karnisz kompletny do sufitu

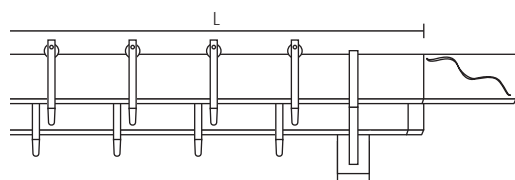

Scorritenda completo doppio a parete
Complete double curtain set
Tringle complète double pose murale
Komplette Doppelgarnitur
Conjunto completo doble a pared
Karnisz podwójny kompletny montaż do ściany

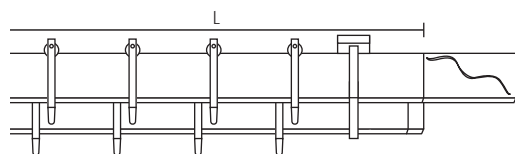

Scorritenda completo doppio a soffitto
Complete double curtain set with ceiling bracket
Tringle complète double à plafond
Komplette Decken-Doppelgarnitur
Conjunto completo doble a techo
Karnisz kompletny podwójny do sufitu

FIN. = Finitura - Finish - Finition - Fertigung - Acabado - Wykonczenie
An. = Anelli - Rings - Anneaux - Ringe - Anillas - Kółka
Sup. = Supporti - Brackets - Supports - Träger - Soportes - Wsporniki

Cod. 413A04

FIN	cm	120	140	160	180	200	220	250	300	340
67		303	323	343	363	383	403	500	545	585
81		284	302	320	339	357	375	465	506	542
181		305	323	342	360	378	396	491	531	568
An.	n.	12	14	16	18	20	22	26	30	34
Sup. cm 9	n.	2	2	2	2	2	2	3	3	3

Cod. 413T04

FIN	cm	120	140	160	180	200	220	250	300	340
67		303	323	343	363	383	403	500	545	585
81		284	302	320	339	357	375	465	506	542
181		305	323	342	360	378	396	491	531	568
An.	n.	12	14	16	18	20	22	26	30	34
Sup. cm 2	n.	2	2	2	2	2	2	3	3	3

Cod. 413B04

FIN	cm	120	140	160	180	200	220	250	300	340
67		485	525	565	605	645	685	830	920	1000
81		452	489	525	562	599	635	771	852	925
181		476	513	549	586	622	659	799	880	953
An.	n.	12/12	14/14	16/16	18/18	20/20	22/22	26/26	30/30	34/34
Sup. cm 9	n.	2	2	2	2	2	2	3	3	3

Cod. 413W04

FIN	cm	120	140	160	180	200	220	250	300	340
67		466	506	546	587	627	667	803	892	972
81		428	464	501	537	574	610	734	815	888
181		458	494	531	567	604	641	771	852	925
An.	n.	12/12	14/14	16/16	18/18	20/20	22/22	26/26	30/30	34/34
Sup. cm 2	n.	2	2	2	2	2	2	3	3	3



PRISCILLA WOOD

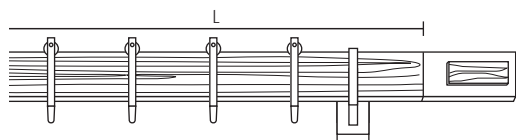

Scorritenda completo a parete
Complete curtain set
Tringle complète pose murale
Komplette Wandgarnitur
Conjunto completo a pared
Karnisz kompletny montaż do ściany

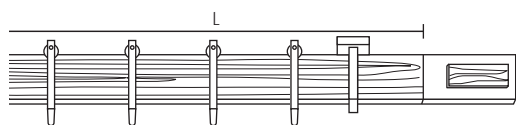

Scorritenda completo a soffitto
Complete curtain set with ceiling bracket
Tringle complète à plafond
Komplette Deckengarnitur
Conjunto completo a techo
Karnisz kompletny do sufitu

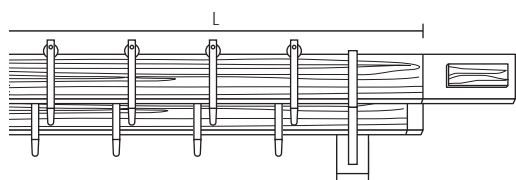

Scorritenda completo doppio a parete
Complete double curtain set
Tringle complète double pose murale
Komplette Doppelgarnitur
Conjunto completo doble a pared
Karnisz podwójny kompletny montaż do ściany

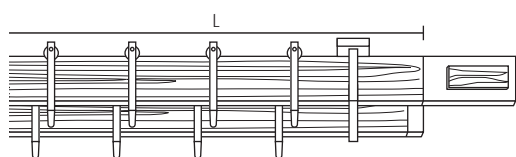

Scorritenda completo doppio a soffitto
Complete double curtain set with ceiling bracket
Tringle complète double à plafond
Komplette Decken-Doppelgarnitur
Conjunto completo doble a techo
Karnisz kompletny podwójny do sufitu

FIN. = Finitura - Finish - Finition - Fertigung - Acabado - Wykonczenie
An. = Anelli - Rings - Anneaux - Ringe - Anillas - Kółka
Sup. = Supporti - Brackets - Supports - Träger - Soportes - Wsporniki

Cod. 413A02

FIN	cm	120	140	160	180	200	220	250	300	340
67 A - B - DC - T - W		358	386	415	443	471	499	608	673	729
81 A - B - DC - T - W		344	372	401	429	457	485	590	655	711
An.	n.	12	14	16	18	20	22	26	30	34
Sup. cm 9	n.	2	2	2	2	2	2	3	3	3

Cod. 413T02

FIN	cm	120	140	160	180	200	220	250	300	340
67 A - B - DC - T - W		358	386	415	443	471	499	608	673	729
81 A - B - DC - T - W		344	372	401	429	457	485	590	655	711
An.	n.	12	14	16	18	20	22	26	30	34
Sup. cm 2	n.	2	2	2	2	2	2	3	3	3

Cod. 413B02

FIN	cm	120	140	160	180	200	220	250	300	340
67 A - B - DC - T - W		588	645	701	757	814	870	1.039	1.169	1.282
81 A - B - DC - T - W		572	628	685	741	797	853	1.019	1.149	1.262
An.	n.	12/12	14/14	16/16	18/18	20/20	22/22	26/26	30/30	34/34
Sup. cm 9	n.	2	2	2	2	2	2	3	3	3

Cod. 413W02

FIN	cm	120	140	160	180	200	220	250	300	340
67 A - B - DC - T - W		570	626	683	739	795	851	1.012	1.142	1.254
81 A - B - DC - T - W		547	604	660	716	772	829	982	1.112	1.225
An.	n.	12/12	14/14	16/16	18/18	20/20	22/22	26/26	30/30	34/34
Sup. cm 2	n.	2	2	2	2	2	2	3	3	3



Components

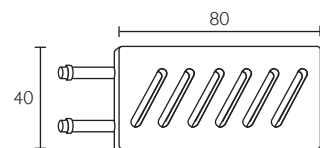

413003

Terminale **Line** Endstück **Line**
 Finial **Line** Terminal **Line**
 Embout **Line** Końcówka **Line**

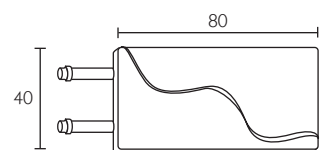

413004

Terminale **Wave** Endstück **Wave**
 Finial **Wave** Terminal **Wave**
 Embout **Wave** Końcówka **Wave**

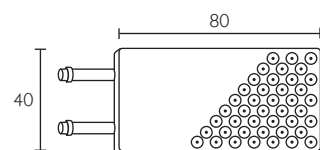

413005

Terminale **Rain** Endstück **Rain**
 Finial **Rain** Terminal **Rain**
 Embout **Rain** Końcówka **Rain**

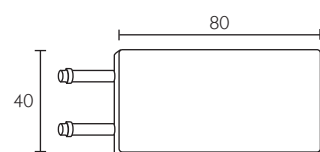

413012

Terminale **Classic** Endstück **Classic**
 Finial **Classic** Terminal **Classic**
 Embout **Classic** Końcówka **Classic**

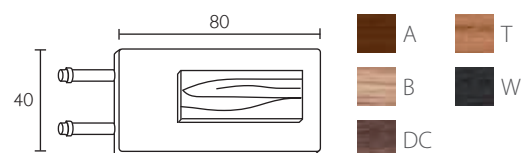

413002

Terminale **Wood** Endstück **Wood**
 Finial **Wood** Terminal **Wood**
 Embout **Wood** Końcówka **Wood**

Cod.	413003SX / DX
FIN	
67	27,70
81	26,30

Cod.	413004SX / DX
FIN	
67	29,70
81	29,70
181	36,00

Cod.	413005SX / DX
FIN	
67	27,70
81	26,30

Cod.	413012SX / DX
FIN	
67	27,00
81	25,30

Cod.	413002SX / DX
FIN	
67 A - B - DC - T - W	33,00
81 A - B - DC - T - W	30,40



PRISCILLA

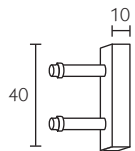

413045

Tappo
Endcap
Bouchon

Endkappe
Tapón
Zatyczka

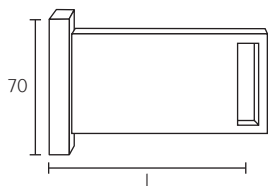

4132--

Supporto
Bracket
Support

Träger
Soporte
Wspornik

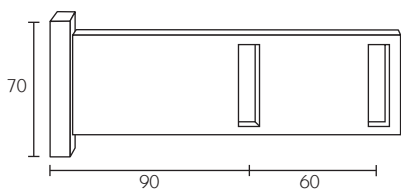

413217

Supporto doppio
Double bracket
Support double

Doppelträger
Soporte doble
Wspornik podwójny



196

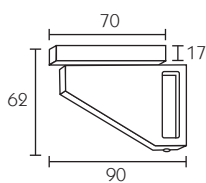

413518

Supporto a soffitto
Ceiling bracket
Support à plafond

Deckenträger
Soporte a techo
Wspornik do sufitu

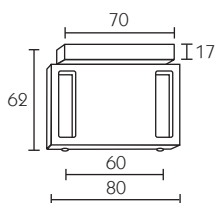

413517

Supporto doppio a soffitto
Double ceiling bracket
Support à plafond double
Decken-Doppelträger
Soporte doble a techo
Wspornik podwójny do sufitu

Cod.	413045SX / DX
FIN	
67	18,00
81	16,00

Cod.		413218	413228	413238
FIN	l - mm	90	160	220
67		61,70	67,00	74,40
81		57,30	62,90	70,80

Cod.	413217
FIN	
67	74,40
81	70,80

Cod.	413518
FIN	
67	61,70
81	57,30

Cod.	413517
FIN	
67	65,20
81	58,40

Components

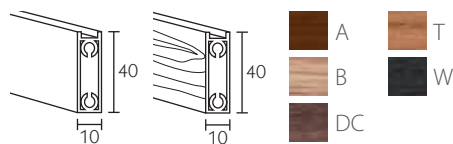

413100

Profilo
Profile
Profil

Profil
Perfil
Profil



413001

Rosetta a muro
Recess bracket
Naissance murale
Wandlager
Soporte lateral
Podkładka do muru

563002

Angolare
Angle
Angle
Ecke
Ángulo
Narozny

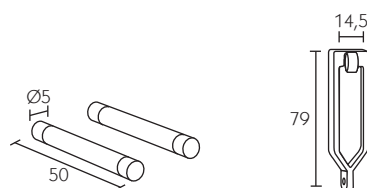

568029

Giunzione
Junction
Jonction
Verbinder
Enchufe
Łącznik

523055

Anello graffetta
Clip ring
Anneau agrafe
Klammer Ring
Anilla clip
Kółko klamra

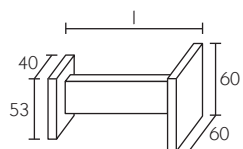

5130--

Fermatenda
Holdback
Porte-embrasse

Raffhalter
Alzapaño
Przytrzymanie firanki

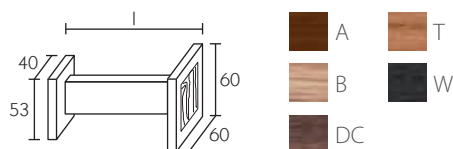

5130--

Fermatenda
Holdback
Porte-embrasse

Raffhalter
Alzapaño
Przytrzymanie firanki

Cod.	413100	
FIN		
67		47,20
81		38,40
A - B - DC - T - W		87,70

Cod.	413001SX / DX	563002
FIN		
67	37,60	42,70
81	30,00	40,10

Cod.	568029	523055
FIN		
67	15,20	5,30
81	15,20	5,30

Cod.		513031	513032	513033
FIN	l - mm	100	150	200
67		84,30	89,90	95,50
81		69,00	73,50	78,00

Cod.		513094	513095	513096
FIN	l - mm	100	150	200
67 A - B - DC - T - W		98,30	103,90	109,50
81 A - B - DC - T - W		83,00	87,50	92,00



ALUMINIUM COLLECTION



RITA

FINITURE - FINISHES - FINITIONS - FERTIGUNGEN - ACABADOS - WYKOŃCZENIA

25

67



RITA



Fin. 67
Alluminio lucido
Bright aluminium
Aluminium poli

Aluminium poliert
aluminio pulido
Aluminium polerowane



Fin. 25
Alluminio colore acciaio satinato
Anodized aluminium steel color
Aluminium anodisé coloris acier

Aluminium eloxiert Stahl Farbe
Aluminio anodizado color acero
Aluminium w kolorze stali matowe

RITA

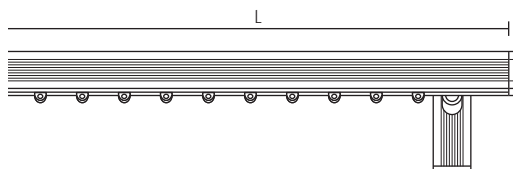

Scorritenda completo a parete
Complete curtain set
Tringle complète pose murale
Komplette Wandgarnitur
Conjunto completo a pared
Karnisz kompletny montaż do ściany

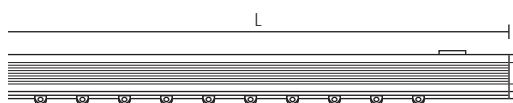

Scorritenda completo a soffitto
Complete curtain set with ceiling bracket
Tringle complète à plafond
Komplette Deckengarnitur
Conjunto completo a techo
Karnisz kompletny do sufitu

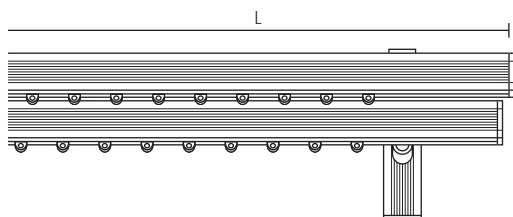

Scorritenda completo doppio a parete
Complete double curtain set
Tringle complète double pose murale
Komplette Doppelgarnitur
Conjunto completo doble a pared
Karnisz podwójny kompletny montaż do ściany

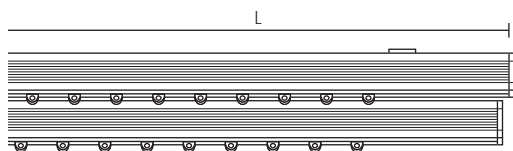

Scorritenda completo doppio a soffitto
Complete double curtain set with ceiling bracket
Tringle complète double à plafond
Komplette Decken-Doppelgarnitur
Conjunto completo doble a techo
Karnisz kompletny podwójny do sufitu

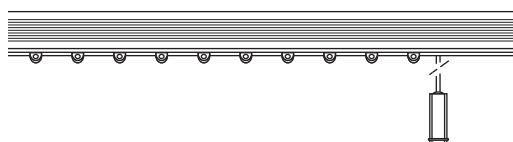

FIN. = Finitura - Finish - Finition - Fertigung - Acabado - Wykonczenie
Scor. = Scorrevoli - Runners - Glisseurs - Gleiter - Correderas - Ślizgacze
Sup. = Supporti - Brackets - Supports - Träger - Soportes - Wsporniki

Cod. 333A41

FIN	cm	120	140	160	180	200	220	250	300	340
25		171	180	189	197	206	260	273	295	313
67		195	205	215	225	235	294	309	334	354
Scor.	n.	16	20	22	24	28	30	36	42	46
Sup. cm 16	n.	2	2	2	2	2	3	3	3	3

Cod. 333T41

FIN	cm	120	140	160	180	200	220	250	300	340
25		104	113	122	130	139	159	173	195	212
67		119	130	140	150	160	181	196	221	241
Scor.	n.	16	20	22	24	28	30	36	42	46
Sup.	n.	2	2	2	2	2	3	3	3	3

Cod. 333C41

FIN	cm	120	140	160	180	200	220	250	300	340
25		273	291	309	326	344	417	444	487	522
67		315	336	356	375	396	477	507	557	597
Scor.	n.	16/16	20/20	22/22	24/24	28/28	30/30	36/36	42/42	46/46
Sup. cm 16	n.	2	2	2	2	2	3	3	3	3

Cod. 333H41

FIN	cm	120	140	160	180	200	220	250	300	340
25		204	221	239	256	274	312	339	383	418
67		243	263	283	303	323	368	398	448	488
Scor.	n.	16/16	20/20	22/22	24/24	28/28	30/30	36/36	42/42	46/46
Sup.	n.	2	2	2	2	2	3	3	3	3

Maggiorazione movimento a corda - Surcharge for corded systems - Supplément pour tirage
Zuschlag für Schnurbedienung - Suplemento por cuerda - Dodatkowo koszt mechanizmu

cm	120	140	160	180	200	220	250	300	340
	72	72	72	72	77	77	77	77	77



RITA

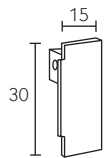

333041

Terminale
Finial
Embout

Endstück
Terminal
Końcówka

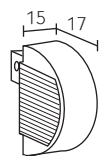

333042

Terminale
Finial
Embout

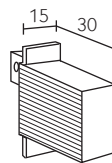

333043

Endstück
Terminal
Końcówka

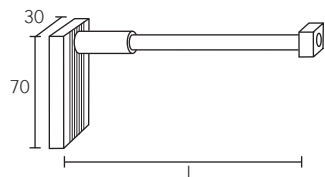

3331--

Supporto
Bracket
Support

Träger
Soporte
Wspornik

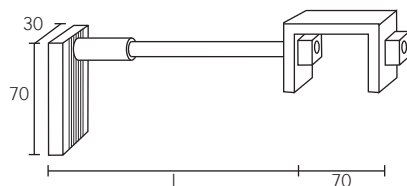

3334--

Supporto doppio
Double bracket
Support double

Doppelträger
Soporte doble
Wspornik podwójny

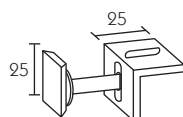

313598

Supporto a soffitto
Ceiling bracket
Support à plafond

Deckenträger
Soporte a techo
Wspornik do sufitu

Cod.	333041SX / DX	
FIN		
25		14,20
67		18,30

Cod.	333042SX / DX	333043SX / DX
FIN		
25	27,50	30,60
67	33,20	36,70

Cod.		333119	333129
FIN	l - mm	160	210
25		44,90	48,00
67		49,00	53,10

Cod.		333417	333427
FIN	l - mm	160	210
25		55,50	58,60
67		61,00	64,40

Cod.	313598	
FIN		
25		11,40
67		11,40



Components

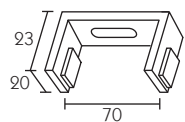

313587

Supporto doppio a soffitto
Double ceiling bracket
Support à plafond double
Decken-Doppelträger
Soporte doble a techo
Wspornik podwójny do sufitu

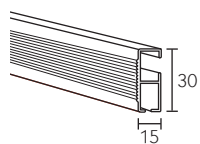

333100

Profilo
Profile
Profil
Profil
Perfil
Profil

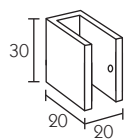

313003

Rosetta a muro
Recess bracket
Naissance murale
Wandlager
Soporte lateral
Podkładka do muru



1000

Scorrevole
Runner
Glisseur



1001

Gleiter
Corredera
Ślizgacze

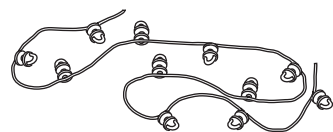

1000--

Scorrevoli
Runners
Glisseurs

Gleiter
Correderas
Ślizgacze

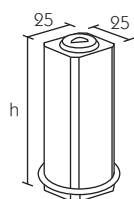

5630--

Fiocco piatto
Flat weight
Contrepoids plat

Schnurbeswerer
Contrapeso plano
Obciążnik płaski

Cod.	313587	
FIN		
25		20,60
67		24,80

Cod.	333100	313003SX / DX
FIN		
25	42,90	21,80
67	49,00	23,90

Cod.	1000	1001
FIN		
	0,08	0,61

Cod.	1000P6*	1000P8**
FIN		
Euro/mt	6,74	6,74

* Scorrevoli passo 60 mm - Runners each 60 mm - Glisseurs tous les 60 mm - Gleiter je 60 mm - Correderas cada 60 mm - Ślizgi co 60 mm
** Scorrevoli passo 80 mm - Runners each 80 mm - Glisseurs tous les 80 mm - Gleiter je 80 mm - Correderas cada 80 mm - Ślizgi co 80 mm

Cod.		563007	563008
FIN	h - mm	80	100
25		23,50	26,00
67		26,00	31,00



ALUMINIUM COLLECTION

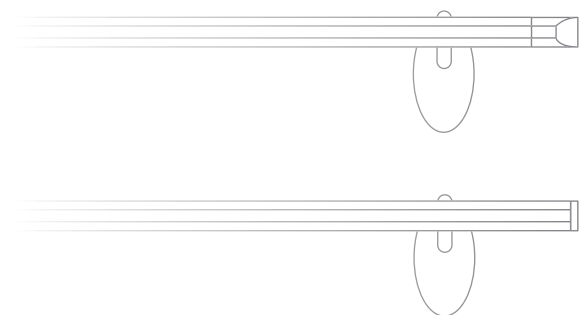

SABINA

FINITURE - FINISHES - FINITIONS - FERTIGUNGEN - ACABADOS - WYKOŃCZENIA

25	925	BNL	A1	A125	A167
39	967	2BNL	A2	A225	A267
67		6BNL	A3	A325	A367
			A4	A425	A467



SABINA

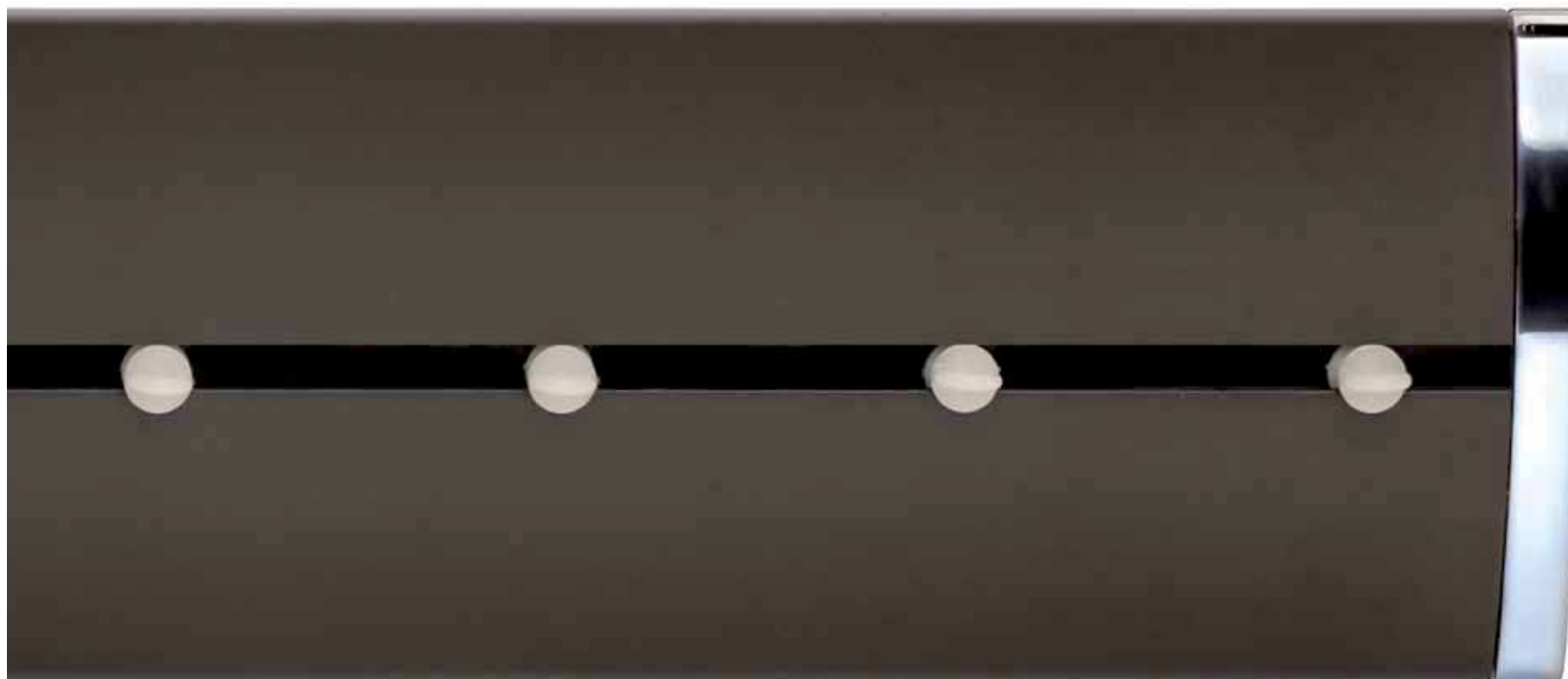

Fin. 967

Bronzo opaco - Alluminio lucido

Mat bronze - Bright aluminium

Bronze mat - Aluminium poli

Bronze matt - Aluminium poliert

Bronze mate - Aluminio pulido

Brąz matowy - Aluminium polerowane



Fin. 67

Alluminio lucido

Bright aluminium

Aluminium poli

Aluminium poliert

Aluminio pulido

Aluminium polerowane

SABINA

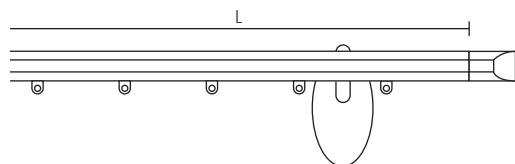

Scorritenda completo a parete
Complete curtain set
Tringle complète pose murale
Komplette Wandgarnitur
Conjunto completo a pared
Karnisz kompletny montaż do ściany

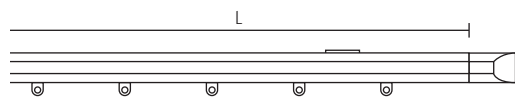

Scorritenda completo a soffitto
Complete curtain set with ceiling bracket
Tringle complète à plafond
Komplette Deckengarnitur
Conjunto completo a techo
Karnisz kompletny do sufitu

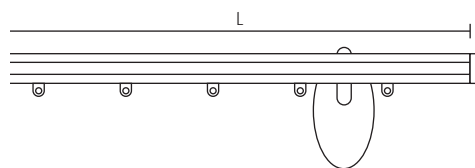

Scorritenda completo a parete
Complete curtain set
Tringle complète pose murale
Komplette Wandgarnitur
Conjunto completo a pared
Karnisz kompletny montaż do ściany

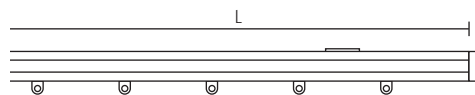

Scorritenda completo a soffitto
Complete curtain set with ceiling bracket
Tringle complète à plafond
Komplette Deckengarnitur
Conjunto completo a techo
Karnisz kompletny do sufitu

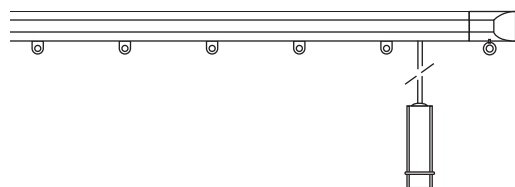

FIN. = Finitura - Finish - Finition - Fertigung - Acabado - Wykonczenie
Term. = Terminale - Finial - Embout - Endstück - Terminal - Końcówka
Scor. = Scorrevoli - Runners - Glisseurs - Gleiter - Correderas - Ślizgacze
Sup. = Supporti - Brackets - Supports - Träger - Soportes - Wsporniki

Cod. 993K03

FIN	cm	160	180	200	220	250	300	340
25 - 925		330	343	356	440	460	494	520
67 - 6BNL		359	373	388	480	501	538	567
967		349	363	376	466	486	520	547
A125 - A225 - A325 - A425		330	343	356	440	460	494	520
A167 - A267 - A367 - A467		349	363	376	466	486	520	547
2BNL		339	354	368	453	475	512	541
Scor. Cod. 1000P6 - 1000P8	n.							
Sup. Cod. 993109	n.	2	2	2	3	3	3	3

Cod. 993T03

FIN	cm	160	180	200	220	250	300	340
25 - 925		196	210	227	240	260	294	320
67 - 6BNL		212	226	245	259	281	317	346
967		202	216	233	246	266	299	326
A125 - A225 - A325 - A425		196	210	227	240	260	294	320
A167 - A267 - A367 - A467		202	216	233	246	266	299	326
2BNL		206	221	239	253	275	312	341
Scor. Cod. 1000P6 - 1000P8	n.							
Sup. Cod. 993298	n.	2	2	3	3	3	3	3

Cod. 993A45

FIN	cm	160	180	200	220	250	300	340
25 - 925		295	308	321	405	425	459	485
67 - 6BNL		323	337	352	444	465	502	531
967		313	327	340	430	450	484	511
A125 - A225 - A325 - A425		295	308	321	405	425	459	485
A167 - A267 - A367 - A467		313	327	340	430	450	484	511
2BNL		304	319	333	418	440	477	506
Scor. Cod. 1000P6 - 1000P8	n.							
Sup. Cod. 993109	n.	2	2	2	3	3	3	3

Cod. 993T45

FIN	cm	160	180	200	220	250	300	340
25 - 925		161	175	192	205	225	259	285
67 - 6BNL		176	190	209	223	245	281	310
967		166	180	197	210	230	263	290
A125 - A225 - A325 - A425		161	175	192	205	225	259	285
A167 - A267 - A367 - A467		166	180	197	210	230	263	290
2BNL		171	186	204	218	240	277	306
Scor. Cod. 1000P6 - 1000P8	n.							
Sup. Cod. 993298	n.	2	2	3	3	3	3	3

Maggiorazione movimento a corda - Surcharge for corded systems - Supplément pour tirage
Zuschlag für Schnurbedienung - Suplemento por cuerda - Dodatkowo koszt mechanizmu

	cm	160	180	200	220	250	300	340
Term. Cod. 993001/2		122	122	122	122	122	122	122
Term. Cod. 993043/4		87	87	87	87	87	87	87



SABINA

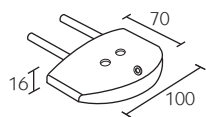

993001A 993002B

Terminale
Finiel
Embout

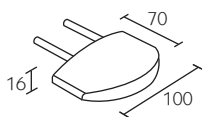

993003C

Endstück
Terminal
Końcówka

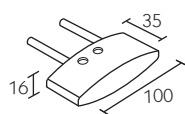

993043A 993044B

Terminale
Finiel
Embout

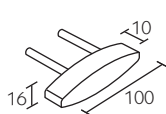

993045C

Endstück
Terminal
Końcówka



208

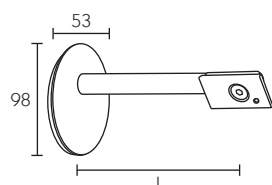

9931--

Supporto
Bracket
Support

Träger
Soporte
Wspornik

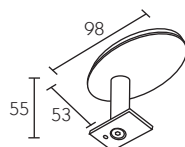

993199

Supporto a soffitto
Ceiling bracket
Support à plafond

Deckenträger
Soporte a techo
Wspornik do sufitu

Cod.	993001A	993002B	993003C
FIN			
25	46,90	46,90	41,10
67	50,80	50,80	44,00

Cod.	993043A	993044B	993045C
FIN			
25	38,50	38,50	23,60
67	42,40	42,40	26,00

Cod.	993109	993119	993129
FIN	90	160	210
25	70,40	73,30	77,50
67	77,20	81,10	85,40

Cod.	993199
FIN	
25	58,60
67	67,40

Components



993298

Aggancio per soffitto
Ceiling hanger for tracks
Accroche pour plafond
Deckenträger für Schiene
Gancho a techo
Dodatkowe zahaczenie dla szyny

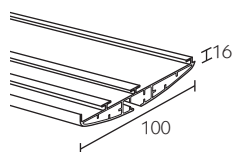

993100

Profilo
Profile
Profil

Profil
Perfil
Profil



1000

Scorrevole
Runner
Glisseur



1001

Gleiter
Corredera
Ślizgacze

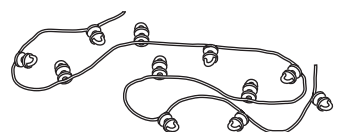

1000--

Scorrevoli
Runners
Glisseurs

Gleiter
Correderas
Ślizgacze

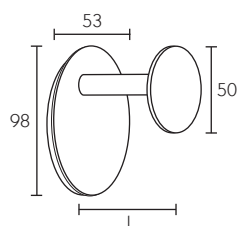

5130--

Fermatenda
Holdback
Porte-embrasse

Raffhalter
Alzapaño
Przytrzymanie firanki

Cod.	993298
FIN	3,70

Cod.	993100
FIN	
25	60,00
39	60,00
67	66,00
BNL	66,00
A1 - A2 - A3 - A4	60,00

Cod.	1000	1001
FIN	0,08	0,61

Cod.	1000P6*	1000P8**
FIN		
Euro/mt	6,74	6,74

* Scorrevoli passo 60 mm - Runners each 60 mm - Glisseurs tous les 60 mm - Gleiter je 60 mm - Correderas cada 60 mm - Ślizgi co 60 mm
** Scorrevoli passo 80 mm - Runners each 80 mm - Glisseurs tous les 80 mm - Gleiter je 80 mm - Correderas cada 80 mm - Ślizgi co 80 mm

Cod.	513078	513088	513098
FIN	100	150	200
25	58,30	62,30	66,30
67	64,10	68,60	73,10
925	58,30	62,30	66,30
967	64,10	68,60	73,10
A125 - A225 - A325 - A425	58,30	62,30	66,30
A167 - A267 - A367 - A467	64,10	68,60	73,10
2BNL	64,10	68,60	73,10
6BNL	64,10	68,60	73,10



ALUMINIUM COLLECTION

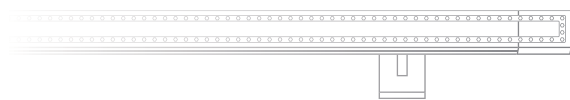

TIFFANY

FINITURE - FINISHES - FINITIONS - FERTIGUNGEN - ACABADOS - WYKOŃCZENIA

67 BNL

81 BXL

NRL



TIFFANY

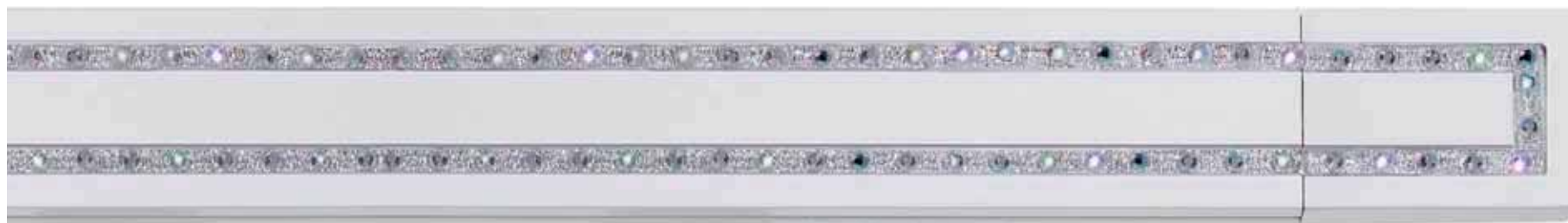

Fin. BNL

Laccato bianco
Lacquered white
Blanc laqué

Lackiert Weiss
Blanco lacado
Lakierowane białe



Fin. 67

Alluminio lucido
Bright aluminium
Aluminium poli

Aluminium poliert
Aluminio pulido
Aluminium polerowane



Fin. BXL

Laccato bordeaux
Lacquered bordeaux
Bordeaux laqué

Lackiert Bordeaux
Bordeaux lacado
Lakierowane bordeaux



TIFFANY

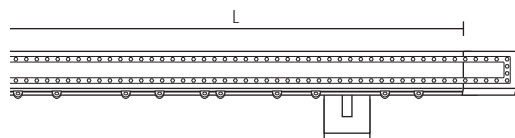

Scorritenda completo a parete
Complete curtain set
Tringle complète pose murale
Komplette Wandgarnitur
Conjunto completo a pared
Karnisz kompletny montaż do ściany

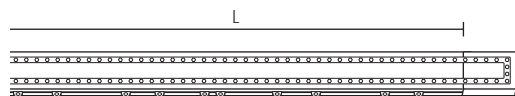

Scorritenda completo a soffitto
Complete curtain set with ceiling bracket
Tringle complète à plafond
Komplette Deckengarnitur
Conjunto completo a techo
Karnisz kompletny do sufitu

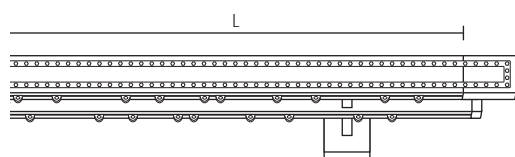

Scorritenda completo doppio a parete
Complete double curtain set
Tringle complète double pose murale
Komplette Doppelgarnitur
Conjunto completo doble a pared
Karnisz podwójny kompletny montaż do ściany

FIN. = Finitura - Finish - Finition - Fertigung - Acabado - Wykonczenie
Scor. = Scorrevoli - Runners - Glisseurs - Gleiter - Correderas - Ślizgacze
Sup. = Supporti - Brackets - Supports - Träger - Soportes - Wsporniki

Cod. 313S02

FIN	cm	120	140	160	180	200	220	250	300	340
67		314	336	356	377	399	419	512	563	604
81		294	315	334	354	375	394	480	529	568
BNL - BXL - NRL		314	336	356	377	399	419	512	563	604
Scor. Cod. 1012	n.	16	20	22	24	28	30	36	42	46
Sup. cm 9	n.	2	2	2	2	2	2	3	3	3

Cod. 313T02

FIN	cm	120	140	160	180	200	220	250	300	340
67		308	330	350	371	393	413	503	554	595
81		289	310	329	349	370	389	472	522	560
BNL - BXL - NRL		308	330	350	371	393	413	503	554	595
Scor. Cod. 1012	n.	16	20	22	24	28	30	36	42	46
Sup.	n.	2	2	2	2	2	2	3	3	3

Cod. 313U02

FIN	cm	120	140	160	180	200	220	250	300	340
67		411	441	469	496	526	553	671	740	795
81		384	412	437	462	490	515	625	689	739
BNL - BXL - NRL		411	441	469	496	526	553	671	740	795
Scor. Cod. 1012	n.	16/16	20/20	22/22	24/24	28/28	30/30	36/36	42/42	46/46
Sup. cm 8	n.	2	2	2	2	2	2	3	3	3



TIFFANY

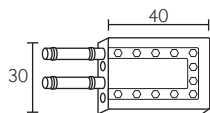

303002

Terminale
Finial
Embout

Endstück
Terminal
Końcówka

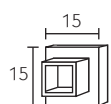

513045

Tappo
Endcap
Bouchon

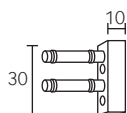

313045

Endkappe
Tapón
Zatyczka

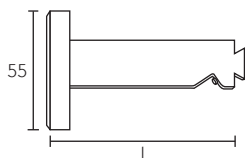

3132--

Supporto
Bracket
Support

Träger
Soporte
Wspornik

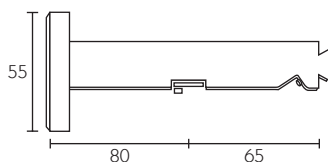

313217

Supporto doppio
Double bracket
Support double

Doppelträger
Soporte doble
Wspornik podwójny

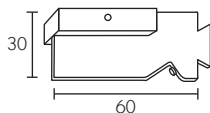

313518

Supporto a soffitto
Ceiling bracket
Support à plafond

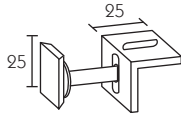

313598

Deckenträger
Soporte a techo
Wspornik do sufitu

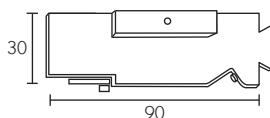

313517

Supporto doppio a soffitto
Double ceiling bracket
Support à plafond double
Decken-Doppelträger
Soporte doble a techo
Wspornik podwójny do sufitu

Cod.	303002SX / DX
FIN	
67	34,80
81	32,80
BNL - BXL - NRL	34,80

Cod.	513045SX / DX	313045SX / DX
FIN		
67	14,20	18,10
81	13,30	14,80
BNL - BXL - NRL	14,20	18,10

Cod.	313218	313228	313238	
FIN	l - mm	90	160	210
67		60,00	63,60	71,60
81		54,50	59,60	67,40
BNL - BXL - NRL		60,00	63,60	71,60

Cod.	313217
FIN	
67	71,60
81	67,40
BNL - BXL - NRL	71,60

Cod.	313518	313598
FIN		
67	57,00	11,40
81	52,00	11,40
BNL - BXL - NRL	57,00	11,40

Cod.	313517
FIN	
67	68,00
81	64,00
BNL - BXL - NRL	68,00



Components

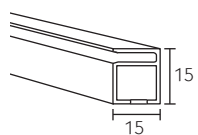

153200
Profilo
Profile
Profil

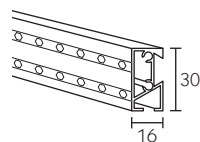

313100
Profil
Perfil
Profil

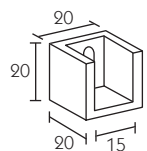

153001
Rosetta a muro
Recess bracket
Naissance murale

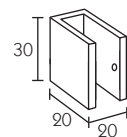

313003
Wandlager
Soporte lateral
Podkładka do muru

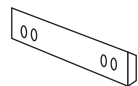

568031
Giunzione
Junction
Jonction
Verbinder
Enchufe
Łącznik



1012
Scorrevole
Runner
Glisseur
Gleiter
Corredera
Ślizgacze



1065

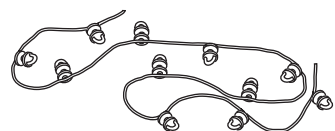

1065--
Scorrevoli
Runners
Glisseurs

Gleiter
Correderas
Ślizgacze

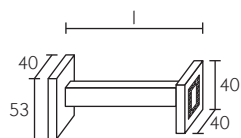

5130--
Fermatenda
Holdback
Porte-embrasse

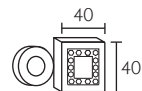

513065
Raffhalter
Alzapaño
Przytrzymanie firanki

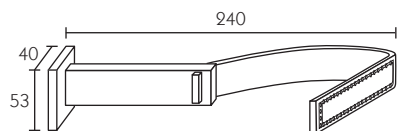

513064
Fermatenda bracciale
Tieback
Porte-embrasse-patère

Umfassender Raffhalter
Alzapaño
Przytrzymanie firany

Cod.	153200	313100
FIN		
67	26,80	93,30
81	20,40	88,80
BNL - BXL - NRL	26,80	93,30

Cod.	153001SX / DX	313003SX / DX
FIN		
67	22,50	23,90
81	18,40	19,50
BNL - BXL - NRL	22,50	23,90

Cod.	568031	1012	1065
FIN			
	19,20	0,80	0,08

Cod.	1065P6*	1065P8**
FIN		
Euro/mt	6,74	6,74

* Scorrevoli passo 60 mm - Runners each 60 mm - Glisseurs tous les 60 mm - Gleiter je 60 mm - Correderas cada 60 mm - Ślizgi co 60 mm
** Scorrevoli passo 80 mm - Runners each 80 mm - Glisseurs tous les 80 mm - Gleiter je 80 mm - Correderas cada 80 mm - Ślizgi co 80 mm

Cod.	513061	513062	513063	513065
FIN	l - mm	100	150	200
67		78,00	81,00	84,00
81		74,00	77,00	80,00
BNL - BXL - NRL		78,00	81,00	84,00

Cod.	513064
FIN	
67	121,00
81	112,00
BNL - BXL - NRL	121,00





03
Cromo
Chrome
Chromé
Messing verchromt
Cromo
Chromowany



67
Alluminio lucido
Bright aluminium
Aluminium poli
Aluminium poliert
Aluminio pulido
Aluminium polerowane



85
Corten



18
Nero base
Basic Black
Noir base
GrundSchwarz
Negro base
Czarny podstawowy



67OR
Alluminio lucido - Oro
Bright aluminium - Gold
Aluminium poli - Or
Aluminium poliert - Gold
Aluminio pulido - Oro
Aluminium polerowane - Złoto



89
Alluminio
Aluminium
Aluminium
Aluminium
Aluminio
Aluminium



25
Alluminio colore acciaio satinato
Anodized aluminium steel color
Aluminium anodisé coloris acier
Aluminium eloxiert Stahl Farbe
Aluminio anodizado color acero
Aluminium w kolorze stali matowe



75
Alluminio satinato verniciato semilucido
Semi-bright painted satin aluminium
Aluminium satiné verni semi-poli
Aluminium satiniert lackiert halb-glaenzend
Aluminio satinado barnizado semipulido
Aluminium satyna lakierowane półpołysk



99
Alluminio bronzo lucido
Aluminium bright bronze
Aluminium bronze poli
Aluminium Bronz glänzend
Aluminio bronce pulido
Aluminium brąz poler



39
Bronzo opaco
Mat bronze
Bronze mat
Bronze matt
Bronce mate
Brąz matowy



81
Alluminio satinato opaco
Satin mat aluminium
Aluminium satiné mat
Aluminium satiniert matt
Aluminio satinado mate
Aluminium satynowy matowy



125
Alluminio colore acciaio satinato - Alluminio lucido
Anodized aluminium steel color - Bright aluminium
Aluminium anodisé coloris acier - Aluminium poli
Aluminium eloxiert Stahl Farbe - Aluminium poliert
Aluminio anodizado color acero - Aluminio pulido
Aluminium w kolorze stali matowe - Al. polerowane



131
Panna
Cream
Crème
Elfenbein
Crema
Kremowy



135
Arancio
Orange
Orange
Orange
Naranja
Pomarańczowy



181
Alluminio satinato opaco - Alluminio lucido
Satin mat aluminium - Bright aluminium
Aluminium satiné mat - Aluminium poli
Aluminium satiniert matt - Poliertes Aluminium
Aluminio satinado mate - Aluminio pulido
Aluminium satynowy matowy - Al. polerowane



132
Rosa
Pink
Rosa
Rosa
Rosa
Różowy



136
Giallo
Yellow
Jaune
Gelb
Amarillo
Żółty



258
Corten - Alluminio colore acciaio satinato
Corten - Anodized aluminium steel color
Corten - Aluminium anodisé coloris acier
Corten - Aluminium eloxiert Stahl Farbe
Corten - Aluminio anodizado color acero
Corten - Aluminium w kolorze stali matowe



133
Azzurro
Blue
Bleu
Blau
Azul
Błękitny



137
Viola
Violet
Violet
Violetto
Violeta
Lila



267
Alluminio lucido - Alluminio colore acciaio satinato
Bright aluminium - Anodized aluminium steel color
Aluminium poli - Aluminium anodisé coloris acier
Aluminium poliert - Aluminium eloxiert Stahl Farbe
Aluminio pulido - Aluminio anodizado color acero
Aluminium polerowane - Al. w kolorze stali matowe



134
Verde
Green
Vert
Grün
Verde
Zielony



167
Alluminio lucido - Alluminio satinato opaco
Bright aluminium - Satin mat aluminium
Aluminium poli - Aluminium satiné mat
Aluminium poliert - Aluminium satiniert matt
Aluminio pulido - Aluminio satinado mate
Aluminium polerowane - Al. satynowy matowy



312
Bianco opaco
Mat white
Blanc mat
Weiss matt
Blanco mate
Biały matowy





325

Cromo - Alluminio colore acciaio satinato
 Chrome - Anodized aluminium steel color
 Chromé - Aluminium anodisé coloris acier
 Messing verchromt - Aluminium eloxiert Stahl Farbe
 Cromo - Aluminio anodizado color acero
 Chromowany - Aluminium w kolorze stali matowe



832

Rosa - Alluminio
 Pink - Aluminium
 Rose - Aluminium
 Rosa - Aluminium
 Rosa - Aluminio
 Różowy - Aluminium



836

Giallo - Alluminio
 Yellow - Aluminium
 Jaune - Aluminium
 Gelb - Aluminium
 Amarillo - Aluminio
 Żółty - Aluminium



367

Cromo - Alluminio lucido
 Chrome - Bright aluminium
 Chromé - Aluminium poli
 Messing verchromt - Aluminium poliert
 Cromo - Aluminio pulido
 Chromowany - Aluminium polerowane



833

Azzurro - Alluminio
 Blue - Aluminium
 Bleu - Aluminium
 Blau - Aluminium
 Azul - Aluminio
 Błękitny - Aluminium



837

Viola - Alluminio
 Violet - Aluminium
 Violet - Aluminium
 Violett - Aluminium
 Violeta - Aluminio
 Lila - Aluminium



678

Corten - Alluminio lucido
 Corten - Bright aluminium
 Corten - Aluminium poli
 Corten - Aluminium poliert
 Corten - Aluminio pulido
 Corten - Aluminium polerowane



834

Verde - Alluminio
 Green - Aluminium
 Vert - Aluminium
 Grün - Aluminium
 Verde - Aluminio
 Zielony - Aluminium



925

Bronzo opaco - Alluminio colore acciaio satinato
 Mat bronze - Anodized aluminium steel color
 Bronze mat - Aluminium anodisé coloris acier
 Bronze matt - Aluminium eloxiert Stahl Farbe
 Bronze mate - Aluminio anodizado color acero
 Brąz matowy - Aluminium w kolorze stali matowe



831

Panna - Alluminio
 Cream - Aluminium
 Crème - Aluminium
 Elfenbein - Aluminium
 Crema - Aluminio
 Kremowy - Aluminium



835

Arancio - Alluminio
 Orange - Aluminium
 Orange - Aluminium
 Orange - Aluminium
 Naranja - Aluminio
 Pomarańczowy - Aluminium

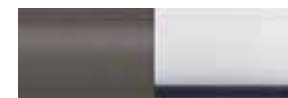

967

Bronzo opaco - Alluminio lucido
 Mat bronze - Bright aluminium
 Bronze mat - Aluminium poli
 Bronze matt - Aluminium poliert
 Bronze mate - Aluminio pulido
 Brąz matowy - Aluminium polerowane



2312

Alluminio colore acciaio satinato - Bianco opaco
Anodized aluminium steel color - Mat white
Aluminium anodisé coloris acier - Blanc mat
Aluminium eloxiert Stahl Farbe - Weiss matt
Aluminio anodizado color acero - Blanco mate
Aluminium w kolorze stali matowe - Biały matowy



3BNL

Laccato bianco - Cromo
Lacquered white - Chrome
Blanc laqué - Chromé
Lackiert Weiss - Verchromt
Blanco lacado - Cromo
Lakierowane białe - Chromowany



NRL

Laccato nero
Lacquered black
Noir laqué
Lackiert Schwarz
Negro lacado
Lakierowane czarne



6312

Alluminio lucido - Bianco opaco
Bright aluminium - Mat white
Aluminium poli - Blanc mat
Aluminium poliert - Weiss matt
Aluminio pulido - Blanco mate
Aluminium polerowane - Biały matowy



6BNL

Laccato bianco - Alluminio lucido
Lacquered white - Bright aluminium
Blanc laqué - Aluminium poli
Lackiert Weiss - Aluminium poliert
Blanco lacado - Aluminio pulido
Lakierowane białe - Aluminium polerowane

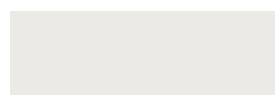

A1

Avorio
Ivory
Ivoire
Elfenbein
Marfil
Kość słoniowa

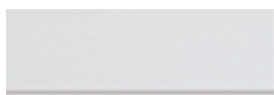

BNL

Laccato bianco
Lacquered white
Blanc laqué
Lackiert Weiss
Blanco lacado
Lakierowane białe



7BNL

Laccato bianco - Alluminio satinato verniciato semilucido
Lacquered white - Semi-bright painted satin aluminium
Blanc laqué - Aluminium satiné verni semi-poli
Lackiert Weiss - Aluminium satiniert lackiert halb-glaenzend
Blanco lacado - Aluminio satinado barnizado semipulido
Lakierowane białe - Aluminium satyna lakierowane półpołysk



A2

Tortora
Dove-colored
Tourterelle
Turteltaubefarbe
Tórtola
Szaro-orzechowy



2BNL

Laccato bianco - Alluminio colore acciaio satinato
Lacquered white - Anodized aluminium steel color
Blanc laqué - Aluminium anodisé coloris acier
Lackiert Weiss - Aluminium eloxiert Stahl Farbe
Blanco lacado - Aluminio anodizado color acero
Lakierowane białe - Aluminium w kolorze stali matowe



BXL

Laccato bordeaux
Lacquered bordeaux
Bordeaux laqué
Lackiert Bordeaux
Bordeaux lacado
Lakierowane bordeaux

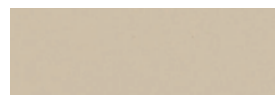

A3

Beige





A4
 Grigio - Cromo
 Gray - Chrome
 Gris - Chromé
 Grau - Messing verchromt
 Gris - Cromo
 Szary - Chromowany



A403
 Grigio - Cromo
 Gray - Chrome
 Gris - Chromé
 Grau - Messing verchromt
 Gris - Cromo
 Szary - Chromowany



A425
 Grigio - Alluminio colore acciaio satinato
 Gray - Anodized aluminium steel color
 Gris - Aluminium anodisé coloris acier
 Grau - Aluminium eloxiert Stahl Farbe
 Gris - Aluminio anodizado color acero
 Szary - Aluminium w kolorze stali matowe



A103
 Avorio - Cromo
 Ivory - Chrome
 Ivoire - Chromé
 Elfenbein - Messing verchromt
 Marfil - Cromo
 Kość słoniowa - Chromowany

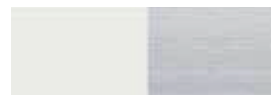

A125
 Avorio - Alluminio colore acciaio satinato
 Ivory - Anodized aluminium steel color
 Ivoire - Aluminium anodisé coloris acier
 Elfenbein - Aluminium eloxiert Stahl Farbe
 Marfil - Aluminio anodizado color acero
 Kość słoniowa - Aluminium w kolorze stali matowe



A167
 Avorio - Alluminio lucido
 Ivory - Bright aluminium
 Ivoire - Aluminium poli
 Elfenbein - Aluminium poliert
 Marfil - Aluminio pulido
 Kość słoniowa - Aluminium polerowane



A203
 Tortora - Cromo
 Dove-colored - Chrome
 Tourterelle - Chromé
 Turteltaubefarbe - Messing verchromt
 Tórtola - Cromo
 Szaro-orzechowy - Chromowany



A225
 Tortora - Alluminio colore acciaio satinato
 Dove-colored - Anodized aluminium steel color
 Tourterelle - Aluminium anodisé coloris acier
 Turteltaubefarbe - Aluminium eloxiert Stahl Farbe
 Tórtola - Aluminio anodizado color acero
 Szaro-orzechowy - Aluminium w kolorze stali matowe



A267
 Tortora - Alluminio lucido
 Dove-colored - Bright aluminium
 Tourterelle - Aluminium poli
 Turteltaubefarbe - Aluminium poliert
 Tórtola - Aluminio pulido
 Szaro-orzechowy - Aluminium polerowane



A303
 Beige - Cromo
 Beige - Chrome
 Beige - Chromé
 Beige - Messing verchromt
 Beige - Cromo
 Beige - Chromowany



A325
 Beige - Alluminio colore acciaio satinato
 Beige - Anodized aluminium steel color
 Beige - Aluminium anodisé coloris acier
 Beige - Aluminium eloxiert Stahl Farbe
 Beige - Aluminio anodizado color acero
 Beige - Aluminium w kolorze stali matowe



A367
 Beige - Alluminio lucido
 Beige - Bright aluminium
 Beige - Aluminium poli
 Beige - Aluminium poliert
 Beige - Aluminio pulido
 Beige - Aluminium polerowane



A467

Grigio - Alluminio lucido
Gray - Bright aluminium
Gris - Aluminium poli
Grau - Aluminium poliert
Gris - Aluminio pulido
Szary - Aluminium polerowane



A481

Grigio - Alluminio satinato opaco
Gray - Satin mat aluminium
Gris - Aluminium satiné mat
Grau - Aluminium satiniert matt
Gris - Aluminio satinado mate
Szary - Aluminium satynowy matowy



D - Z

Noce
Walnut
Noyer
Nußbaum
Nogal
Orzech



A181

Avorio - Alluminio satinato opaco
Ivory - Satin mat aluminium
Ivoire - Aluminium satiné mat
Elfenbein - Aluminium satiniert matt
Marfil - Aluminio satinado mate
Kość słoniowa - Aluminium satynowy matowy



A - H

Ciliegio
Cherry
Merisier
Kirschbaum
Cerezo
Wiśnia



DC

Noce canaletto
Canaletto walnut
Noyer Canaletto
Nussbaum Canaletto
Nogal Canaletto
Orzech Canaletto



A281

Tortora - Alluminio satinato opaco
Dove-colored - Satin mat aluminium
Tourterelle - Aluminium satiné mat
Turteltaubefarbe - Aluminium satiniert matt
Tórtola - Aluminio satinado mate
Szaro-orzechowy - Aluminium satynowy matowy



B - K

Rovere naturale
Natural oak
Chêne
Eiche
Roble natural
Dąb naturalny

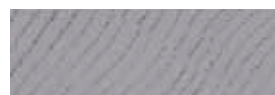

Q

Rovere venatura grigia
Oak grey grain
Chêne grain gris
Eiche graue Flader
Roble con veta gris
Dąb słoje szare



A381

Beige - Alluminio satinato opaco
Beige - Satin mat aluminium
Beige - Aluminium satiné mat
Beige - Aluminium satiniert matt
Beige - Aluminio satinado mate
Beige - Aluminium satynowy matowy



C - Y

Rovere sbiancato
Whitened oak
Chêne lasuré blanc
Gebleichte Eiche
Roble Blanqueado
Dąb rozjaśniony



R

Zebrano



FINITURE - FINISHES - FINITIONS - FERTIGUNGEN - ACABADOS - WYKOŃCZENIA



T
Teak



N
Nero
Black
Noir
Schwarz
Negro
Czarny



GI
Giallo
Yellow
Jaune
Gelb
Amarillo
Żółty



V
Rovere venatura bianca
Oak white grain
Chêne grain blanc
Eiche weisse Flader
Roble con veta blanca
Dąb stoje białe



AR
Arancio
Orange
Orange
Orange
Naranja
Pomarańczowy



RO
Rosso
Red
Rouge
Rot
Rojo
Czerwony



W - J
Wengé



AV
Avorio
Ivory
Ivoire
Elfenbein
Marfil
Kość słoniowa



VA
Verde acqua
Water green
Vert d'eau
Wasser Grün
Verde agua
Zielony Wodny



M
Testa di moro
Dark brown
Tête de maure
Dunkel braun
Marron chocolate
Szaro-orzechowa



BL
Blu
Blue
Bleu
Blau
Azul
Granat



BB
Bufalino bianco
White buff
Buffle blanc
Weisser Büffel
Bufalino blanco
Cielęca biała





BC
 Bufalino marrone
 Brown buff
 Buffle marron
 Brauner Büffel
 Bufalino marrón
 Cielęca brązowa



CB
 Coccodrillo bianco
 White crocodile
 Crocodile blanc
 Weisses Krokodil
 Cocodrilo blanco
 Krokodyl biała



CR
 Coccodrillo rosso
 Red crocodile
 Crocodile rouge
 Rotes Krokodil
 Cocodrilo rojo
 Krokodyl czerwona



BM
 Bufalino testa di moro
 Dark brown buff
 Buffle tête de maure
 Dunkel braun Büffel
 Bufalino marrón chocolate
 Cielęca szaro-orzechowa



CC
 Coccodrillo crema
 Cream crocodile
 Crocodile crème
 Beiges Krokodil
 Cocodrilo crema
 Krokodyl krem



IB
 Intrecciato bianco
 White interlaced
 Entrelacé blanc
 Weiss Kunstleder verflochten
 Entrelazado blanco
 Pleciona biała



BN
 Bufalino nero
 Black buff
 Buffle noir
 Schwarzer Büffel
 Bufalino negro
 Cielęca czarna



CM
 Coccodrillo testa di moro
 Dark brown crocodile
 Crocodile tête de maure
 Dunkel braun Krokodil
 Cocodrilo marrón chocolate
 Krokodyl szaro-orzechowa



IN
 Intrecciato nero
 Black interlaced
 Entrelacé noir
 Schwarz Kunstleder verflochten
 Entrelazado negro
 Pleciona Czarna



BR
 Bufalino rosso
 Red buff
 Buffle rouge
 Roter Büffel
 Bufalino rojo
 Cielęca czerwona



CN
 Coccodrillo nero
 Black crocodile
 Crocodile noir
 Schwarzes Krokodil
 Cocodrilo negro
 Krokodyl czarna



IR
 Intrecciato rosso
 Red interlaced
 Entrelacé rouge
 Rot Kunstleder verflochten
 Entrelazado rojo
 Pleciona Czerwona



FINITURE - FINISHES - FINITIONS - FERTIGUNGEN - ACABADOS - WYKOŃCZENIA



LC
Lucertola
Lizard
Lézard
Eidechse
Lagartija
Jaszczurka



SM
Struzzo testa di moro
Dark brown ostrich
Autruche tête
Dunkel braun Strauss
Avestruz marrón chocolate
Struś szaro-orzechowa



MG
Madreperla grigio
Grey mother of pearl
Nacre grise
Perlmutter grau
Nácar gris
Masa perłowa szara



SP
Serpente
Snake
Serpent
Schlange
Serpiente
Wąż



SN
Struzzo nero
Black ostrich
Autruche noir
Schwarzer Strauss
Avestruz negro
Struś czarna



MR
Madreperla rosa
Pink mother of pearl
Nacre rose
Perlmutter rosa
Nácar rosa
Masa perłowa różowa



SB
Struzzo bianco
White ostrich
Autruche blanc
Weisses Strauss
Avestruz blanco
Struś biała



SR
Struzzo rosso
Red ostrich
Autruche rouge
Roter Strauss
Avestruz rojo
Struś czerwona



SC
Struzzo crema
Cream ostrich
Autruche crème
Beiges Strauss
Avestruz crema
Struś krem



MB
Madreperla bianco
White mother of pearl
Nacre blanche
Perlmutter weiss
Nácar blanco
Masa perłowa biała